

123 Winners Lane • Wylie, TX 75245
800-888-8888
www.bfs.com



DAILY TIME AND JOB TICKET

EMPLOYEE'S NAME		(JOB TICKETS)		NO.		DATE	
STRAIGHT TIME (HRS)	FLAT RATE PRICE	R.O. NO.	OPER. NO.	TIME	OFF	ON	TO

BFS

business forms and supplies

Purchase Orders

Landscape Forms

Business Cards

Invoices

Protection Forms

Office Supplies

Medical Forms

Gift Certificates

Statements

Calendars

HVAC Service Forms

Automotive Forms

DEPOSIT TICKET

DATE _____

DT 411-2
PRINTED IN U.S.A.

CURRENCY	DOLLARS	CENTS
COIN		
CHECKS LIST EACH SEPARATELY		
1		
2		
3		
4		
5		
6		
7		
8		
9		
10		
11		
12		
13		
14		
15		
16		
17		
18		
19		
20		
21		
22		
23		

YOUR COMPANY NAME
CITY, STATE, ZIP CODE
Phone Number

BANK NAME
Bank Address
00-000/0000

ROAD SERVICE

YOUR COMPANY NAME
Address
CITY, STATE, ZIP CODE
Phone Number
Advertising Line

TIME _____

DATE _____

REQUESTED BY _____

PHONE _____

ZIP _____

FINISH	EXTRA PERSON
START	START
TOTAL	TOTAL

VEHICLE I.D. NO. _____

DRIVER _____

SERVICE RENDERED	SPECIAL EQUIPMENT	INDICATE DAMAGED AREAS ON VEHICLE
<input type="checkbox"/> SLING/HOIST TOW	<input type="checkbox"/> SINGLE LINE WINCHING	 KEYS LEFT Y N RADIO Y N
<input type="checkbox"/> WHEEL LIFT	<input type="checkbox"/> DUAL LINE WINCHING	
<input type="checkbox"/> FLAT BED/RAMP	<input type="checkbox"/> SNATCH BLOCKS	
<input type="checkbox"/> START	<input type="checkbox"/> SCOTCH BLOCKS	
<input type="checkbox"/> DOLLY	<input type="checkbox"/> DOLLY	

Gift Certificate

THIS CERTIFICATE ENTITLES _____

TO A GIFT VALUED AT _____ DATE _____

THIS GIFT PRESENTED BY _____ \$ _____

YOUR COMPANY NAME
Address
CITY, STATE, ZIP CODE
Phone Number
Advertising Line

EXPIRES _____

AUTHORIZED SIGNATURE _____

001001

2016-17

Prices effective March 1, 2016

Table of Contents

Artwork Guidelines.....	143	Memos.....	80-82
Automotive Forms.....	4-19	My Choice Creations SM Forms.....	102
Automotive Floor Mats.....	19	Note Pads/Sticky Notes.....	116-117
Banking Supplies.....	95	Ordering Information.....	142
Business Cards.....	103-106	Pest Control Forms.....	22
Business Stationery.....	103-105	Pharmacy & Vet Forms.....	36
Calendars.....	41, 116	Prescription Pads.....	39
Cash Receipt Books.....	16, 66	Presentation Folders.....	97
Checks.....	84-92	Protection Forms.....	28
Collection Forms.....	79	Punch Cards & Note Pads.....	117
Contractor Service Forms.....	42-43	Purchase Orders.....	16, 67-69
Custom Book Covers.....	124	Register Forms.....	55-64
Custom Business Forms.....	132	Register Machines.....	65
Custom Manifold Books.....	123	Rental/DVD/Video Rental.....	35
Custom Multiform Book Quick Reference.....	124	Restaurant/Guest Checks.....	29-33
Custom Multiform Books.....	124-129	Sales Books & Forms.....	50-54
Deposit Tickets.....	92-94	Self Inking Stamps.....	122
Design-A-Form SM	133	Shipping Labels.....	113
Document Jackets.....	96	Shipping/Receiving Forms.....	70-73
Door Hangers.....	107	Special Feature Pricing.....	123
Envelopes.....	98-101	Statements.....	77-78
Florist Forms.....	26	Stock Logos.....	134-136
Form Holders.....	24	Tags.....	108-111
General Repair Forms.....	45	Teller Helper Envelopes.....	95
Gift Certificates.....	114-115	Thermal Rolls.....	83
Gift & Jewelry.....	27	Work Order Forms.....	46-49
Guest Checks/Restaurant.....	29-33	Writing Instruments.....	118-121
Hospitality Forms.....	34		
Human Resource Forms.....	40-41		
HVAC Service Forms.....	21		
Index.....	137-141		
Invoices.....	74-76		
Janitorial Forms.....	23		
Kitchen/Bath Remodeling Forms.....	44		
Labels.....	112-113		
Landscape Forms.....	24-25		
Laser Statements.....	78		
Magnets.....	106		
Marine Repair Forms.....	20		
Medical Forms.....	37-39		

Return Policy

Returns must be approved within 30 days of the purchase date. The returned product is subject to a 10% restocking fee. All returned products must be in saleable condition. Imprinted or Custom orders are non-returnable.

Unconditional Guarantee

Your satisfaction is guaranteed. We are proud of the work we do. If we don't do it right, we'll make it right. Prices, conditions and specifications are subject to change without notice. Colors of products illustrated are approximations.
Printed December 2015 • KC120.

Helpful Icons

Look for these helpful icons throughout the catalog to assist you with features, delivery times and new items now available. Our new products are also featured at-a-glance on pages 4-5.



Ordering made easy

Choose the business product you need. Locate the quantity and number of parts you desire. Add any additional costs for extra imprint lines, booking or padding. Select an ink color and typestyle for your heading imprint and we'll take care of the rest. Please note form sizes are width by height and imprint area is height (number of lines) by width. **Call us today!**

Ink Colors

Select from four ink colors (unless noted otherwise) for your heading imprint at no extra charge. Black ink is standard unless otherwise specified. Colors shown are approximate.



Extra Imprint Lines

Additional lines of type (up to 6 lines) in the body of most imprinted forms are \$18.40(R).

Available typestyles for your company imprint

Please specify typestyle by I.D. code for manual and computer forms and checks. If no typestyle is specified, we will use TB2 - Helvetica Bold for the first line and TB1 - Helvetica for remaining lines.

TA1 Bookman	TF1 Kabel Md
TA2 Bookman Bold	TF2 Kabel Md Bold
TA3 Bookman <i>Italic</i>	TG1 Galliard
TA4 Bookman Bold Italic	TG2 Galliard Bold
TB1 Helvetica	<i>TG3 Galliard Italic</i>
TB2 Helvetica Bold	<i>TG4 Galliard Bold Italic</i>
<i>TB3 Helvetica Italic</i>	TH1 Helvetica Narrow
<i>TB4 Helvetica Bold Italic</i>	TH2 Helvetica Narrow Bold
TC1 Cloister Black	TJ1 Benguait
TD1 Zapf Chancery	TJ2 Benguait Bold
<i>TE1 Brush Script</i>	<i>TJ3 Benguait Italic</i>
<i>TE2 Brush Script Bold Italic</i>	<i>TJ4 Benguait Bold Italic</i>

Delivery times

From the time we receive your order and proofs are approved, we ship:

Blank Products	1 Day	Floor Mats	5 Days
Business Stationery	5 Days	Imprinted Products	3 Days
Custom Products	7 Days	Magnets	7 Days
Design-A-Form SM	3 Days	Presentation Folders	10 Days
Document Jackets	5 Days	Ready-To-Go Forms	7 Days
Door Hangers	5 Days	Stock Products	1 Day
Envelopes	5 Days	Writing Instruments	7 Days

Samples of most forms are available upon request.

Artwork Guidelines on page 143.

New Automotive Forms

RFI-237

DEAL RECAP

Truth in Lending Bank
 Check in Slip Other
 Appraisal Slip
 Odometer Certs
 Power Sheet
 Insurance
 Cash Receipts:
 Amt. _____ No. _____
 Amt. _____ No. _____
 Trade Disc. Lic. Lic. _____
 P.O. Amt. _____
 Good Till _____
 Verified By _____
 Registration
 Title In _____ Due _____
 Source _____

SELLING PRICE (Inc. all Acc.) _____
 SALES TAX _____
 TRADE ALLOWANCE _____
 PAY-OFF _____
 LIENHOLDER _____
 CASH DEPOSIT _____
 C.O.D. _____
 DEFERRED DOWN No. 1 _____
 DEFERRED DOWN No. 2 _____
 DEFERRED DOWN No. 3 _____
 TOTAL CASH DOWN PAYMENT _____
 NUMBER OF PAYMENTS/PAYMENT _____
 NO. DAYS BEFORE 1ST PMT. DATE _____
 ADD-ON INTEREST RATE/APR _____
 LICENSE AND REGISTRATION _____

AMOUNT FINANCED _____ PREMIUM _____ DISCOUNT RATE _____ FINANCE RESERVE _____
 CREDIT LIFE _____ COST _____ RESERVE _____
 CREDIT A & H _____ RESERVE _____

PHYSICAL DAMAGE _____ RESERVE _____
 SERVICE CONTRACTS _____ RESERVE _____
 OTHER _____ RESERVE _____

STOCK # _____ DESCRIPTION _____
 DEAL # _____ I.D. # _____
 CUSTOMER _____ DATE _____
 ADDRESS _____
 SALESMAN 1 _____ MGR. _____
 SALESMAN 2 _____

PRICE OF VEHICLE _____
 COST OF VEHICLE _____
 PACK _____
 TRADE ALLOWANCE _____ (PAYABLE GROSS)
 A.C.V. OF TRADE _____
 OVER-ALLOWANCE _____
 UNDER-ALLOWANCE _____
 COMMISSION No. 1/BONUS _____
 COMMISSION No. 2/BONUS _____
 MANAGER COMM. _____
 PROFIT OF SALE _____

TOTAL INSURANCE RESERVE _____
 TOTAL F & I RESERVE _____
 FINANCE COMMISSION _____
 LAH INSURANCE COMMISSION _____
 SERVICE CONTRACT COMMISSION _____
 PDI COMMISSION _____
 NET F & I RESERVE _____

APPROVED _____ GROSS PROFIT _____

A RFI-237 - Snap-A-Part
Deal Recap, 8½" x 11"

DEAR VALUED CUSTOMER:
 WE HAVE RECEIVED YOUR SPECIAL ORDER PARTS.
 PLEASE ARRANGE TO PICK THEM UP OR CALL OUR SERVICE DEPARTMENT FOR AN APPOINTMENT AS SOON AS PRACTICAL. PLEASE BRING THIS CARD WITH YOU AND THANKS FOR YOUR PATRONAGE.

SPECIFY STOCK # TOY-115-NC

YOUR COMPANY NAME

Address _____
 CITY, STATE, ZIP CODE _____
 Telephone Number _____

CUSTOMER'S CONTACT _____
 NAME _____
 ADDRESS _____
 CITY/STATE _____
 ZIP _____

WORK OR DAYTIME PHONE _____ EVENING OR HOME PHONE _____ REPAIR ORDER _____

ORDER DATE	ESTIMATED ARRIVAL	URGENCY DESCRIPTION
VEHICLE # NUMBER	PRODUCTION DATE	COLOR
QTY	PART NUMBER	DESCRIPTION
		NOTES

1ST NOTIFICATION DATE BY _____ 2ND NOTIFICATION DATE BY _____ DATE CARD MAILED BY _____

WHITE - CUSTOMER COPY CANARY - ORIGINATING DEPT. COPY PINK - PARTS MONITORING
 GOLD-ARRIVAL NOTICE TAG - CUSTOMER NOTIFICATION

FORM TOY11564C

B TOY-115-NC - Snap-A-Part
Toyota Special Parts Order Form, 5½" x 8½"
Imprint area 1" x 4"

Back

SPECIFY STOCK FORM 59

SALESMAN _____ INVOICE NUMBER _____
 STOCK NUMBER _____ NEW USED
 YEAR MAKE MODEL _____
 CUSTOMER NAME _____

VEHICLE SPECIES _____ COMMISSION _____
 INSURANCE PREMIUM _____ COMMISSION _____
 CREDIT LIFE PREMIUM _____ COMMISSION _____
 FINANCE _____ COMMISSION _____
 SALES MANAGER _____ DATE _____

COMMISSION VOUCHER

SPECIFY STOCK # ODOM-103 (3 PART)

ODOMETER DISCLOSURE STATEMENT

Federal law (and State law, if applicable) requires that you state the mileage upon transfer of ownership. Failure to complete or providing a false statement may result in fines and/or imprisonment.

I, _____ (transferor's name, Print)
 state that the odometer now reads _____ (no tenths) miles and to the best of my knowledge that it reflects the actual mileage of the vehicle described below, unless one of the following statements is checked:
 (1) I hereby certify that to the best of my knowledge the odometer reading reflects the amount of mileage in excess of its mechanical limits.
 (2) I hereby certify that the odometer reading is NOT the actual mileage.
 WARNING - ODOMETER DISCREPANCY.

NAME _____ MODEL _____ BODY TYPE _____
 VEHICLE IDENTIFICATION NUMBER _____ YEAR _____

X _____ TRANSFEROR'S SIGNATURE
 PRINTED NAME _____
 TRANSFEROR'S ADDRESS (STREET) _____
 CITY _____ STATE _____ ZIP CODE _____

DATE OF STATEMENT _____
 X _____ TRANSFEREE'S SIGNATURE
 PRINTED NAME _____
 TRANSFEREE'S ADDRESS (STREET) _____
 CITY _____ STATE _____ ZIP CODE _____

FORM 59

C Form 59 - Snap-A-Part
Commission Voucher, 5¼" x 5"

C ODOM-103 - Snap-A-Part
Odometer Disclosure Statement, 5½" x 8½"

A RFI-237 - Deal Recap

Cat. No.	Pts.	Wt. per 1000	Blank Carbonless Lot Prices		
RFI-			100	500	1000
237-2	2	16#	22.43	53.70	74.60

Not available imprinted or numbered. (R)

B TOY-115-NC - Toyota Special Parts Order Form

Cat. No.	Pts.	Wt. per 1000	Carbonless Lot Prices				
TOY-			250	500	1000	2000	5000
115-5-NC	5	30#	134.99	160.32	228.99	434.58	1,080.55
Blank Lot Prices							
115-5-NC	5	30#	122.24	128.67	183.79	351.51	873.00

Last part is white tag/postcard.
 Not available numbered. (R)

C Form 59 - Commission Voucher

Cat. No.	Pts.	Wt. per 1000	Blank Carbonless Lot Prices		
Form 59			500	1000	2000
Form 59	3	10#	41.42	66.35	116.07

Not available imprinted or numbered. (R)

D ODOM-103 - Odometer Disclosure Statement

Cat. No.	Pts.	Wt. per 1000	Blank Carbonless Lot Prices				
ODOM-			250	500	1000	2000	3000
103-3	3	13#	52.70	70.25	100.39	178.37	258.57
103-4	4	17#	65.17	86.89	124.14	220.60	319.84

Not available imprinted or numbered. (R)

YOUR COMPANY NAME
Address
CITY, STATE, ZIP CODE
Phone Number

DATE _____
TECH or R.O. # _____
PHONE # _____
ADVISOR _____

QTY ITEM/PART NUMBER DESCRIPTION

YEAR	MAKE	MODEL	SERIAL NUMBER	TRIM NUMBER

Dear Customer:
It was necessary for us to SPECIAL order the above item(s) for you.
As soon as they arrive you will be notified.
Thank You
By _____

Dear Customer:
The items we ordered for you arrived in our parts dept. today. Please arrange to pick them up or call our service dept. and arrange for an appointment to have them installed as soon as possible. If we do not hear from you within 14 days from this date _____ items will automatically be returned to manufacturer.
NOTE: Please bring this card with you when you pick up your order.
Thank You
By _____

Back (Carbon)
(Carbonless back is white)

E DSA-115, DSA-115-NC - Snap-A-Part
Special Parts Order Form, 5½" x 7"
Imprint area 1" x 3"

E DSA-115 - Special Parts Order Form

Cat. No.	Pts.	Wt. per 1000	Carbonless Lot Prices				
			250	500	1000	2000	5000
DSA-115-3-NC	3	20#	53.05	73.73	105.32	188.27	440.14
DSA-115-4-NC	4	30#	73.73	98.30	140.39	251.06	587.23
Blank Lot Prices							
DSA-115-3-NC	3	20#	51.43	68.58	97.92	175.07	409.42
DSA-115-4-NC	4	30#	72.58	96.79	130.57	233.49	546.09
Carbon Lot Prices							
DSA-115-3	3	20#	44.58	61.87	88.39	154.70	353.51
DSA-115-4	4	30#	61.53	85.44	122.09	222.60	522.21
Blank Lot Prices							
DSA-115-3	3	20#	43.18	57.57	82.18	143.85	328.84
DSA-115-4	4	30#	59.60	79.47	113.50	207.04	485.54

Last part is white tag/postcard on carbonless.
Last part is manila tag/postcard on carbon.
Numbered by request only. (R)

F NC-124-3 FUEL - Fuel Purchase Order Book

Cat. No.	Pts.	Wt. per 5Bks	Carbonless Lot Prices				
			5 Bks	10 Bks	15 Bks	25 Bks	50 Bks
124-3 FUEL	3	6#	108.92	171.17	228.00	332.50	610.83
Blank Lot Prices							
124-3 FUEL	3	6#	101.25	159.50	212.25	309.17	569.17

NOTE:

Company Imprint
Includes your company's name, address and phone number in one of four colors!
For blank forms, subtract 30% unless otherwise listed.

1 Day Blank Shipping **3 Day Imprint**

Starting Number
Choose a six-digit number for your imprinted form, or seven-digit for all register forms at no extra charge! Otherwise, we will start with 001001 or 0001001. Four, five and custom seven-digit numbering available at an additional charge. See page 142 for pricing.

Blank forms will be sequentially numbered unless specified otherwise.

YOUR COMPANY NAME **FUEL PURCHASE ORDER** **001001**
Address CITY, STATE, ZIP CODE Phone Number PURCHASE ORDER SHOW THE NUMBER ON RECEIPTS

TO _____ DATE _____

ADDRESS: _____

QUANTITY DESCRIPTION PRICE AMOUNT

QUANTITY	DESCRIPTION	PRICE	AMOUNT
<input type="checkbox"/> GASOLINE	<input type="checkbox"/> DIESEL		
For Stock #			
<input type="checkbox"/> NEW CAR	<input type="checkbox"/> PARTS		
<input type="checkbox"/> USED CAR	<input type="checkbox"/> SERVICE		

FOR A/C NO. ACCOUNT APPROVED BY _____

YOUR COMPANY NAME **FUEL PURCHASE ORDER** **001002**
Address CITY, STATE, ZIP CODE Phone Number PURCHASE ORDER SHOW THE NUMBER ON RECEIPTS

TO _____ DATE _____

ADDRESS: _____

QUANTITY DESCRIPTION PRICE AMOUNT

QUANTITY	DESCRIPTION	PRICE	AMOUNT
<input type="checkbox"/> GASOLINE	<input type="checkbox"/> DIESEL		
For Stock #			
<input type="checkbox"/> NEW CAR	<input type="checkbox"/> PARTS		
<input type="checkbox"/> USED CAR	<input type="checkbox"/> SERVICE		

FOR A/C NO. ACCOUNT APPROVED BY _____

YOUR COMPANY NAME **FUEL PURCHASE ORDER** **001003**
Address CITY, STATE, ZIP CODE Phone Number PURCHASE ORDER SHOW THE NUMBER ON RECEIPTS

TO _____ DATE _____

ADDRESS: _____

QUANTITY DESCRIPTION PRICE AMOUNT

QUANTITY	DESCRIPTION	PRICE	AMOUNT
<input type="checkbox"/> GASOLINE	<input type="checkbox"/> DIESEL		
For Stock #			
<input type="checkbox"/> NEW CAR	<input type="checkbox"/> PARTS		
<input type="checkbox"/> USED CAR	<input type="checkbox"/> SERVICE		

FOR A/C NO. ACCOUNT APPROVED BY _____

YOUR COMPANY NAME **FUEL PURCHASE ORDER** **001004**
Address CITY, STATE, ZIP CODE Phone Number PURCHASE ORDER SHOW THE NUMBER ON RECEIPTS

TO _____ DATE _____

ADDRESS: _____

QUANTITY DESCRIPTION PRICE AMOUNT

QUANTITY	DESCRIPTION	PRICE	AMOUNT
<input type="checkbox"/> GASOLINE	<input type="checkbox"/> DIESEL		
For Stock #			
<input type="checkbox"/> NEW CAR	<input type="checkbox"/> PARTS		
<input type="checkbox"/> USED CAR	<input type="checkbox"/> SERVICE		

FOR A/C NO. ACCOUNT APPROVED BY _____

F NC-124-3 FUEL - Wire Bound Book
Fuel Purchase Order Book, 8¼" x 11" overall
Receipt size 7½" x 2¾"
Imprint area ½" x 3"
3pt-200 receipts per book



Want to target automotive customers? Ask your sales representative for a complete Automotive Catalog!

C AROCC-665, 365, ARO-672, 372 - Snap-A-Part
Auto Repair Order, 11" x 8 1/2"
Imprint area 1" x 4"

D AROCC-600, ARO-666 - Snap-A-Part
Auto Repair Order, 8 1/2" x 7"
Imprint area 1" x 3"

C AROCC-665, 365, ARO-672, 372 - Auto Repair Order

Cat. No.	Pts.	Wt. per 1000	Carbonless Lot Prices				
			250	500	1000	2000	3000
665-4	4	43#	150.33	241.02	430.30	811.15	1,190.23
365-4*	4	43#	150.33	241.02	430.30	811.15	1,190.23
ARO-		Carbon Lot Prices					
672-4	4	51#	124.44	199.73	356.36	668.88	980.67
372-4*	4	51#	124.44	199.73	356.36	668.88	980.67

*Valid in California, not shown. (R)
Last part is manila tag.

D AROCC-600, ARO-666 - Auto Repair Order

Cat. No.	Pts.	Wt. per 1000	Carbonless Lot Prices				
			250	500	1000	2000	3000
600-3	3	24#	103.12	156.05	269.72	493.43	719.73
ARO-		Carbon Lot Prices					
666-3	3	27#	100.52	151.58	260.57	476.37	693.63

Last part is manila tag. (R)

E ROCC-573, RO-673 - Auto Repair Order

Cat. No.	Pts.	Wt. per 1000	Carbonless Lot Prices				
			250	500	1000	2000	3000
573-3	3	21#	83.98	121.32	200.55	357.50	518.28
RO-		Carbon Lot Prices					
673-3	3	22#	81.17	113.00	181.64	318.29	458.28

Last part is manila tag. No back printing. (R)

E ROCC-573, RO-673 - Snap-A-Part
Auto Repair Order, 8 1/2" x 5 1/2"
Imprint area 1" x 3"

NOTE:

1

Day
Blank
Shipping

3

Day
Imprint



YOUR COMPANY NAME
Address
CITY, STATE, ZIP CODE
Phone Number
Advertising Line

REPAIR ORDER 001001

NAME
ADDRESS
CITY
STATE
ZIP

DATE	DESCRIPTION	QTY	AMOUNT

INSTRUCTIONS		LABOR	COACH OVERTIME	LABOR

ESTIMATE TOTAL

UNLESS OTHERWISE PROVIDED BY LAW, THE SELLER, ABOVE-NAMED, DISCLAIMS ALL WARRANTIES, EXPRESS OR IMPLIED, INCLUDING ANY WARRANTY OF MERCHANTABILITY OR FITNESS FOR A PARTICULAR PURPOSE AND AUTHORIZES THE BUYER TO RETURN ANY UNUSED PRODUCTS TO ANY LOCAL DEALER IN CONNECTION WITH THE SALE OF SAID PRODUCTS.

I HEREBY AUTHORIZE THE ABOVE-NAMED TO BE CONTACTED BY THE SELLER, ABOVE-NAMED, FOR THE PURPOSE OF OBTAINING YOUR SIGNATURE FOR THE PURPOSES OF THE SELLER'S WARRANTY PROGRAM. BY SIGNING THIS FORM, YOU AGREE TO THE TERMS AND CONDITIONS OF THE SELLER'S WARRANTY PROGRAM. IF YOU DO NOT WANT TO SIGN THIS FORM, YOU MAY RETURN IT TO THE SELLER, ABOVE-NAMED, WITHIN 30 DAYS OF THE DATE OF YOUR PURCHASE. ANY UNRECEIVED PRODUCTS WILL BE RETURNED TO YOU.

ZIP CODE
LUB OIL
LUB FLUIDS
LUB CLEAN LUBE
HANDLING
BRAKE ADJ
LUB OIL
LUB FLUIDS
LUB CLEAN LUBE
HANDLING
BRAKE ADJ
LUB OIL
LUB FLUIDS
LUB CLEAN LUBE
HANDLING
BRAKE ADJ

A AROCC-667, ARO-657 - Snap-A-Part Auto Repair Order, 11" x 8½"
Imprint area 1" x 4"

YOUR COMPANY NAME
Address
CITY, STATE, ZIP CODE
Phone Number
Advertising Line 001001

Name
Address
Phone No.
Quantity
Ready-to-Ship

REPAIR ORDER

DATE	DESCRIPTION	QTY	AMOUNT

ESTIMATE TOTAL

I HEREBY AUTHORIZE THE ABOVE-NAMED TO BE CONTACTED BY THE SELLER, ABOVE-NAMED, FOR THE PURPOSES OF THE SELLER'S WARRANTY PROGRAM. BY SIGNING THIS FORM, YOU AGREE TO THE TERMS AND CONDITIONS OF THE SELLER'S WARRANTY PROGRAM. IF YOU DO NOT WANT TO SIGN THIS FORM, YOU MAY RETURN IT TO THE SELLER, ABOVE-NAMED, WITHIN 30 DAYS OF THE DATE OF YOUR PURCHASE. ANY UNRECEIVED PRODUCTS WILL BE RETURNED TO YOU.

B AROCC-645, ARO-655 - Snap-A-Part Auto Repair Order, 8½" x 8½"
Imprint area 1" x 4"

A AROCC-667, ARO-657 - Auto Repair Order

Cat. No.	Pts.	Wt. per 1000	250	500	1000	2000	3000
AROC-							
667-3	3	35#	118.20	191.93	340.55	652.86	966.11
ARO-							
657-3	3	41#	110.08	170.40	297.18	549.28	805.22

Last part is manila tag. (R)

B AROCC-645, ARO-655 - Auto Repair Order

Cat. No.	Pts.	Wt. per 1000	250	500	1000	2000	3000
AROC-							
645-3	3	26#	110.50	174.04	306.12	568.31	833.40
ARO-							
655-2	2	24#	91.57	134.84	225.21	407.21	588.38
655-3	3	32#	105.51	160.73	278.56	510.69	745.42

Last part is manila tag. (R)

C ROCC-558, RO-658 - Auto Repair Order

Cat. No.	Pts.	Wt. per 1000	250	500	1000	2000	3000
ROCC-							
558-3	3	35#	118.20	191.93	340.55	652.86	966.11
RO-							
658-3	3	41#	110.08	170.40	297.18	549.28	805.22

Last part is manila tag. No back printing. (R)

YOUR COMPANY NAME
Address
CITY, STATE, ZIP CODE
Phone Number
Advertising Line

REPAIR ORDER

DATE	DESCRIPTION	QTY	AMOUNT

INSTRUCTIONS

LABOR

COACH OVERTIME

LABOR

ESTIMATE TOTAL

I HEREBY AUTHORIZE THE ABOVE-NAMED TO BE CONTACTED BY THE SELLER, ABOVE-NAMED, FOR THE PURPOSES OF THE SELLER'S WARRANTY PROGRAM. BY SIGNING THIS FORM, YOU AGREE TO THE TERMS AND CONDITIONS OF THE SELLER'S WARRANTY PROGRAM. IF YOU DO NOT WANT TO SIGN THIS FORM, YOU MAY RETURN IT TO THE SELLER, ABOVE-NAMED, WITHIN 30 DAYS OF THE DATE OF YOUR PURCHASE. ANY UNRECEIVED PRODUCTS WILL BE RETURNED TO YOU.

C ROCC-558, RO-658 - Snap-A-Part Auto Repair Order, 11" x 8½"
Imprint area 1" x 4"

NOTE:

Company Imprint

Includes your company's name, address and phone number in one of four colors! For blank forms, subtract 30% unless otherwise listed.

Multi-part Color Sequence

Colors correspond to sequence and number of parts selected in your order unless otherwise specified.

Starting Number

Choose a six-digit number for your imprinted form, or seven-digit for all register forms at no extra charge! Otherwise, we will start with 001001 or 0001001. Four, five and custom seven-digit numbering available at an additional charge. See page 142 for pricing.

Blank forms will be sequentially numbered unless specified otherwise.

Consecutively numbered for strict control.

D AROC-644, ARO-637 - Snap-A-Part
Auto Repair Order, 11" x 8½"
Imprint area 1" x 4"
Designed for use in Florida. (revised 2/08)

E AROC-624, ARO-659 - Snap-A-Part
Auto Repair Order, 11" x 8½"
Imprint area 1" x 4"

D AROC-644, ARO-637 - Auto Repair Order

Cat. No.	Pts.	Wt. per 1000	Carbonless Lot Prices				
			250	500	1000	2000	3000
644-3	3	35#	118.20	191.93	340.55	652.86	966.11
644-4	4	43#	150.33	241.02	430.30	811.15	1,190.23
ARO-			Carbon Lot Prices				
637-3	3	41#	110.08	170.40	297.18	549.28	805.22
637-4	4	51#	124.44	199.73	356.36	668.88	980.67

Last part is manila tag. (R)

E AROC-624, ARO-659 - Auto Repair Order

Cat. No.	Pts.	Wt. per 1000	Carbonless Lot Prices				
			250	500	1000	2000	3000
624-3	3	35#	118.20	191.93	340.55	652.86	966.11
624-4	4	43#	150.33	241.02	430.30	811.15	1,190.23
ARO-			Carbon Lot Prices				
659-3	3	41#	110.08	170.40	297.18	549.28	805.22
659-4	4	51#	124.44	199.73	356.36	668.88	980.67

Last part is manila tag. (R)

F AROC-685, ARO-682 - Auto Repair Order

Cat. No.	Pts.	Wt. per 1000	Carbonless Lot Prices				
			250	500	1000	2000	3000
685-3	3	35#	136.92	211.28	359.68	672.10	984.83
685-4	4	43#	169.88	260.36	449.85	830.28	1,209.05
ARO-			Carbon Lot Prices				
682-3	3	41#	128.70	189.96	316.32	568.72	823.94
682-4	4	51#	143.99	218.97	375.91	687.91	999.60

Last part is manila tag. (R)

F AROC-685, ARO-682 - Snap-A-Part
Auto Repair Order, 11" x 8½"
Imprint area 1" x 4"
Message area 2½" x 4"

NOTE:

1

Day
Blank
Shipping

3

Day
Imprint

AROC-677, 377
ARO-671, 371
Snap-A-Part
 Auto Repair Order, 8 1/2" x 8 1/2"
 Imprint area 1" x 4"

REPAIR ORDER

YOUR COMPANY NAME
 Address
 CITY, STATE, ZIP CODE
 Phone Number
 Advertising Line
 001001

Name _____ Date _____
 Order Written By _____

Address _____
 City _____ Phone _____
 Year and Make _____ Model _____ Motor No. _____
 Chassis _____ License _____
 Operation _____
 INSTRUCTIONS
 [] CHANGE OIL [] FLUSH TRAN. [] FLUSH BFT [] WASH [] POLISH []

ESTIMATE AMOUNT
 REVESED ESTIMATE
 DATE _____ TIME _____
 ESTIMATED BY _____
 APPROVED BY _____
 WORK AUTHORIZED BY _____ DATE PROMISED _____
 DELIVERED TO _____ DATE DELIVERED _____

OFFICE COPY

A AROCC-677, 377, ARO-671, 371 Snap-A-Part Auto Repair Order, 8 1/2" x 8 1/2" Imprint area 1" x 4"

AROC-648 - Snap-A-Part
 Auto Repair Estimate, 11" x 8 1/2"
 Imprint area 1" x 3 3/4"

ALL PARTS ARE NEW UNLESS OTHERWISE INDICATED

YOUR COMPANY NAME
 Address
 CITY, STATE, ZIP CODE
 Phone Number
 Advertising Line
 001001

DATE _____ TIME PROMISED _____
 LUMBER/OPEN _____
 CUSTOMER NO. _____ CHANGE OIL _____
 ADDRESS _____ CITY _____ ZIP CODE _____
 CUSTOMER'S NAME _____
 TELEPHONE _____
 TEL. HOME _____ TEL. OFFICE _____
 TEL. FAX _____
 TEL. CELL _____
 TEL. MOBILE _____
 TEL. OTHER _____

REPAIR ORDER - LABOR INSTRUCTIONS

TOTAL PARTS
 SUBLET PARTS BY AMOUNT

TOTAL SUBJECT REPAIRS
 [] CASH [] GAS, GASOLINE []
 [] INTERNAL [] OILS, OILS []
 [] WASTE [] WASH []
 [] WASTE [] WASH []
 TOTAL GAS + OIL + GREASE _____

ESTIMATED COST OF ABOVE REPAIRS
 DO YOU WANT THE OLD PARTS? YES [] NO []
 ESTIMATE \$ _____
 DATE _____ TIME _____
 ESTIMATED BY _____
 APPROVED BY _____
 WORK AUTHORIZED BY _____ DATE PROMISED _____
 DELIVERED TO _____ DATE DELIVERED _____

OFFICE COPY

B AROCC-648 - Snap-A-Part Auto Repair Estimate, 11" x 8 1/2" Imprint area 1" x 3 3/4"

AROC-374, ARO-373 - Snap-A-Part
 Auto Repair Order, 11" x 8 1/2"
 Imprint area 1" x 3 3/4"

REPAIR ORDER

YOUR COMPANY NAME
 Address
 CITY, STATE, ZIP CODE
 Phone Number
 Advertising Line
 001001

Name _____ Date _____
 Order Written By _____

Address _____
 City _____ Phone _____
 Year and Make _____ Model _____ Motor No. _____
 Chassis _____ License _____
 Operation _____
 INSTRUCTIONS
 [] CHANGE OIL [] FLUSH TRAN. [] FLUSH BFT [] WASH [] POLISH []

ESTIMATE AMOUNT
 REVESED ESTIMATE
 DATE _____ TIME _____
 ESTIMATED BY _____
 APPROVED BY _____
 WORK AUTHORIZED BY _____ DATE PROMISED _____
 DELIVERED TO _____ DATE DELIVERED _____

OFFICE COPY

C AROCC-374, ARO-373 - Snap-A-Part Auto Repair Order, 11" x 8 1/2" Imprint area 1" x 3 3/4"

A AROCC-677, 377, ARO-671, 371 - Auto Repair Order

Cat. No.	Pts.	Wt. per 1000	Carbonless Lot Prices				
			250	500	1000	2000	3000
677-4	4	35#	161.88	260.68	416.47	751.66	1,096.73
377-4*	4	35#	161.88	260.68	416.47	751.66	1,096.73
ARO-			Carbon Lot Prices				
671-4	4	40#	118.30	186.84	326.82	614.48	903.08
371-4*	4	40#	118.30	186.84	326.82	614.48	903.08

*Valid in California, not shown. Last part is manila tag. (R)

B AROCC-648 - Auto Repair Estimate

Cat. No.	Pts.	Wt. per 1000	Carbonless Lot Prices				
			250	500	1000	2000	3000
648-4	4	46#	150.33	241.02	430.30	811.15	1,190.23

Valid in California. Last part is manila tag. (R)

C AROCC-374, ARO-373 - Auto Repair Order

Cat. No.	Pts.	Wt. per 1000	Carbonless Lot Prices				
			250	500	1000	2000	3000
374-4	4	43#	150.33	241.02	430.30	811.15	1,190.23
ARO-			Carbon Lot Prices				
373-4	4	51#	124.44	199.73	356.36	668.88	980.67

Valid in California. Last part is manila tag. (R)

NOTE:

Company Imprint

Starting Number

Includes your company's name, address and phone number in one of four colors! For blank forms, subtract 30% unless otherwise listed.

Multi-part Color Sequence

Colors correspond to sequence and number of parts selected in your order unless otherwise specified.

Choose a six-digit number for your imprinted form, or seven-digit for all register forms at no extra charge! Otherwise, we will start with 001001 or 0001001. Four, five and custom seven-digit numbering available at an additional charge. See page 142 for pricing.

Blank forms will be sequentially numbered unless specified otherwise.

ESTIMATE AND REPAIR ORDER

YOUR COMPANY NAME
Address
CITY, STATE, ZIP CODE
Phone Number
Advertising Line

SHEET NO. _____ OF _____ SHEETS **001001**

Car Owner _____ Address _____ City _____ State _____ Zip _____
Business Phone _____ Home Phone _____
Year _____ Make _____ Model _____ Type _____ Lic. # _____ Mfr. Code _____
VIN# _____ Adjuster _____ Phone _____

Insurance Co. _____ Policy No. _____
ID _____ Adjuster _____
YEAR _____ MAKE _____ MODEL _____ LICENSE NO. _____ ODOMETER _____
DESCRIPTION OF LABOR OR MATERIAL _____ LABOR HRS. _____ PARTS _____ MISC. _____ SUBLET \$ _____

Estimate Amount \$ _____
Revised Estimate \$ _____
Customer's O.K. By _____
Time _____ Date Called _____ By Whom _____
Deposit \$ _____
Chgs. if not Reported \$ _____
TAX _____
ADVANCE CHARGES _____
TOTAL \$ _____

MS. OF LABOR @ \$ _____ PER HR. \$ _____
PARTS \$ _____
MATERIALS \$ _____
SUBLET \$ _____
TAX \$ _____
ADVANCE CHARGES \$ _____
TOTAL \$ _____

Thank You

REPAIR ESTIMATE

YOUR COMPANY NAME
Address
CITY, STATE, ZIP CODE
Phone Number
Advertising Line

VOPR AFTER 30 DAYS **001001**

Car Owner _____ Address _____ City _____ State _____ Zip _____
Business Phone _____ Home Phone _____
Year _____ Make _____ Model _____ Type _____ Lic. # _____ Mfr. Code _____
VIN# _____ Adjuster _____ Phone _____

Insurance Co. _____ Policy No. _____
ID _____ Adjuster _____
YEAR _____ MAKE _____ MODEL _____ LICENSE NO. _____ ODOMETER _____
DESCRIPTION OF LABOR OR MATERIAL _____ LABOR HRS. _____ PARTS _____ MISC. _____ SUBLET \$ _____

Estimate Amount \$ _____
Revised Estimate \$ _____
Customer's O.K. By _____
Time _____ Date Called _____ By Whom _____
Deposit \$ _____
Chgs. if not Reported \$ _____
TAX _____
ADVANCE CHARGES _____
TOTAL \$ _____

MS. OF LABOR @ \$ _____ PER HR. \$ _____
PARTS \$ _____
MATERIALS \$ _____
SUBLET \$ _____
TAX \$ _____
ADVANCE CHARGES \$ _____
TOTAL \$ _____

Thank You

D EROCC-560, ERO-660 - Snap-A-Part
Estimate and Repair Order, 8½" x 11"
Imprint area 1" x 4"

E RECC-621, RE-661 - Snap-A-Part
Repair Estimate, 8½" x 11"
Imprint area 1" x 4"

D EROCC-560, ERO-660 - Estimate and Repair Order

Cat. No.	Pts.	Wt. per 1000	Carbonless Lot Prices				
			250	500	1000	2000	3000
560-2	2	16#	94.07	137.54	232.18	418.96	606.58
560-3	3	25#	117.47	184.03	323.80	603.25	880.72
ERO-			Carbon Lot Prices				
660-2	2	19#	86.58	121.52	202.85	362.49	520.05
660-3	3	29#	100.93	153.04	262.24	481.16	698.20

Envelopes available on page 100. (9906) (R)

E RECC-621, RE-661 - Repair Estimate

Cat. No.	Pts.	Wt. per 1000	Carbonless Lot Prices				
			250	500	1000	2000	3000
621-3	3	25#	117.47	184.03	323.80	603.25	880.72
RE-			Carbon Lot Prices				
661-3	3	29#	100.93	153.04	262.24	481.16	698.20

Envelopes available on page 100. (9906) (R)

F ES-697 - Estimate

Cat. No.	Pts.	Wt. per 1000	Carbonless Lot Prices				
			250	500	1000	2000	3000
697-2	2	16#	94.07	137.54	232.18	418.96	606.58

Envelopes available on page 100. (9906) (R)

NOTE:

1 Day Blank Shipping

3 Day Imprint

ESTIMATE

YOUR COMPANY NAME
Address
CITY, STATE, ZIP CODE
Phone Number
Advertising Line

SHEET NO. _____ OF _____ SHEETS **001001**

Car Owner _____ Address _____ City _____ State _____ Zip _____
Business Phone _____ Home Phone _____
Year _____ Make _____ Model _____ Type _____ Lic. # _____ Mfr. Code _____
VIN# _____ Adjuster _____ Phone _____

Insurance Co. _____ Policy No. _____
ID _____ Adjuster _____
YEAR _____ MAKE _____ MODEL _____ LICENSE NO. _____ ODOMETER _____
DESCRIPTION OF LABOR OR MATERIAL _____ LABOR HRS. _____ PARTS _____ MISC. _____ SUBLET \$ _____

Estimate Amount \$ _____
Revised Estimate \$ _____
Customer's O.K. By _____
Time _____ Date Called _____ By Whom _____
Deposit \$ _____
Chgs. if not Reported \$ _____
TAX _____
ADVANCE CHARGES _____
TOTAL \$ _____

MS. OF LABOR @ \$ _____ PER HR. \$ _____
PARTS \$ _____
MATERIALS \$ _____
SUBLET \$ _____
TAX \$ _____
ADVANCE CHARGES \$ _____
TOTAL \$ _____

Thank You

F ES-697 - Snap-A-Part
Estimate, 8½" x 11"
Imprint area 1" x 4"

SMOG CHECK WORK ORDER

YOUR COMPANY NAME
Address
CITY, STATE, ZIP CODE
Phone Number
Advertising Line

NAME: 001001
ADDRESS: _____
CITY: _____ PHONE: _____ DATE OF ORDER: _____
CUSTOMER'S ORDER NO. / VIN NO.: _____
YEAR, MAKE AND MODEL: _____
LIC. PLATE # _____ MOTOR # _____
ODOMETER _____
ORDER WRITTEN BY: _____
RETAIN PARTS DESTROY PARTS
LICENSE NUMBER _____ DATE PROMISED _____

LABOR INSTRUCTIONS

GROSS VEH. WEIGHT _____ IM SMOG INSPECTION _____
CERT. NO. _____ IM SMOG CERTIFICATE _____

EMISSION CHECK OFF

PCV	TWC
TAC	EGR
MS	SPK
EVAP	CCO
FR	INJ
OC	OXY
AS	WRG
TWC	VAC
APP	OTH

CASH CHECK CHARGE

TOTAL LABOR _____
CERTIFICATE _____
PARTS _____
SUB TOTAL _____
SALES TAX _____
LABOR _____
TOTAL AMOUNT _____

SWO-643-4 PRINTED IN U.S.A. OFFICE COPY

D SWOCC-640, SWO-643 - Snap-A-Part
Smog Check Work Order, 8 1/2" x 8 1/2"
Imprint area 1" x 3"

YOUR COMPANY NAME
Address
CITY, STATE, ZIP CODE
Phone Number
Advertising Line

NAME: 001001
ADDRESS: _____
CITY, STATE, ZIP: _____
PHONE: () _____
FAX: () _____
DATE: _____

SMOG TEST ONLY INVOICE

VEHICLE YEAR, MAKE AND MODEL: _____ CUSTOMER P.O. # _____
LIC. PLATE # _____ MOTOR # _____
CITY STATE ZIP: _____
ODOMETER _____
ORDER WRITTEN BY: _____
VIN: _____
TEST TYPE: PRENATAL CHARGE OF OWNERSHIP P-TEST DEF. F-TEST M-TEST S-TEST T-TEST U-TEST V-TEST W-TEST X-TEST

SMOG TEST / EMISSION CHECK OFF

PCV	C/I
TAC	EGR
CAT	SPK
EVAP	CCO
FR	INJ
OC	OXY
AS	WRG
TWC	VAC
APP	OTH

SMOG TEST YES NO
CERTIFICATE # _____
ELECTRONIC TRANSFER FEE (E.T.F.) _____
RETEST _____
GAS CAP _____

TOTAL WORK _____
CERTIFICATE _____
E.T.F. _____
SUB TOTAL _____
SALES TAX _____
GRAND TOTAL _____

DATE: _____

E STOICC-341 - Snap-A-Part
Smog Test Only Invoice, 8 1/2" x 7"
Imprint area 1" x 5"

D SWOCC-640, SWO-643 - Smog Check Work Order

Cat. No.	Pts.	Wt. per 1000	Carbonless Lot Prices					
			250	500	1000	2000	3000	
SWOCC-								
640-4	4	31#	161.88	260.68	416.47	751.66	1,096.73	
SWO-			Carbon Lot Prices					
643-4	4	32#	118.30	186.84	326.82	614.48	903.08	

Valid in California. (R)
Last part is manila tag.

E STOICC-341 - Smog Test Only Invoice

Cat. No.	Pts.	Wt. per 1000	Carbonless Lot Prices				
			250	500	1000	2000	3000
STOICC-							
341-3	3	16#	99.06	148.56	252.36	460.88	669.19

Valid in California. (R)

F SCCACC-385, SCCA-375 - Smog Control Order

Cat. No.	Pts.	Wt. per 1000	Carbonless Lot Prices				
			250	500	1000	2000	3000
SCCACC-							
385-4	4	43#	150.33	241.02	430.30	811.15	1,190.23
SCCA-			Carbon Lot Prices				
375-4	4	51#	124.44	199.73	356.36	668.88	980.67

Valid in California. (R)
Last part is manila tag.

EMMISSIONS SERVICE ORDER

YOUR COMPANY NAME
Address
CITY, STATE, ZIP CODE
Phone Number
Advertising Line

NAME: 001001
ADDRESS: _____
CITY, STATE, ZIP: _____
PHONE: () _____
FAX: () _____
DATE: _____

LABOR INSTRUCTIONS

IM SMOG INSPECTION _____
IM SMOG CERTIFICATE # _____

LABOR _____
TOTAL LABOR _____
PARTS _____
SUB TOTAL _____
SALES TAX _____
TOTAL AMOUNT _____

THANK YOU

FORM #SCCACC-4 OFFICE COPY

F SCCACC-385, SCCA-375 - Snap-A-Part
Smog Control Order, 8 1/2" x 11"
Imprint area 1" x 4"



Valvoline **Multi-Point Vehicle Inspection** **Mobil**

YOUR COMPANY NAME
Address
CITY, STATE, ZIP CODE
Phone Number
Advertising Line

Customer Name: _____ Work Order: _____ Mileage: _____ Date: ____/____/____
Year: _____ Make: _____ Model: _____ LIC # _____
VIN: _____ Unit Number: _____ Technician: _____

CHECKED AND OKAY AT THIS TIME **MAY REQUIRE FUTURE ATTENTION** **REQUIRES IMMEDIATE ATTENTION**

Components	TOPSIDE			Condition	NOTES/COMMENTS
	OK	ATTN	IMM		
Lights					
Wiper Blades					
Belts & Hoses					
Battery					
Engine Air Filter					
Cabin Air Filter					
Other					
Fluids					
Transmission					
Engine Oil					
Coolant					
Power Steering					
Brake Fluid					
Washer Fluid					
Other					
Components					
Drain Plugs					
Steering and Suspension					
Power Train					
Brakes					
Fuel Filter					
Exhaust					
Fluids					
Manual Transmission					
Transfer Case					
Rear Differential					
Front Differential					
Grease Fittings					
30,000 Service					
Other					
COURTESIES					
Set Tire Pressure					
Install Skiver					
Other					

Left Front Tread Wear: _____ Tread Depth: _____ Tire Pressure: _____ Brake Pads: _____ Outer: _____ Inner: _____

Right Front Tread Wear: _____ Tread Depth: _____ Tire Pressure: _____ Brake Pads: _____ Outer: _____ Inner: _____

Left Rear Tread Wear: _____ Tread Depth: _____ Tire Pressure: _____ Brake Pads: _____ Outer: _____ Inner: _____

Right Rear Tread Wear: _____ Tread Depth: _____ Tire Pressure: _____ Brake Pads: _____ Outer: _____ Inner: _____

A MPVCC-690 - Snap-A-Part
Multi-Point Vehicle Inspection, 8½" x 11"
Imprint area 1" x 8"
Imprint just your company information or add the brand logos of your choice.

EMISSION CONTROL WORK ORDER **YOUR COMPANY NAME** **001001**

Address
CITY, STATE, ZIP CODE
Phone Number
Advertising Line

DATE: _____ TIME: _____
DATE RECEIVED: _____
DATE: _____ TIME: _____
DATE RECEIVED: _____

ESTIMATE: CUSTOMER APPROVED REPAIR OF A COPY HEREBY _____ YES _____ NO _____
INSPECTION FEE: _____ RETURN OLD PARTS: YES NO _____
TOTAL ESTIMATE: _____

ESTIMATED COST: _____
LIC. REC. SEC. CHG. STATE: _____
GROSS AMT. _____ ORIGINAL

ALL PARTS ARE NEW UNLESS OTHERWISE DESIGNATED. REPAIR ORDER LATEST RETENTION. INTERNAL

ESTIMATE: _____
DATE: _____
GROSS AMT. _____
LIC. REC. SEC. CHG. STATE: _____
GROSS AMT. _____ ORIGINAL

B ECO-674 - Snap-A-Part
Emission Control Work Order, 8½" x 8½"
Imprint area 1" x 4"

A MPVCC-690 - Multi-Point Vehicle Inspection

Cat. No.	MPVCC-	Pts.	Wt. per 1000	Carbonless Lot Prices				
				250	500	1000	2000	2500
690-2	2	20#	174.95	233.25	374.85	633.10	749.70	1,416.10
690-3	3	22#	199.90	308.20	533.10	916.30	1,132.90	2,165.80
690-4	4	27#	249.90	374.85	683.05	1,249.50	1,499.40	2,932.16

B ECO-674 - Emission Control Work Order

Cat. No.	ECO-	Pts.	Wt. per 1000	Carbon Lot Prices			
				250	500	1000	2000
674-3	3	32#	91.36	132.65	221.68	398.48	576.63
674-4	4	40#	101.97	154.60	266.29	487.19	709.54

C TROCC-633, TRO-638 - Transmission Repair Order

Cat. No.	TROCC-	Pts.	Wt. per 1000	Carbonless Lot Prices			
				250	500	1000	2000
633-4	4	43#	150.33	241.02	430.30	811.15	1,190.23
638-4	4	51#	124.44	199.73	356.36	668.88	980.67

Last part is manila tag.

NOTE:

Company Imprint
Includes your company's name, address and phone number in one of four colors! For blank forms, subtract 30% unless otherwise listed.

Multi-part Color Sequence
Colors correspond to sequence and number of parts selected in your order unless otherwise specified.

Starting Number
Choose a six-digit number for your imprinted form, or seven-digit for all register forms at no extra charge! Otherwise, we will start with 001001 or 0001001. Four, five and custom seven-digit numbering available at an additional charge. See page 142 for pricing.

Blank forms will be sequentially numbered unless specified otherwise.

TRANSMISSION REPAIR ORDER **YOUR COMPANY NAME** **001001**

Address
CITY, STATE, ZIP CODE
Phone Number
Advertising Line

DATE: _____ TIME: _____
DATE RECEIVED: _____
DATE: _____ TIME: _____
DATE RECEIVED: _____

ESTIMATE: CUSTOMER APPROVED REPAIR OF A COPY HEREBY _____ YES _____ NO _____
INSPECTION FEE: _____ RETURN OLD PARTS: YES NO _____
TOTAL ESTIMATE: _____

ESTIMATED COST: _____
LIC. REC. SEC. CHG. STATE: _____
GROSS AMT. _____ ORIGINAL

ALL PARTS ARE NEW UNLESS OTHERWISE DESIGNATED. REPAIR ORDER LATEST RETENTION. INTERNAL

ESTIMATE: _____
DATE: _____
GROSS AMT. _____
LIC. REC. SEC. CHG. STATE: _____
GROSS AMT. _____ ORIGINAL

C TROCC-633, TRO-638 - Snap-A-Part
Transmission Repair Order, 11" x 8½"
Imprint area 1" x 3¼"

YOUR COMPANY NAME
Address
CITY, STATE, ZIP CODE
Phone Number
Advertising Line

Start of Delivery	Gallons	Tenths
Gallons	End of Delivery	Tenths
Gallons	Start of Delivery	Tenths

CASH CHARGE DATE _____
SOLD TO _____
ADDRESS _____
TANK TRUCK SALESWOMAN _____ TIME _____ A. M. P. M.
Your Sale Number _____ GALLON READING FINISH _____ 00hrs
Previous Sale Number _____ GALLON READING START _____ 00hrs

GALLONS DELIVERED	PRODUCT	GALS.	PRICE	AMOUNT

No. 001001 TAX _____ TOTAL _____
Customer sign here after delivery only-Above gallons delivered

ROBEK-Insert Bottom First
NEPLUNG-Insert Bottom First
NEPLUNG-Insert Bottom First
NEPLUNG-Insert Bottom First
ROBEK-Insert Bottom First
ROBEK-Insert Bottom First

A FMTCC-898, FMT-897 - Snap-A-Part
Fuel Meter Ticket, 4 1/8" x 7 3/4"
Imprint area 1" x 3 1/2"

YOUR COMPANY NAME
Address
CITY, STATE, ZIP CODE
Telephone Number

WE OWE

NAME _____ STOCK # _____ NEW USED

ADDRESS _____ YEAR _____ MAKE _____

CITY _____ STATE _____ ZIP _____ MODEL _____

PHONE _____ VIN _____

SALESPERSON _____ DEL. DATE _____

CITY	NAME OF ITEM OR SERVICE OWED	PART	LABOR

I hereby accept this WE OWE with the understanding that it is valid for only (30) THIRTY DAYS FROM DATE OF ISSUANCE, and that I must make an ADVANCE APPOINTMENT WITH THE SERVICE DEPARTMENT before the above work can be performed.
(FOR APPOINTMENT CALL SERVICE DEPT.)
DATE _____ APPROVED _____
CUSTOMER _____ MGR. _____

B SA-1506 - Snap-A-Part
We Owe, 8 1/2" x 5 5/8"
Imprint area 3/4" x 4 3/8"

WEEKLY SERVICE APPOINTMENTS AND INSTALLATION SCHEDULE

THURSDAY	FRIDAY	SATURDAY

MONDAY	TUESDAY	WEDNESDAY

C 9927
Weekly Service Appointment Pad,
22" x 17"
52 pages per pad

A FMTCC-898, FMT-897 - Fuel Meter Ticket

Cat. No.	Pts.	Wt. per 1000	250	500	1000	2000	3000	5000
898-3	3	12#	79.63	109.45	175.00	305.70	429.75	668.25
FMT- Carbon Lot Prices								
897-3	3	16#	72.50	100.10	156.70	269.60	381.00	596.00

Part one not self-contained. Call for pricing if required. (R)
Last part is manila tag.

B SA-1506 - We Owe

Cat. No.	Pts.	Wt. per 1000	250	500	1000	2000	5000	10000
1506-3	3	21#	58.01	80.57	115.10	205.47	475.48	922.41
1506-4	4	27#	86.18	114.90	164.13	311.83	740.57	1,407.14

Last part is white tag. (R)

C 9927 - Weekly Service Appointment Pad

Cat. No.	Wt. per Pad	1 Pads	2 Pads	3 Pads	4 Pads	5 Pads
9927	3#	39.57	54.44	65.99	79.20	92.30

Not available imprinted or numbered. (R)

D OARE-9920 - Overnight Auto Repair Envelope

Cat. No.	Wt. per 1000	250	500	1000	2000	4000
9920	24#	114.56	152.83	212.11	361.35	648.80

Custom envelopes available on page 98. (9831) (R)

NOTE:



YOUR COMPANY NAME
Address
CITY, STATE, ZIP CODE
Phone Number
Advertising Line

TO OUR EARLY MORNING OR LATE EVENING SERVICE CUSTOMERS

- WRITE YOUR ORDER ON THIS ENVELOPE.
- LEAVE YOUR CAR ON OUR LOT AND LOCKED.
- PLACE YOUR KEYS IN THE ENVELOPE.
- DROP ENVELOPE IN MAIL SLOT.

NAME _____ YEAR _____

ADDRESS _____ HOME/WORK _____

CITY _____ COLOR _____

STATE _____ ZIP _____ SERVICE NO. _____

HOW TO USE _____

BUSINESS PHONE _____ SERVICE YOU WILL CALL FOR YOUR CAR? (CALL) (FAX)

USE THIS HANDY CHECK LIST

<input type="checkbox"/> Oil/Transmission	<input type="checkbox"/> NEW INSPECTION	<input type="checkbox"/> Wash/Wax	<input type="checkbox"/> NEW BRAKES
<input type="checkbox"/> Change Engine Oil	<input type="checkbox"/> Adjust Brakes	<input type="checkbox"/> Clean Interior	<input type="checkbox"/> Tune Engine
<input type="checkbox"/> Change Oil Filter	<input type="checkbox"/> Clean Spark Plugs	<input type="checkbox"/> Wash/Detail	<input type="checkbox"/> Check Tire Pressure
<input type="checkbox"/> Change Transmission Oil	<input type="checkbox"/> Oil Leaks - Front	<input type="checkbox"/> Wash/Detail	<input type="checkbox"/> Check Tire Pressure
<input type="checkbox"/> Repair Front Wheel Bearings	<input type="checkbox"/> Oil Leaks - Rear	<input type="checkbox"/> Wash/Detail	<input type="checkbox"/> Check Tire Pressure
<input type="checkbox"/> Tune Engine	<input type="checkbox"/> Check Brakes	<input type="checkbox"/> Wash/Detail	<input type="checkbox"/> Check Tire Pressure
<input type="checkbox"/> Replace Brakes	<input type="checkbox"/> Body Damage	<input type="checkbox"/> Wash/Detail	<input type="checkbox"/> Check Tire Pressure
<input type="checkbox"/> Other Work (Specify)	<input type="checkbox"/> Unusable	<input type="checkbox"/> Wash/Detail	<input type="checkbox"/> Check Tire Pressure

I hereby authorize the above repair work to be done with the necessary material, and hereby grant you and/or your employees permission to operate on my car as described in above. I agree to be held responsible for the cost of making and/or repairs. An express mechanic's lien is hereby acknowledged in favor of the service department in the amount of repair and/or service charges. Our liability is not responsible for the condition of parts or vehicles in parts otherwise beyond our control for loss or damage to vehicle or articles left in vehicle in case of fire, theft or any other cause beyond our control.

Please Sign Here _____

D OARE-9920
Overnight Auto Repair Envelope, 6" x 9"
Imprint area 1 1/4" x 5 1/4"

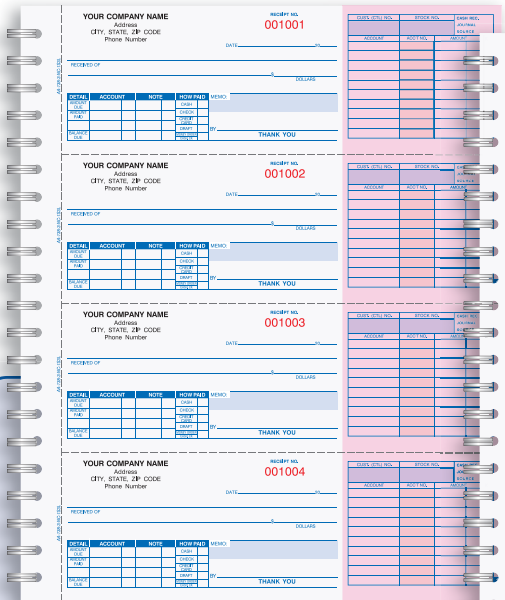

A AA-138 - Wire Bound Book
 Cash Receipt Book, 8 1/4" x 11" overall
 Receipt size Pt 1: 5 1/8" x 2 3/4", Pt 2 & 3: 8 1/8" x 2 3/4"
 Imprint area 9/16" x 2 1/2"
 Pt-1 does not have "Over \$10,000 file form IRS-8300"
 3 pt-200 receipts per book
 4 pt-200 receipts per book

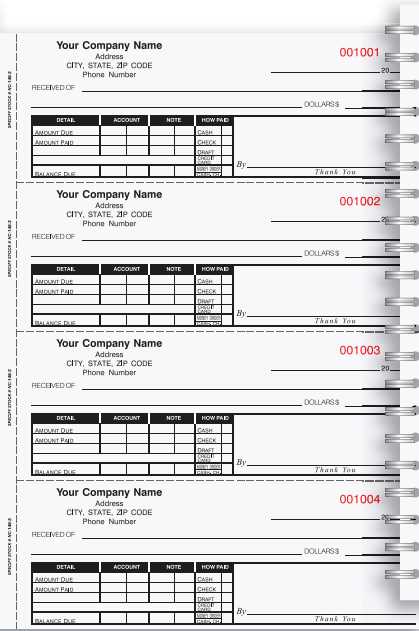

B NC-146 - Wire Bound Book
 Cash Receipt Book, 8 1/4" x 11" overall
 Receipt size 7 1/2" x 2 3/4"
 Imprint area 9/16" x 4 1/8"
 2 pt-200 receipts per book
 3 pt-200 receipts per book

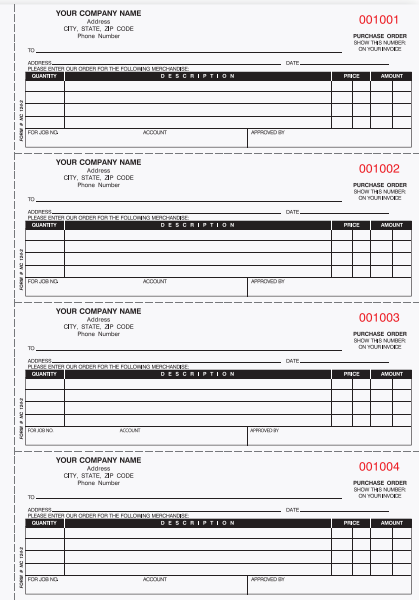

C NC-124 - Wire Bound Book
 Purchase Order Book, 8 1/4" x 11" overall
 Receipt size 7 1/2" x 2 3/4"
 Imprint area 1/2" x 5 1/2"
 2 pt-200 receipts per book
 3 pt-200 receipts per book

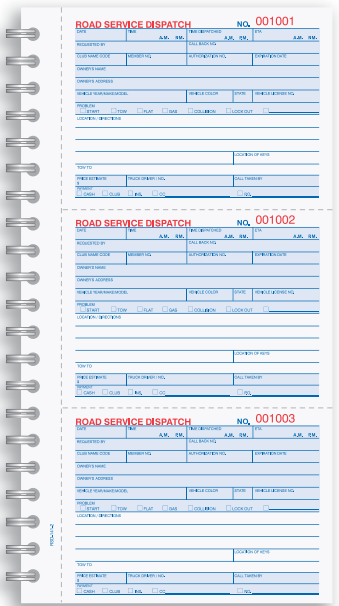

D RSD-141 - Wire Bound Book
 Road Service Dispatch Book, 5 1/4" x 11" overall
 Receipt size 5" x 3 3/4"
 150 sets per book

NOTE:



Colors correspond to sequence and number of parts selected in your order unless otherwise specified.



A AA-138 - Cash Receipt Book

Cat. No.	Pts.	Wt. per 5 Bks	Carbonless Lot Prices				
			5 Bks	10 Bks	15 Bks	25 Bks	50 Bks
138-3	3	6#	124.08	197.92	270.39	390.68	718.88
138-4	4	8#	236.09	344.00	461.00	674.18	1,257.53
Blank Lot Prices							
138-3	3	6#	115.50	184.33	251.50	363.76	668.35
138-4	4	8#	194.25	283.00	379.26	554.59	1,035.02

B NC-146 - Cash Receipt Book

Cat. No.	Pts.	Wt. per 5 Bks	Carbonless Lot Prices				
			5 Bks	10 Bks	15 Bks	25 Bks	50 Bks
146-2	2	5#	81.75	128.67	171.00	248.75	458.34
146-3	3	6#	108.92	171.17	228.00	332.50	610.83
Blank Lot Prices							
146-2	2	5#	75.92	119.50	158.75	232.09	425.84
146-3	3	6#	101.25	159.50	212.25	309.17	569.17

C NC-124 - Purchase Order Book

Cat. No.	Pts.	Wt. per 5 Bks	Carbonless Lot Prices				
			5 Bks	10 Bks	15 Bks	25 Bks	50 Bks
124-2	2	5#	81.75	128.67	171.00	248.75	458.34
124-3	3	7#	108.92	171.17	228.00	332.50	610.83
Blank Lot Prices							
124-2	2	5#	75.92	119.50	158.75	232.09	425.84
124-3	3	7#	101.25	159.50	212.25	309.17	569.17

D RSD-141 - Road Service Dispatch Book

Cat. No.	Pts.	Wt. per 5 Bks	Carbonless Lot Prices				
			5 Bks	10 Bks	15 Bks	25 Bks	50 Bks
141-2	2	5#	76.91	133.69	180.80	298.64	592.12

Not available imprinted. No choice of starting number.

UNALTERABLE CARBONLESS PAPER • NO CARBON IS REQUIRED

ODOMETER DISCLOSURE STATEMENT

FEDERAL LAW (AND STATE LAW, IF APPLICABLE) REQUIRES THAT YOU STATE THE MILEAGE UPON TRANSFER OF OWNERSHIP. FAILURE TO COMPLETE OR PROVIDING A FALSE STATEMENT MAY RESULT IN FINES AND/OR IMPRISONMENT.

I, _____ STATE THAT
(TRANSFEROR'S NAME • SELLER • PRINT)

THE ODOMETER NOW READS _____ (NO TENTHS) MILES AND TO THE BEST OF MY KNOWLEDGE THAT IT REFLECTS THE ACTUAL MILEAGE OF THE VEHICLE DESCRIBED BELOW, UNLESS ONE OF THE FOLLOWING STATEMENTS IS CHECKED.

(1) I HEREBY CERTIFY THAT TO THE BEST OF MY KNOWLEDGE THE ODOMETER READING REFLECTS THE AMOUNT OF MILEAGE IN EXCESS OF ITS MECHANICAL LIMITS.

(2) I HEREBY CERTIFY THAT THE ODOMETER READING IS NOT THE ACTUAL MILEAGE. **WARNING • ODOMETER DISCREPANCY.**

MAKE	MODEL	BODY TYPE
VEHICLE IDENTIFICATION NO.	YEAR	DEALER STOCK NO.

TRANSFEROR'S SIGNATURE (SELLER)
 (PRINTED NAME)
TRANSFEROR'S STREET ADDRESS (SELLER)
CITY STATE ZIP CODE
DATE OF STATEMENT

TRANSFEREE'S SIGNATURE (BUYER)
 (PRINTED NAME)
TRANSFEREE'S STREET ADDRESS
CITY STATE ZIP CODE

FORM REV. 10/03 ORIGINAL ODOMETER PRINTED IN U.S.A.

UNALTERABLE CARBONLESS PAPER • NO CARBON IS REQUIRED

ODOMETER DISCLOSURE STATEMENT

FEDERAL LAW (AND STATE LAW, IF APPLICABLE) REQUIRES THAT YOU STATE THE MILEAGE UPON TRANSFER OF OWNERSHIP. FAILURE TO COMPLETE OR PROVIDING A FALSE STATEMENT MAY RESULT IN FINES AND/OR IMPRISONMENT.

I, _____ STATE THAT
(TRANSFEROR'S NAME • SELLER • PRINT)

THE ODOMETER NOW READS _____ (NO TENTHS) MILES AND TO THE BEST OF MY KNOWLEDGE THAT IT REFLECTS THE ACTUAL MILEAGE OF THE VEHICLE DESCRIBED BELOW, UNLESS ONE OF THE FOLLOWING STATEMENTS IS CHECKED.

(1) I HEREBY CERTIFY THAT TO THE BEST OF MY KNOWLEDGE THE ODOMETER READING REFLECTS THE AMOUNT OF MILEAGE IN EXCESS OF ITS MECHANICAL LIMITS.

(2) I HEREBY CERTIFY THAT THE ODOMETER READING IS NOT THE ACTUAL MILEAGE. **WARNING • ODOMETER DISCREPANCY.**

MAKE	MODEL	BODY TYPE
VEHICLE IDENTIFICATION NO.	YEAR	DEALER STOCK NO.

TRANSFEROR'S SIGNATURE (SELLER)
 (PRINTED NAME)
TRANSFEROR'S STREET ADDRESS (SELLER)
CITY STATE ZIP CODE
DATE OF STATEMENT

TRANSFEREE'S SIGNATURE (BUYER)
 (PRINTED NAME)
TRANSFEREE'S STREET ADDRESS
CITY STATE ZIP CODE

FORM REV. 10/03 ORIGINAL ODOMETER PRINTED IN U.S.A.

G MCH-350, MCH-351, MCH-352, MCH-353
Mega Car Hanger, 8½" x 11"
Imprint area 8" x 9"

5 Day Shipping

4TH OF JULY BLOWOUT SALE

WAS \$ _____

SALE PRICE \$ _____

E OSCC-669 - Snap-A-Part
Odometer Disclosure Statement, 8½" x 11"

F OSCC-668 - Snap-A-Part
Odometer Disclosure Statement
5½" x 8½"

E OSCC-669 - Odometer Disclosure Statement

Cat. No.	Pts.	Wt. per 1000	Blank Carbonless Lot Prices				
			250	500	1000	2000	3000
OSCC-669-3	3	25#	82.21	128.91	226.56	422.40	621.45

Not available imprinted or numbered. (R)

F OSCC-668 - Odometer Disclosure Statement

Cat. No.	Pts.	Wt. per 1000	Blank Carbonless Lot Prices				
			250	500	1000	2000	3000
OSCC-668-3	3	13#	76.08	103.95	164.16	281.58	404.09

Not available imprinted or numbered. (R)

G MCH-350, MCH-351, MCH-352, MCH-353 - Mega Car Hanger - 13 PT CSU

Cat. No.	Color	Pts.	Wt. per 1000	Lot Prices					
				250	500	1000	2000	5000	10000
MCH-350-1	Red	1	42#	130.78	170.20	247.68	482.40	1,138.23	2,194.87
MCH-351-1	Yellow	1	42#	130.78	170.20	247.68	482.40	1,138.23	2,194.87
MCH-352-1	Pink	1	42#	130.78	170.20	247.68	482.40	1,138.23	2,194.87
MCH-353-1	Green	1	42#	130.78	170.20	247.68	482.40	1,138.23	2,194.87

No back printing available. Price includes black ink. Imprint charge for color other than black is \$31.24(R) per lot. (R)
See page 107 for available imprint colors.

H MCH-354 - 2 Color Mega Car Hanger - 10 PT CSU

Cat. No.	Color	Pts.	Wt. per 1000	Lot Prices					
				250	500	1000	2000	5000	10000
MCH-354-1	White	1	50#	130.78	170.20	247.68	482.40	1,138.23	2,194.87

No back printing available. See page 107 for available imprint colors. (R)

I CT-300 - 3 Section Claim Ticket

Cat. No.	Pts.	Wt. per 1000	Lot Prices				
			500	1000	2000	5000	10000
CT-300	1	15#	89.80	135.15	254.64	589.52	1,138.23

No back printing available. Imprint available in red, black, blue or green. (R)

J RSB-142 - Road Service Book

Cat. No.	Pts.	Wt. per 10 Bks	Carbonless Lot Prices				
			10 Bks	15 Bks	25 Bks	50 Bks	100 Bks
RSB-142-2	2	6#	139.00	187.25	286.68	514.33	994.71
RSB-142-3	3	7#	146.59	197.24	303.42	570.08	1,061.68

(R)

H MCH-354 - Your custom file printed
2 color on white
Mega Car Hanger, 8½" x 11"
Imprint area 8" x 9"

000
VEHICLE NUMBER

000
KEY TAG

000
YOUR COMPANY NAME
Address
CITY, STATE, ZIP CODE
Phone Number

YOUR COMPANY NAME
Address
CITY, STATE, ZIP CODE
Phone Number
Advertising Line
001001

ROAD SERVICE

DATE TIME CALL RECEIVED BY
ODOMETER OF VEHICLE
MILEAGE SERVICE TIME EXTRA PERSON
START START START
TOTAL TOTAL TOTAL
REPAIR

PROBLEM REPORTED SERVICE RENDERED SPECIAL EQUIPMENT INDICATE DAMAGED AREAS ON VEHICLE
 CLUTCH OIL FLUIDS BELT/CLUTCH BRAKES TIRE ROTATION WAXING/WASHING
 OIL CHANGE WAXING WAXING WAXING WAXING WAXING WAXING
 WAXING WAXING WAXING WAXING WAXING WAXING

APPROVED SIGNATURE AUTHORIZED SIGNATURE TOTAL

J RSB-142
Road Service Book, 5½" x 8½"
Imprint area 1" x 3"
50 sets per book

I CT-300
3 Section Claim Ticket, 4" x 8"
Imprint area: top section - 2" x 3½" (up to 1¾" number)
middle section - 1½" x 3" (up to ¾" number)
bottom section - 1½" x 3½" (up to ¾" number)

A BGS-685 - Snap-A-Part
Buyer's Guide Warranty, 8½" x 11"
Imprint area 1" x 3½"

BUYERS GUIDE

IMPORTANT: Spoken promises are difficult to enforce. Ask the dealer to put all promises in writing. Keep this form.

VEHICLE MAKE: _____ MODEL: _____ YEAR: _____

YOUR COMPANY NAME
Address: _____
CITY, STATE, ZIP CODE: _____
Phone Number: _____
Advertising Line: _____

WARRANTIES FOR THIS VEHICLE:

AS IS - NO WARRANTY

YOU WILL PAY ALL COSTS FOR ANY REPAIRS. THE DEALER ASSUMES NO RESPONSIBILITY FOR ANY REPAIRS REGARDLESS OF ANY ORAL STATEMENTS ABOUT THE VEHICLE.

WARRANTY

FULL LIMITED WARRANTY. The dealer will pay _____% of the labor and _____% of the parts for the covered systems that fail during the warranty period. Ask the dealer for a copy of the warranty document for a full explanation of warranty coverage, exclusions, and the dealer's repair obligations. Under state law, "implied warranties" may give you even more rights.

SYSTEMS COVERED: _____ DURATION: _____

BUYERS GUIDE

IMPORTANT: Spoken promises are difficult to enforce. Ask the dealer to put all promises in writing. Keep this form.

VEHICLE MAKE: _____ MODEL: _____ YEAR: _____

YOUR COMPANY NAME
Address: _____
CITY, STATE, ZIP CODE: _____
Phone Number: _____
Advertising Line: _____

WARRANTIES FOR THIS VEHICLE:

AS IS - NO WARRANTY

YOU WILL PAY ALL COSTS FOR ANY REPAIRS. THE DEALER ASSUMES NO RESPONSIBILITY FOR ANY REPAIRS REGARDLESS OF ANY ORAL STATEMENTS ABOUT THE VEHICLE.

WARRANTY

FULL LIMITED WARRANTY. The dealer will pay _____% of the labor and _____% of the parts for the covered systems that fail during the warranty period. Ask the dealer for a copy of the warranty document for a full explanation of warranty coverage, exclusions, and the dealer's repair obligations. Under state law, "implied warranties" may give you even more rights.

SYSTEMS COVERED: _____ DURATION: _____

BUYERS GUIDE

IMPORTANT: Spoken promises are difficult to enforce. Ask the dealer to put all promises in writing. Keep this form.

VEHICLE MAKE: _____ MODEL: _____ YEAR: _____

YOUR COMPANY NAME
Address: _____
CITY, STATE, ZIP CODE: _____
Phone Number: _____
Advertising Line: _____

WARRANTIES FOR THIS VEHICLE:

AS IS - NO WARRANTY

YOU WILL PAY ALL COSTS FOR ANY REPAIRS. THE DEALER ASSUMES NO RESPONSIBILITY FOR ANY REPAIRS REGARDLESS OF ANY ORAL STATEMENTS ABOUT THE VEHICLE.

WARRANTY

FULL LIMITED WARRANTY. The dealer will pay _____% of the labor and _____% of the parts for the covered systems that fail during the warranty period. Ask the dealer for a copy of the warranty document for a full explanation of warranty coverage, exclusions, and the dealer's repair obligations. Under state law, "implied warranties" may give you even more rights.

SYSTEMS COVERED: _____ DURATION: _____

BUYERS GUIDE

IMPORTANT: Spoken promises are difficult to enforce. Ask the dealer to put all promises in writing. Keep this form.

VEHICLE MAKE: _____ MODEL: _____ YEAR: _____

YOUR COMPANY NAME
Address: _____
CITY, STATE, ZIP CODE: _____
Phone Number: _____
Advertising Line: _____

WARRANTIES FOR THIS VEHICLE:

AS IS - NO WARRANTY

YOU WILL PAY ALL COSTS FOR ANY REPAIRS. THE DEALER ASSUMES NO RESPONSIBILITY FOR ANY REPAIRS REGARDLESS OF ANY ORAL STATEMENTS ABOUT THE VEHICLE.

WARRANTY

FULL LIMITED WARRANTY. The dealer will pay _____% of the labor and _____% of the parts for the covered systems that fail during the warranty period. Ask the dealer for a copy of the warranty document for a full explanation of warranty coverage, exclusions, and the dealer's repair obligations. Under state law, "implied warranties" may give you even more rights.

SYSTEMS COVERED: _____ DURATION: _____

B BGS-675 - Snap-A-Part
Buyer's Guide Warranty, 8½" x 11"
Imprint area 1" x 3½"

BUYERS GUIDE

IMPORTANT: Spoken promises are difficult to enforce. Ask the dealer to put all promises in writing. Keep this form.

VEHICLE MAKE: _____ MODEL: _____ YEAR: _____

YOUR COMPANY NAME
Address: _____
CITY, STATE, ZIP CODE: _____
Phone Number: _____
Advertising Line: _____

WARRANTIES FOR THIS VEHICLE:

IMPLIED WARRANTY

This means that the dealer does not make any specific promises to fix things that need repair when you buy the vehicle or after the time of sale. But, state law "implied warranties" may give you some rights to have the dealer take care of serious problems that were not apparent when you bought the vehicle.

WARRANTY

FULL LIMITED WARRANTY. The dealer will pay _____% of the labor and _____% of the parts for the covered systems that fail during the warranty period. Ask the dealer for a copy of the warranty document for a full explanation of warranty coverage, exclusions, and the dealer's repair obligations. Under state law, "implied warranties" may give you even more rights.

SYSTEMS COVERED: _____ DURATION: _____

BUYERS GUIDE

IMPORTANT: Spoken promises are difficult to enforce. Ask the dealer to put all promises in writing. Keep this form.

VEHICLE MAKE: _____ MODEL: _____ YEAR: _____

YOUR COMPANY NAME
Address: _____
CITY, STATE, ZIP CODE: _____
Phone Number: _____
Advertising Line: _____

WARRANTIES FOR THIS VEHICLE:

IMPLIED WARRANTIES ONLY

This means that the dealer does not make any specific promises to fix things that need repair when you buy the vehicle or after the time of sale. But, state law "implied warranties" may give you some rights to have the dealer take care of serious problems that were not apparent when you bought the vehicle.

WARRANTY

FULL LIMITED WARRANTY. The dealer will pay _____% of the labor and _____% of the parts for the covered systems that fail during the warranty period. Ask the dealer for a copy of the warranty document for a full explanation of warranty coverage, exclusions, and the dealer's repair obligations. Under state law, "implied warranties" may give you even more rights.

SYSTEMS COVERED: _____ DURATION: _____

B BGS-775 - Snap-A-Part
Buyer's Guide Warranty, w/Mirror Hanger, 8½" x 11"
Imprint area 1" x 3½"

A BGS-685, 885 - Buyer's Guide Warranty

Cat. No.	BGS-	Pts.	Wt. per 1000	Carbonless Lot Prices			
				250	500	1000	2000
685-2	2	16#	102.80	156.36	270.14	495.61	727.64
885-3†	3	16#	117.26	183.82	324.12	604.08	889.36

Available numbered in red by request. (R)
†Mirror hanger.

B BGS-675, 775 - Buyer's Guide Warranty

Cat. No.	BGS-	Pts.	Wt. per 1000	Carbonless Lot Prices			
				250	500	1000	2000
675-2	2	16#	102.80	156.36	270.14	495.61	727.64
775-3†	3	16#	117.26	183.82	324.12	604.08	889.36

Available numbered in red by request. (R)
†Mirror hanger.

C BGS-565, 575 - Spanish Buyer's Guide Warranty

Cat. No.	BGS-	Pts.	Wt. per 1000	Carbonless Lot Prices			
				250	500	1000	2000
565-2 As Is	2	14#	102.80	156.36	270.14	495.61	727.64
575-2 Implied	2	14#	102.80	156.36	270.14	495.61	727.64

Available numbered in red by request. (R)

D BGS-555 - Buyer's Guide Warranty

Cat. No.	BGS-	Pts.	Wt. per 1000	Carbonless Lot Prices			
				250	500	1000	2000
555-2	2	14#	102.80	156.36	270.14	495.61	727.64

Available numbered in red by request. (R)

NOTE:



A BGS-885 - Snap-A-Part
Buyer's Guide Warranty w/Mirror Hanger, 8½" x 11"
Imprint area 1" x 3½"

GUÍA DEL COMPRADOR

IMPORTANTE: Las promesas verbales son difíciles de hacer cumplir. Solicite al vendedor que ponga todas las promesas por escrito. Conserve este formulario.

VEHICLE MAKE: _____ MODEL: _____ YEAR: _____

GARANTÍAS PARA ESTE VEHICULO:

COMO ESTÁ - SIN GARANTÍA

LISTED PAGARÁ TODOS LOS GASTOS DE CUALQUIER REPARACIÓN QUE SEA NECESARIA. El vendedor no asume ninguna responsabilidad por cualquier reparación, sean cuales sean las declaraciones verbales que haya hecho acerca del vehículo.

GARANTÍA

COMPLETA. LIMITADA. El vendedor pagará el _____% de la mano de obra y el _____% de los repuestos de los sistemas cubiertos que dejen de funcionar durante el periodo de garantía. Pida al vendedor una copia del documento de garantía donde se especifique detalladamente la cobertura de la garantía, exclusiones y las obligaciones que tiene el vendedor de realizar reparaciones. Conforme a la ley estatal, las "garantías implícitas" pueden darle a usted incluso más derechos.

SYSTEMAS CUBIERTOS POR LA GARANTIA: _____ DURACION: _____

CONTRATO DE SERVICIO. Este vehículo tiene disponible un contrato de servicio a un precio adicional. Pida los detalles acerca de cobertura, deducible, precio y exclusiones. Si adquiere un contrato de servicio dentro de los 90 días del momento de la venta, las "garantías implícitas" de acuerdo a la ley estatal pueden consistirle derechos adicionales.

INSPECCION PREVIEN A LA COMPRA: PREGUNTE AL VENDEDOR SI PUEDE LLEVAR UN MECANICO PARA QUE INSPECCIONE EL AUTOMOVIL, O LLEVAR EL AUTOMOVIL PARA QUE ESTE LO INSPECCIONE EN SU TALLER.

VEASE EL DORSE DE ESTE FORMULARIO donde se proporciona informacion adicional importante, incluyendo una lista de algunos de los principales defectos que pueden ocurrir en vehículos usados.

BUYERS GUIDE

IMPORTANT: Spoken promises are difficult to enforce. Ask the dealer to put all promises in writing. Keep this form.

VEHICLE MAKE: _____ MODEL: _____ YEAR: _____

YOUR COMPANY NAME
Address: _____
CITY, STATE, ZIP CODE: _____
Phone Number: _____
Advertising Line: _____

WARRANTIES FOR THIS VEHICLE:

AS IS - NO WARRANTY

YOU WILL PAY ALL COSTS FOR ANY REPAIRS. The dealer assumes no responsibility for any repairs regardless of any oral statements about the vehicle.

WARRANTY

FULL LIMITED WARRANTY. The dealer will pay _____% of the labor and _____% of the parts for the covered systems that fail during the warranty period. Ask the dealer for a copy of the warranty document for a full explanation of warranty coverage, exclusions, and the dealer's repair obligations. Under state law, "implied warranties" may give you even more rights.

SYSTEMS COVERED: _____ DURATION: _____

BUYERS GUIDE

IMPORTANT: Spoken promises are difficult to enforce. Ask the dealer to put all promises in writing. Keep this form.

VEHICLE MAKE: _____ MODEL: _____ YEAR: _____

YOUR COMPANY NAME
Address: _____
CITY, STATE, ZIP CODE: _____
Phone Number: _____
Advertising Line: _____

WARRANTIES FOR THIS VEHICLE:

AS IS - NO WARRANTY

YOU WILL PAY ALL COSTS FOR ANY REPAIRS. THE DEALER ASSUMES NO RESPONSIBILITY FOR ANY REPAIRS REGARDLESS OF ANY ORAL STATEMENTS ABOUT THE VEHICLE.

WARRANTY

FULL LIMITED WARRANTY. The dealer will pay _____% of the labor and _____% of the parts for the covered systems that fail during the warranty period. Ask the dealer for a copy of the warranty document for a full explanation of warranty coverage, exclusions, and the dealer's repair obligations. Under state law, "implied warranties" may give you even more rights.

SYSTEMS COVERED: _____ DURATION: _____

BUYERS GUIDE

IMPORTANT: Spoken promises are difficult to enforce. Ask the dealer to put all promises in writing. Keep this form.

VEHICLE MAKE: _____ MODEL: _____ YEAR: _____

YOUR COMPANY NAME
Address: _____
CITY, STATE, ZIP CODE: _____
Phone Number: _____
Advertising Line: _____

WARRANTIES FOR THIS VEHICLE:

AS IS - NO WARRANTY

YOU WILL PAY ALL COSTS FOR ANY REPAIRS. THE DEALER ASSUMES NO RESPONSIBILITY FOR ANY REPAIRS REGARDLESS OF ANY ORAL STATEMENTS ABOUT THE VEHICLE.

WARRANTY

FULL LIMITED WARRANTY. The dealer will pay _____% of the labor and _____% of the parts for the covered systems that fail during the warranty period. Ask the dealer for a copy of the warranty document for a full explanation of warranty coverage, exclusions, and the dealer's repair obligations. Under state law, "implied warranties" may give you even more rights.

SYSTEMS COVERED: _____ DURATION: _____

C BGS-565 - Snap-A-Part
Spanish Buyer's Guide Warranty
As is - no warranty, 7½" x 12"

BGS-575 - Snap-A-Part
Implied warranties only, 7½" x 11½"
Imprint area 1" x 3½"

D BGS-555 - Snap-A-Part
Buyer's Guide Warranty, 7½" x 11½"
Imprint area 1" x 3½"



E Floor Mats, Car Design

Size	Imprint
20" x 14"	3¼" x 13"
19" x 17"	3¼" x 12"
22" x 17"	3¼" x 15"

E Floor Mats, Car Design

Cat. No.	FM-	Size	Color	Wt. per 1000	Lot Prices				
					250	500	1000	2000	3000
9944		20" x 14"	Red	44#	150.64	175.29	210.86	314.65	420.94
9945		19" x 17"	Red	48#	153.66	178.93	215.02	321.10	429.36
9946		22" x 17"	Red	52#	156.78	182.36	219.39	327.55	437.58
9934		20" x 14"	Blue	44#	150.64	175.29	210.86	314.65	420.94
9935		19" x 17"	Blue	48#	153.66	178.93	215.02	321.10	429.36
9936		22" x 17"	Blue	52#	156.78	182.36	219.39	327.55	437.58

Imprint available in black ink only. For blank floor mats, deduct 30%. (R)

F Floor Mats, Footprints Design

Cat. No.	FM-	Size	Color	Wt. per 1000	Lot Prices				
					250	500	1000	2000	3000
9941		20" x 14"	Red	44#	150.64	175.29	210.86	314.65	420.94
9942		19" x 17"	Red	48#	153.66	178.93	215.02	321.10	429.36
9931		20" x 14"	Blue	44#	150.64	175.29	210.86	314.65	420.94
9932		19" x 17"	Blue	48#	153.66	178.93	215.02	321.10	429.36
9933		22" x 17"	Blue	52#	156.78	182.36	219.39	327.55	437.58

Imprint available in black ink only. For blank floor mats, deduct 30%. (R)

G Truck Floor Mats, Footprints Design

Cat. No.	FM-	Size	Color	Wt. per 1000	Lot Prices				
					250	500	1000	2000	3000
9923		17" x 22"	Blue	52#	156.78	182.36	219.39	327.55	437.58
9924		17" x 22"	Red	52#	156.78	182.36	219.39	327.55	437.58

Imprint available in black ink only. For blank floor mats, deduct 30%. (R)

H Truck Floor Mats, Truck Design

Cat. No.	FM-	Size	Color	Wt. per 1000	Lot Prices				
					250	500	1000	2000	3000
9921		17" x 22"	Blue	52#	156.78	182.36	219.39	327.55	437.58
9922		17" x 22"	Red	52#	156.78	182.36	219.39	327.55	437.58

Imprint available in black ink only. For blank floor mats, deduct 30%. (R)

NOTE:



Includes your company's name, address and phone number in one of four colors! For blank forms, subtract 30% unless otherwise listed.



Colors correspond to sequence and number of parts selected in your order unless otherwise specified.



Choose a six-digit number for your imprinted form, or seven-digit for all register forms at no extra charge! Otherwise, we will start with 001001 or 0001001. Four, five and custom seven-digit numbering available at an additional charge. See page 142 for pricing.

Blank forms will be sequentially numbered unless specified otherwise.



All Floor Mats printed on 24# bond.



F Floor Mats, Footprints Design

Size	Imprint
20" x 14"	3" x 6"
19" x 17"	3" x 6"
22" x 17"	4" x 7¼"

G Truck Mats, Footprints Design

Size	Imprint
17" x 22"	3¼" x 15"

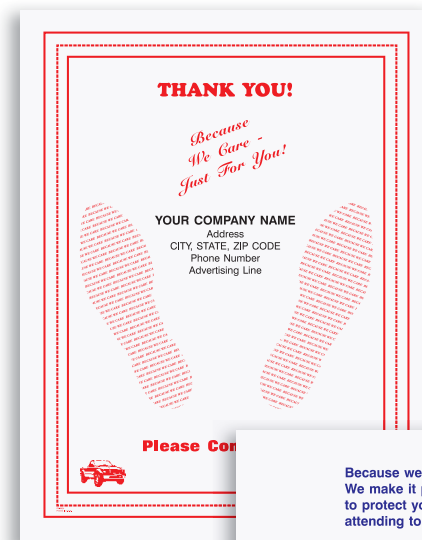

H Truck Mats, Truck Design

Size	Imprint
17" x 22"	3¼" x 15"

Marine Repair

A MS-249 - Register Form

Marine Service Agreement, 5 1/2" x 8 1/2"
Imprint area 1" x 5"

YOUR COMPANY NAME
Address
CITY, STATE, ZIP CODE
Phone Number
Advertising Line

0001001

MARINE PURCHASE AGREEMENT
001001

SUBJECT TO THE TERMS AND CONDITIONS STATED ON BOTH SIDES OF THIS AGREEMENT, SELLER AGREES TO SELL AND BUYER AGREES TO BUY THE FOLLOWING DESCRIBED PROPERTY.

QTY.	PART NO.	DESCRIPTION	PRICED	AMOUNT

OPTIONAL EQUIPMENT/ACCESSORIES

DESCRIPTION	QTY.	UNIT PRICE	AMOUNT

TOTAL PURCHASE ABOVE \$

SALES TAX (if applicable) \$

DEL. AND/OR LAUNCHING FEE \$

NET TOTAL \$

LESS BALANCE DUE ON ABOVE \$

NET AMOUNT DUE \$

SALES TAX (if not included above) \$

TITLE - REGISTRATION - OFFICE FEES \$

CASH SALE PRICE \$

LESS TOTAL PAYMENTS \$

UNPAID BALANCE OF CASH SALE PRICE \$

TOTAL TRADE-IN ALLOWANCE \$

TRANSACTION TO BE PAID BY: DEALER CUSTOMER

WE RECOMMEND THE FOLLOWING REPAIRS:

TOTAL LABOR \$

TOTAL PARTS \$

TOTAL \$

REVISED ESTIMATE

NOTE: A SERVICE FEE OF \$ PER DAY WILL BE CHARGED IF SERVICE IS NOT COMPLETED BY DATE OF NOTIFICATION OF COMPLETION.

Imprint Your Message Here!

B MPACC-736 - Snap-A-Part

Marine Purchase Agreement, 8 1/2" x 14"
Imprint area 3 1/4" x 4"
Message imprint area 1 1/8" x 3 1/2"

YOUR COMPANY NAME
Address
CITY, STATE, ZIP CODE
Phone Number
Advertising Line

001001

MARINE PURCHASE AGREEMENT

SUBJECT TO THE TERMS AND CONDITIONS STATED ON BOTH SIDES OF THIS AGREEMENT, SELLER AGREES TO SELL AND BUYER AGREES TO BUY THE FOLLOWING DESCRIBED PROPERTY.

QTY.	PART NO.	DESCRIPTION	PRICED	AMOUNT

OPTIONAL EQUIPMENT/ACCESSORIES

DESCRIPTION	QTY.	UNIT PRICE	AMOUNT

TOTAL PURCHASE ABOVE \$

SALES TAX (if applicable) \$

DEL. AND/OR LAUNCHING FEE \$

NET TOTAL \$

LESS BALANCE DUE ON ABOVE \$

NET AMOUNT DUE \$

SALES TAX (if not included above) \$

TITLE - REGISTRATION - OFFICE FEES \$

CASH SALE PRICE \$

LESS TOTAL PAYMENTS \$

UNPAID BALANCE OF CASH SALE PRICE \$

TOTAL TRADE-IN ALLOWANCE \$

TRANSACTION TO BE PAID BY: DEALER CUSTOMER

WE RECOMMEND THE FOLLOWING REPAIRS:

TOTAL LABOR \$

TOTAL PARTS \$

TOTAL \$

REVISED ESTIMATE

NOTE: A SERVICE FEE OF \$ PER DAY WILL BE CHARGED IF SERVICE IS NOT COMPLETED BY DATE OF NOTIFICATION OF COMPLETION.

D SEROCC-638, SERO-635 - Snap-A-Part

Small Engine/Motorcycle Repair, 11" x 8 1/2"
Imprint area 1" x 4"

YOUR COMPANY NAME
Address
CITY, STATE, ZIP CODE
Phone Number
Advertising Line

001001

MARINE PURCHASE AGREEMENT

SUBJECT TO THE TERMS AND CONDITIONS STATED ON BOTH SIDES OF THIS AGREEMENT, SELLER AGREES TO SELL AND BUYER AGREES TO BUY THE FOLLOWING DESCRIBED PROPERTY.

QTY.	PART NO.	DESCRIPTION	AMOUNT

OPTIONAL EQUIPMENT/ACCESSORIES

DESCRIPTION	QTY.	UNIT PRICE	AMOUNT

TOTAL PURCHASE ABOVE \$

SALES TAX (if applicable) \$

DEL. AND/OR LAUNCHING FEE \$

NET TOTAL \$

LESS BALANCE DUE ON ABOVE \$

NET AMOUNT DUE \$

SALES TAX (if not included above) \$

TITLE - REGISTRATION - OFFICE FEES \$

CASH SALE PRICE \$

LESS TOTAL PAYMENTS \$

UNPAID BALANCE OF CASH SALE PRICE \$

TOTAL TRADE-IN ALLOWANCE \$

TRANSACTION TO BE PAID BY: DEALER CUSTOMER

WE RECOMMEND THE FOLLOWING REPAIRS:

TOTAL LABOR \$

TOTAL PARTS \$

TOTAL \$

REVISED ESTIMATE

NOTE: A SERVICE FEE OF \$ PER DAY WILL BE CHARGED IF SERVICE IS NOT COMPLETED BY DATE OF NOTIFICATION OF COMPLETION.

C MROCC-634, MRO-636 - Snap-A-Part

Marine Repair Order, 11" x 8 1/2"
Imprint area: Top - 1 1/4" x 3 1/2", Side - 1" x 2 1/2"

A MS-249 - Marine Service Agreement

Cat. No.	MS-	Pts.	Wt. per 1000	Carbonless Lot Prices			
				250	500	1000	2000
249-2	2	8#	74.62	97.50	140.56	228.54	315.17
249-3	3	12#	84.40	116.84	178.83	302.80	432.17

7 digit numbering only. (R)

B MPACC-736 - Marine Purchase Agreement

Cat. No.	MPACC-	Pts.	Wt. per 1000	Carbonless Lot Prices			
				250	500	1000	2000
736-3	3	41#	218.04	296.97	444.86	848.38	1,233.70

(R)

C MROCC-634, MRO-636 - Marine Repair Order

Cat. No.	MROCC-	Pts.	Wt. per 1000	Carbonless Lot Prices			
				250	500	1000	2000
634-3	3	35#	135.88	208.88	321.31	610.53	867.72

MRO-

Cat. No.	MRO-	Pts.	Wt. per 1000	Carbon Lot Prices			
				250	500	1000	2000
636-3	3	41#	110.08	170.40	297.18	549.28	805.22

Last part is manila tag. (R)

D SEROCC-638, SERO-635 - Small Engine/Motorcycle Repair

Cat. No.	SEROCC-	Pts.	Wt. per 1000	Carbonless Lot Prices			
				250	500	1000	2000
638-3	3	35#	118.20	191.93	340.55	652.86	966.11

SERO-

Cat. No.	SERO-	Pts.	Wt. per 1000	Carbon Lot Prices			
				250	500	1000	2000
635-3	3	41#	110.08	170.40	297.18	549.28	805.22

Last part is manila tag. (R)

NOTE:

1 Day Blank
3 Day Imprint
Shipping

HVAC SERVICE ORDER INVOICE

YOUR COMPANY NAME
Address
CITY, STATE, ZIP CODE
Phone Number
Advertising Line

001001

TEL NO. DATE TO BE PERFORMED BY (NAME) (ADDRESS) (CITY) (STATE) (ZIP CODE)

STREET CITY STATE ZIP CODE

PHONE NO. FAX NO.

WORK TO BE PERFORMED

INSPECTION CHECKLIST

DESCRIPTION OF WORK PERFORMED

TOTAL MATERIALS

TOTAL LABOR

RECOMMENDATIONS

WARRANTY

INSPECTION CHARGES

TOTAL

BEST SELLER

YOUR COMPANY NAME
Address
CITY, STATE, ZIP CODE
Phone Number
Advertising Line

001001

DATE ORDERED

DATE SCHEDULED

NAME

MODEL

ADDRESS

CITY STATE ZIP

PHONE

FAX/CELL

TELEPHONE

DESCRIPTION OF SERVICE WORK

AMOUNT

TOTAL PARTS

INSPECTION CHECKLIST

INSPECTION CHARGES

TOTAL

B HAC-681 - Snap-A-Part
Home Heating & Air Conditioning, 11" x 8 1/2"
Imprint area 1" x 3 1/2"

A HVAC-683 - Snap-A-Part
Home Heating, Ventilation & Air Conditioning, 11" x 8 1/2"
Imprint area 1" x 3 1/2"

A HVAC-683 - Home Heating, Ventilation & Air Conditioning

Cat. No.	Pts.	Wt. per 1000	Carbonless Lot Prices				
			250	500	1000	2000	3000
HVAC-683-3	3	35#	122.92	199.61	354.17	678.97	1,004.75

Last part is manila tag. (R)

B HAC-681 - Home Heating & Air Conditioning

Cat. No.	Pts.	Wt. per 1000	Carbonless Lot Prices				
			250	500	1000	2000	3000
HAC-681-3	3	35#	122.92	199.61	354.17	678.97	1,004.75

Last part is manila tag. (R)

C HAC-680 - Auto Heating & Air Conditioning

Cat. No.	Pts.	Wt. per 1000	Carbonless Lot Prices				
			250	500	1000	2000	3000
HAC-680-3	3	35#	122.92	199.61	354.17	678.97	1,004.75

Last part is manila tag. (R)

D HAC-684 - Auto Heating & Air Conditioning

Cat. No.	Pts.	Wt. per 1000	Carbonless Lot Prices				
			250	500	1000	2000	3000
HAC-684-3	3	35#	122.92	199.61	354.17	678.97	1,004.75

Last part is manila tag. (R)

YOUR COMPANY NAME
Address
CITY, STATE, ZIP CODE
Phone Number
Advertising Line

001001

DATE ORDERED

DATE SCHEDULED

NAME

MODEL

ADDRESS

CITY STATE ZIP

PHONE

FAX/CELL

TELEPHONE

DESCRIPTION OF SERVICE WORK

AMOUNT

TOTAL PARTS

INSPECTION CHECKLIST

INSPECTION CHARGES

TOTAL

C HAC-680 - Snap-A-Part
Auto Heating & Air Conditioning, 11" x 8 1/2"
Imprint area 1" x 3 1/2"

YOUR COMPANY NAME
Address
CITY, STATE, ZIP CODE
Phone Number
Advertising Line

001001

DATE ORDERED

DATE SCHEDULED

NAME

MODEL

ADDRESS

CITY STATE ZIP

PHONE

FAX/CELL

TELEPHONE

DESCRIPTION OF SERVICE WORK

AMOUNT

TOTAL PARTS

INSPECTION CHECKLIST

INSPECTION CHARGES

TOTAL

Imprint Your Message Here

D HAC-684 - Snap-A-Part
Auto Heating & Air Conditioning, 11" x 8 1/2"
Imprint area 1" x 3 1/2"
Message imprint area 1 1/2" x 3 3/4"

NOTE:

Company Imprint
Includes your company's name, address and phone number in one of four colors! For blank forms, subtract 30% unless otherwise listed.

Starting Number
Choose a six-digit number for your imprinted form, or seven-digit for all register forms at no extra charge! Otherwise, we will start with 001001 or 0001001. Four, five and custom seven-digit numbering available at an additional charge. See page 142 for pricing.

Multi-part Color Sequence
Colors correspond to sequence and number of parts selected in your order unless otherwise specified.

Blank forms will be sequentially numbered unless specified otherwise.

PC 882
PRINTED IN U.S.A.

Pest Control Service Agreement

YOUR COMPANY NAME
Address
CITY, STATE, ZIP CODE
Phone Number
Advertising Line

001001

Customer Name: _____

Street: _____

City, State and Zip: _____

Phone: _____

Date Service Began: _____

Types of Pests to be Controlled:

Annual Agreement Charge \$ _____

Initial Service Charge \$ _____

Monthly/Quarterly Payments \$ _____

PC 882 - Snap-A-Part
Pest Control Service Agreement, 8½" x 11"
Imprint area 1¼" x 6"

PC 880
PRINTED IN U.S.A.

YOUR COMPANY NAME

Address
CITY, STATE, ZIP CODE
Phone Number
Advertising Line

Order No. _____ Date _____

Account No. _____ Invoice No. _____

Order Type: REGULAR RESIDENTIAL MOBILE
 HOME COMMERCIAL OUTDOOR

Service Type: INSPECTION TREATMENT

Frequency: ANNUALLY 6 MONTHLY 3 MONTHLY WEEKLY

Target Pests:

Chemicals Used:

Sub-TOTAL _____

TAX _____

TOTAL _____

ACCOUNT BALANCE _____

Payment Method: CASH AMOUNT PAID CHECK # _____

Balance Due _____

PC 880 - Snap-A-Part
Pest Control Service Order/Invoice
5½" x 8½"
Imprint area ¾" x 5"

PC 881
PRINTED IN U.S.A.

YOUR COMPANY NAME

Address
CITY, STATE, ZIP CODE
Phone Number

Order No. _____ Date _____

Account No. _____ Invoice No. _____

Service Type: INSPECTION TREATMENT

Frequency: ANNUALLY 6 MONTHLY 3 MONTHLY WEEKLY

Target Pests:

Chemicals Used:

Sub-TOTAL _____

TAX _____

TOTAL _____

ACCOUNT BALANCE _____

Payment Method: CASH AMOUNT PAID CHECK # _____

Balance Due _____

PC 881 - Wrap Around Book
Pest Control Service Report Book
3½" x 6¼"
Imprint area ¾" x 3"
50 sets per book.

A **PC 882 - Snap-A-Part**
Pest Control Service Agreement, 8½" x 11"
Imprint area 1¼" x 6"

A **PC 882 - Pest Control Service Agreement**

Cat. No.	PCC-	Pts.	Wt. per 1000	Carbonless Lot Prices			
				250	500	1000	2000
882-2	2	16#	97.83	143.04	241.47	435.72	630.84

Envelopes available on page 100. (9906) (R)

B **PC 880 - Pest Control Service Order/Invoice**

Cat. No.	PCC-	Pts.	Wt. per 1000	Carbonless Lot Prices			
				250	500	1000	2000
880-3	3	13#	93.50	135.04	224.16	398.52	580.77

Envelopes available on page 101. (9919) (R)

C **PC 881 - Pest Control Service Report Book**

Cat. No.	PC-	Pts.	Wt. per 10 Bks	Carbonless Lot Prices			
				10 Bks	15 Bks	25 Bks	50 Bks
881-3	3	4#		129.41	167.05	250.77	446.65

Envelopes available on page 101. (9919) (R)

D **PC 879 - Pest Control Inspection**

Cat. No.	PCIC-	Pts.	Wt. per 1000	Carbonless Lot Prices			
				250	500	1000	2000
879-2	2	9#	80.53	110.05	175.06	304.85	431.94

Numbered by request only. (R)

PC 879
PRINTED IN U.S.A.

PEST CONTROL INSPECTION

YOUR COMPANY NAME
Address
CITY, STATE, ZIP CODE
Phone Number

Date: _____ Technician: _____ Account # _____ City Location: _____

Residential: _____ Commercial: _____ Industrial: _____ Spraying: _____

****NOTE: A thorough inspection was performed on your home/building today. Please take time to read this report. It contains important information about the condition of your property. If you have any questions, please give me a call. I'll be happy to explain.

Target Pests:

Chemicals Used:

Types of Solution:

Name: _____ Address: _____ City: _____ State: _____ Zip: _____

Total amount due / paid \$ _____

****NOTE: Conditions conducive for Wood Destroying Organisms observed as follows: Your home/building is in need of _____

Subsequent Treatments: _____

Wood Destroying Organisms: _____

Wood Boring Beetles: _____

Periodic Pest Inspections: _____

PC 879 - Snap-A-Part
Pest Control Inspection, 8½" x 5½"
Imprint area ¾" x 3"

D **PC 879 - Snap-A-Part**
Pest Control Inspection, 8½" x 5½"
Imprint area ¾" x 3"

NOTE:



Includes your company's name, address and phone number in one of four colors! For blank forms, subtract 30% unless otherwise listed.



Colors correspond to sequence and number of parts selected in your order unless otherwise specified.



Choose a six-digit number for your imprinted form, or seven-digit for all register forms at no extra charge! Otherwise, we will start with 001001 or 0001001. Four, five and custom seven-digit numbering available at an additional charge. See page 142 for pricing.

Blank forms will be sequentially numbered unless specified otherwise.

Advertise with Business Card Magnets from Page 106.

LPCC 792
Printed in U.S.A.

YOUR COMPANY NAME
Address
CITY, STATE, ZIP CODE
Phone Number
Advertising Line

Page No. _____ of _____ Pages

LANDSCAPING PROPOSAL

CONTRACTOR LICENSE NO. _____ JOB PHONE NO. _____
JOB NAME/NO. _____
JOB LOCATION _____
LANDSCAPE ARCHITECT _____ DATE OF PLANS _____
APPROXIMATE STARTING DATE _____ APPROXIMATE COMPLETION DATE _____

TO: _____
PHONE: _____ DATE: _____

We hereby submit specifications and estimates for landscaping as follows:

Put Your Disclaimer Here at No Extra Charge!

We Propose hereby to furnish material and labor - complete in accordance with above specifications, for the sum of: _____ dollars (\$ _____).

Payment to be made as follows: _____

Acceptance of Proposal: The above prices, specifications and conditions are satisfactory and are hereby accepted. You are authorized to do the work as specified. Payment will be made as outlined above.

Signature _____ Date _____ Signature _____ Date _____

A LPCC-792 - Snap-A-Part
Landscaping Proposal, 8½" x 11"
Imprint area 1" x 4"
Disclaimer imprint area 3½" x 2½"

LPCC 794
Printed in U.S.A.

YOUR COMPANY NAME
Address
CITY, STATE, ZIP CODE
Phone Number
Advertising Line

001001

LANDSCAPING Work Order/Invoice

DATE OF ORDER _____ WORK TEL. _____
ORDER TAKEN BY _____ WORK TEL. _____
CUSTOMER ORDER NO. _____ SEASONAL CONTRACT REPEAT
START/END DATE _____ ONE TIME JOB
JOB NAME/NO. _____
JOB LOCATION _____
WORK SITE _____ JOB TEL. _____

TERMS: _____

CHECKMARKS DENOTE: WORK COMPLETED WORK TO BE DONE

PREPARATION	PLANTING	MULCHING	EDGERS/BORDERS	PRUNING/THINNING	FERTILIZING
DESIGN/PLANNING	SHRUBS <input type="checkbox"/>	<input type="checkbox"/>	<input type="checkbox"/>	<input type="checkbox"/>	<input type="checkbox"/>
GRADING	HEDGES <input type="checkbox"/>	<input type="checkbox"/>	<input type="checkbox"/>	<input type="checkbox"/>	<input type="checkbox"/>
SOIL PREPARATION	TREES <input type="checkbox"/>	<input type="checkbox"/>	<input type="checkbox"/>	<input type="checkbox"/>	<input type="checkbox"/>
LAWN INSTALLATION	FLOWERING PLANTS <input type="checkbox"/>	<input type="checkbox"/>	<input type="checkbox"/>	<input type="checkbox"/>	<input type="checkbox"/>
SOIL	DESCRIPTION OF WORK:				
SEEDING					
LAWN MAINTENANCE					
SOAKING					
FERTILIZING					
TRIM					
PAVING					
DEMOLITION					
STRUCTURING					
INSPECT AND WEED CONTROL					
HYDROSEEDING					
TOTAL LABOR					
CITY: _____ MATERIAL _____ UNIT _____ AMOUNT _____					
MASONRY & STONEMAN					
STONE WALL _____					
STAIRS _____					
RETAINING _____					
WALKWAY _____					
FENCE _____					
WATER FEATURES					
METAL FOUNTAIN _____					
INSTALL WATER FOUNTAIN _____					
INSTALL SPRINKLER SYSTEM _____					
ROBBERIES AND CHANGES _____					
MISCELLANEOUS					
SPRING - FULL CLEANUP _____					
PODOLING _____					
POST HOLE DRILLING _____					
STUMP REMOVAL & CHIPPING _____					
MISC. TREE WORK _____					
DEBRIS REMOVAL _____					
TOTAL					

C LWOCC-794 - Snap-A-Part
Landscaping Work Order, 8½" x 11"
Imprint area 1" x 4"
Includes snow removal.



B FH-9977, 9979, 9980
Forms Holder
Top or Side Opening

A LPCC-792 - Landscaping Proposal

Cat. No.	Pts.	Wt. per 1000	Carbonless Lot Prices				
			250	500	1000	2000	3000
792-3	3	25#	122.60	193.23	339.89	633.55	933.37

Numbered by request only. (R)
Envelopes available on page 100. (9906, 9907)

B FH-9977, 9979, 9980 - Forms Holder

Cat. No.	Wt. each	For Forms Up To	Opens	Price Each
				Each
9977	2#	5½" x 9½"	Top	36.94
9979	3#	8½" x 12"	Top	56.62
9980	3#	8½" x 12"	Side	57.60

(R)

C LWOCC-794 - Landscaping Work Order

Cat. No.	Pts.	Wt. per 1000	Carbonless Lot Prices				
			250	500	1000	2000	3000
794-3	3	35#	122.92	199.50	354.17	678.97	1,004.75

Last part is manila tag. (R)
Envelopes available on page 100. (9906, 9907)

NOTE:



Includes your company's name, address and phone number in one of four colors! For blank forms, subtract 30% unless otherwise listed.



Colors correspond to sequence and number of parts selected in your order unless otherwise specified.



Choose a six-digit number for your imprinted form, or seven-digit for all register forms at no extra charge! Otherwise, we will start with 001001 or 0001001. Four, five and custom seven-digit numbering available at an additional charge. See page 142 for pricing.

Blank forms will be sequentially numbered unless specified otherwise.

- See page 96 for Document Jackets designed for your business.
- Phantoms are enhanced for display purpose.

D LWO-893
Landscape Work Order/Invoice, 8½" x 11"
Imprint area 1" x 4"

E LE-791
Landscape Estimate, 8½" x 11"
Includes snow removal.

D LWO-893 - Landscape Work Order/Invoice

Cat. No.	Wt.	Lot Prices					
LWO-	Pts.	per 1000	250	500	1000	2000	3000
893-1	1	11#	79.88	102.91	133.20	229.25	260.83

Envelopes available on page 100. (9906, 9909, 9907) (R)

E LE-791 - Landscape Estimate

Cat. No.	Wt.	Blank Lot Prices					
LE-	Pts.	per 1000	250	500	1000	2000	3000
791-1	1	19#	67.44	99.13	154.83	247.09	341.84

Not available imprinted or numbered. Printed on manila stock. (R)
Envelopes available on page 100. (9906)

F LMCC-793 - Lawn Maintenance Invoice

Cat. No.	Wt.	Carbonless Lot Prices					
LMCC-	Pts.	per 1000	250	500	1000	2000	3000
793-3	3	13#	93.50	135.04	224.16	398.52	580.77

Envelopes available on pages 100-101. (9919, 9913, 9915) (R)

F LMCC-793 - Snap-A-Part
Lawn Maintenance Invoice, 5½" x 8½"
Imprint area 1" x 3"
Includes snow removal.

NOTE:

1 Day Blank Shipping **3 Day Imprint Shipping**

See page 79 for easy to use color-coded Collection Forms. See page 99 to combine with a Business Reply Envelope in a matching color.

Custom cards and envelopes up to 4-color, full bleed.

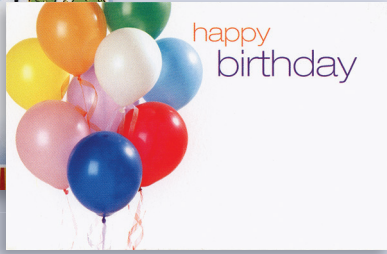

A **FGC-625**
Florist Gift Card, 3½" x 2¼"
Imprint area 3½" x 2¼"

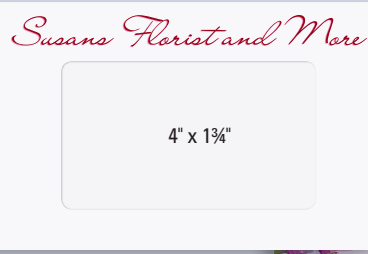

B **ENV-9868, 9869**
Gift Card Envelopes, 3" x 4½"
Imprint area 3" x 4½"

YOUR COMPANY NAME
Address
CITY, STATE, ZIP CODE
Phone Number
Advertising Line

Wedding Flowers
001001

ITEM	DESCRIPTION	QUANTITY	UNIT PRICE	AMOUNT
WEDDING FLOWERS	WEDDING FLOWERS	1	202.53	202.53
RECEIPT	RECEIPT	1	146.18	146.18
SALES TAX	SALES TAX		14.62	14.62
TOTAL	TOTAL			363.33

0001001

C-F are Marble Only.

YOUR COMPANY NAME
Address
CITY, STATE, ZIP CODE
Phone Number
Advertising Line

0001001

C **WFCC-648 - Snap-A-Part**
Wedding Flower Order Form, 8½" x 13¼"
Imprint area 1½" x 4"

D **GSF-221 - Register Form**
Florist Sales, 5½" x 8½"
Imprint area 1" x 5"

E **GSF-239 - Register Form**
Florist Sales, 4" x 6½"
Imprint area 1" x 3½"

F **GSFCC-639 - Snap-A-Part**
Florist Sales, 5½" x 8½"
Imprint area 1" x 5"

YOUR COMPANY NAME
Address
CITY, STATE, ZIP CODE
Phone Number
Advertising Line

DATE	TIME	ORDERED BY	DELIVERED BY

QUANTITY	DESCRIPTION	AMOUNT

0001001

G **GSF-214 - Register Form**
Florist Sales, 5½" x 8½"
Imprint area 1" x 5"

H **GSF-229 - Register Form**
Florist Sales, 4" x 6½"
Imprint area 1" x 3½"

I **GSFCC-649 - Snap-A-Part**
Florist Sales, 5½" x 8½"
Imprint area 1" x 5"

A **FGC-625 - Florist Gift Card - Custom**

Cat. No.	Size	Wt. per 1000	Imprinted Lot Prices			
			100	250	500	1000
625-1	3½" x 2¼"	3#	21.66	43.34	65.00	86.66

100# Endurance Velvet Cover (R)

B **ENV-9868, 9869 - Gift Card Envelopes**

Cat. No.	Size	Wt. per 1000	Imprinted Lot Prices			
			100	250	500	1000
9868	3" x 4½" Regular	4#	34.66	69.34	104.00	138.66
9869	3" x 4½" Window	4#	39.00	78.00	112.67	147.34

Deduct 30% for blank envelopes. (R)

C **WFCC-648 - Wedding Flower Order Form**

Cat. No.	Pts.	Wt. per 1000	Carbonless Lot Prices			
			250	500	1000	2000
648-2	2	15#	202.53	274.13	437.78	832.02

Layout grids for ceremony/reception on back. (R)

D **GSF-221 - Florist Sales**

Cat. No.	Pts.	Wt. per 1000	Carbonless Lot Prices			
			250	500	1000	2000
221-2	2	8#	77.60	101.40	146.18	237.68
221-3	3	12#	87.78	121.52	185.98	314.91

7 digit numbering only. (R)

E **GSF-239 - Florist Sales**

Cat. No.	Pts.	Wt. per 1000	Carbonless Lot Prices			
			250	500	1000	2000
239-2	2	5#	74.46	96.32	130.60	200.70

7 digit numbering only. (R)

F **GSFCC-639 - Florist Sales**

Cat. No.	Pts.	Wt. per 1000	Carbonless Lot Prices			
			250	500	1000	2000
639-3	3	13#	98.05	141.53	235.52	418.63

(R)

G **GSF-214 - Florist Sales**

Cat. No.	Pts.	Wt. per 1000	Carbonless Lot Prices			
			250	500	1000	2000
214-2	2	8#	77.60	101.40	146.18	237.68
214-3	3	12#	87.78	121.52	185.98	314.91

7 digit numbering only. (R)

H **GSF-229 - Florist Sales**

Cat. No.	Pts.	Wt. per 1000	Carbonless Lot Prices			
			250	500	1000	2000
229-2	2	5#	74.46	96.31	130.60	200.69
229-3	3	7#	84.42	108.97	155.26	250.23

7 digit numbering only. (R)

I **GSFCC-649 - Florist Sales**

Cat. No.	Pts.	Wt. per 1000	Carbonless Lot Prices			
			250	500	1000	2000
649-3	3	13#	98.05	141.53	235.52	418.63

(R)

A GJ-219 - Register Form
Gift/Jewelry, 5 1/2" x 8 1/2"
Imprint area 1" x 5"

A GJ-219 - Gift/Jewelry

Cat. No.	Pts.	Wt. per 1000	Carbonless Lot Prices				
			250	500	1000	2000	3000
GJ-219-2	2	8#	77.60	101.40	146.18	237.68	327.67
GJ-219-3	3	12#	87.78	121.52	185.98	314.91	452.70

7 digit numbering only. (R)

B JRE-9947 - Jewelry Repair Envelope

Cat. No.	Pts.	Wt. per 1000	Carbonless Lot Prices				
			250	500	1000	2000	3000
JRE-9947	3	24#	181.76	259.64	387.38	758.69	1,058.72

(R)

C JRE-9948 - Jewelry Repair Envelope/Claim Check

Cat. No.	Pts.	Wt. per 1000	Carbonless Imprinted Lot Prices				
			100	250	500	1000	2000
JRE-9948	3	18#	92.21	141.74	218.32	343.03	644.47

Carbonless Blank Lot Prices

9948	3	18#	68.09	104.32	161.75	255.42	479.09
------	---	-----	-------	--------	--------	--------	--------

(R)

D GJ-212 - Gift/Jewelry

Cat. No.	Pts.	Wt. per 1000	Carbonless Lot Prices				
			250	500	1000	2000	3000
GJ-212-2	2	5#	69.71	85.28	115.57	177.76	239.63
GJ-212-3	3	6#	76.74	99.13	141.20	227.84	314.58

7 digit numbering only. (R)

E GJ-241 - Gift/Jewelry

Cat. No.	Pts.	Wt. per 1000	Carbonless Lot Prices				
			250	500	1000	2000	3000
GJ-241-2	2	5#	74.47	96.32	130.60	200.70	269.80
GJ-241-3	3	7#	84.42	108.97	155.26	250.23	345.84

7 digit numbering only. (R)

B JRE-9947
Jewelry Repair Envelope, 5 1/2" x 9 1/4"
Imprint area 7/8" x 4 1/2"
Metal clasp provides easy access to envelope.

3-Parts!

- Part 3 is the jewelry envelope.
- Part 2 is the customer claim form.
- Part 1 is for your records.

C JRE-9948

Jewelry Repair Envelope/Claim Check
4 1/4" x 7 1/4"
Imprint area 1" x 3 1/2"
Envelope has pressure sensitive tape

D GJ-212 - Register Form
Gift/Jewelry, 4" x 6"
Imprint area 1" x 3 1/2"

E GJ-241 - Register Form
Gift/Jewelry, 4" x 6 1/2"
Imprint area 1" x 3 1/2"

NOTE:

Company Imprint

Includes your company's name, address and phone number in one of four colors! For blank forms, subtract 30% unless otherwise listed.

Starting Number

Choose a six-digit number for your imprinted form, or seven-digit for all register forms at no extra charge! Otherwise, we will start with 001001 or 0001001. Four, five and custom seven-digit numbering available at an additional charge. See page 142 for pricing.

Multi-part Color Sequence

Colors correspond to sequence and number of parts selected in your order unless otherwise specified.

1 Day Blank Shipping

3 Day Imprint



Backer

A 4651 - Snap-A-Part
Bar Guest Check, 4 1/4" x 6 1/2"
Imprint area 5/8" x 3 1/2"



B 4928 - Snap-A-Part
Guest Check, 4 1/4" x 9"
Imprint area 5/8" x 3 1/2", Bilingual



End of Part-1

C 4929 - Snap-A-Part
Guest Check, 4 1/4" x 9"
Imprint area 5/8" x 3 1/2", Bilingual

A 4651 - Bar Guest Check

Cat. No.	Pts.	Wt. per 2500	Imprinted Lot Prices				
			2500	5000	10000	15000	20000
4651	1	13#	235.19	425.56	854.63	1,213.28	1,582.65
			Blank Lot Prices				
4651	1	13#	108.32	198.31	382.62	567.14	746.90

All checks will be imprinted in brown ink unless otherwise specified. (R)

B 4928 - Guest Check, Bilingual

Cat. No.	Pts.	Wt. per 2500	Imprinted Lot Prices				
			2500	5000	10000	15000	20000
4928	1	18#	253.80	463.20	882.86	1,313.22	1,733.64
			Blank Lot Prices				
4928	1	18#	128.66	238.98	467.85	700.71	917.68

All checks will be imprinted in brown ink unless otherwise specified. Bilingual. (R)

C 4929 - Guest Check, Bilingual

Cat. No.	Pts.	Wt. per 2500	Imprinted Carbonless Lot Prices				
			2500	5000	10000	15000	20000
4929	2	24#	288.41	535.23	1,035.79	1,544.15	2,043.85
			Blank Carbonless Lot Prices				
4929	2	24#	131.68	256.50	506.35	749.93	987.12

All checks will be imprinted in brown ink unless otherwise specified. Bilingual. (R)

D 4851 - Bar Guest Check

Cat. No.	Pts.	Wt. per 2500	Imprinted Lot Prices				
			2500	5000	10000	15000	20000
4851	1	19#	253.80	463.20	882.86	1,313.22	1,733.64
			Blank Lot Prices				
4851	1	19#	128.66	238.98	467.85	700.71	917.68

All checks will be imprinted in brown ink unless otherwise specified. (R)

NOTE:



Choose a six-digit number for your imprinted form, or seven-digit for all register forms at no extra charge! Otherwise, we will start with 001001 or 0001001. Four, five and custom seven-digit numbering available at an additional charge. See page 142 for pricing.

Blank forms will be sequentially numbered unless specified otherwise.

Special!

We will pad your Guest Checks in sets of 50 with a firm glue binding and backer for just \$4.31(R) per 1000.

! If your guests are Bilingual, the 4928 or 4929 may work best for you.



Backer

D 4851 - Snap-A-Part
Bar Guest Check, 4 1/4" x 9"
Imprint area 5/8" x 3 1/2"



Guest Check

SERVER TABLE NO. GUESTS DATE 047533

1	
2	
3	
4	
5	
6	
7	
8	
9	
10	
11	
12	
13	
14	
15	

TRANSFER TO FRONT TOTAL

May you think of your visit as a pleasant one, rewarding as with your return.

Receipt is for your convenience

FOOD BEVERAGE SUB TOTAL TAX TOTAL

THANK YOU

GUEST RECEIPT 047533

DATE AMOUNT

Beverages

1	
2	
3	

TRANSFER TO FRONT TOTAL

May you think of your visit as a pleasant one, rewarding as with your return.

Receipt is for your convenience

FOOD BEVERAGE SUB TOTAL TAX TOTAL

THANK YOU

GUEST RECEIPT 047533

DATE AMOUNT

End of Part-1

Backer

A 412 - Snap-A-Part
Guest Check, 4 1/4" x 9"

KITCHEN CHECK

Chef Table Guests Server 001001

APPT-SOUP-SAL-ENTREE-VEG-POT-DESSERT-BEV

GUEST CHECK™

Chef Table Guests Server 001001

APPT-SOUP-SAL-ENTREE-VEG-POT-DESSERT-BEV

Tax Total

Thank You - Please Come Again

Part 2

Guest Check

TABLE NO. NO. PERSONS SERVER NO. 001001

Tax Total

Thank You!

B 4246 - Snap-A-Part
Guest Check, 3 5/8" x 6 1/8"

C 814 - Snap-A-Part
Guest Check Pad, 3 5/8" x 6"
100 checks per pad

A 412 - Guest Check

Cat. No.	Pts.	Wt. per 2000	Impact Paper Lot Prices				
			2000	4000	8000	20000	48000
412	2	22#	120.44	234.76	463.41	1,129.14	2,675.28

No choice of starting number. (R)
Not available imprinted.

B 4246 - Guest Check

Cat. No.	Pts.	Wt. per 2500	Carbonless Lot Prices				
			2500	5000	10000	15000	20000
4246	2	13#	123.03	238.98	457.46	649.99	817.53

No choice of starting number. (R)
Not available imprinted.

C 814 - Guest Check Pad

Cat. No.	Pts.	Wt. per 40 Pads	Lot Prices		
			40 Pads	200 Pads	400 Pads
814	1	8#	37.80	175.60	331.35

No choice of starting number. (R)
Not available imprinted.

D 700 - Guest Check

Cat. No.	Pts.	Wt. per 2000	Carbonless Lot Prices				
			2000	4000	8000	20000	48000
700	2	22#	155.91	280.95	509.06	1,171.10	2,719.95

No choice of starting number. (R)
Not available imprinted.

NOTE:



Choose a six-digit number for your imprinted form, or seven-digit for all register forms at no extra charge! Otherwise, we will start with 001001 or 0001001. Four, five and custom seven-digit numbering available at an additional charge. See page 142 for pricing.

Blank forms will be sequentially numbered unless specified otherwise.

Special!

We will pad your Guest Checks in sets of 50 with a firm glue binding and backer for just \$4.31(R) per 1000.



Beverages

1	
2	
3	

TRANSFER TO FRONT TOTAL

May you think of your visit as a pleasant one, rewarding as with your return.

Receipt is for your convenience

FOOD BEVERAGE SUB TOTAL TAX TOTAL

THANK YOU

GUEST RECEIPT 8804091

DATE AMOUNT

End of Part-1

Backer

D 700 - Snap-A-Part
Guest Check, 4 1/4" x 9"

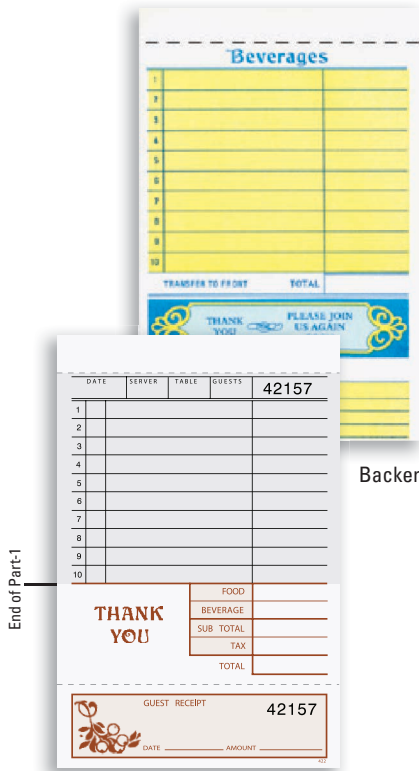

Backer



Backer



Backer

E 422 - Snap-A-Part
Guest Check, 4 1/4" x 6 1/2"

F 4918 - Snap-A-Part
Guest Check, 4 1/4" x 9"
Imprint area 5/8" x 3 1/2"

G 4912, 4913 - Snap-A-Part
Guest Check, 4 1/4" x 9"
Imprint area 5/8" x 3 1/2"

E 422 - Guest Check

Cat. No.	Pts.	Wt. per 2000	Impact Paper Lot Prices			
			2000	4000	8000	20000
422	2	16#	118.60	201.12	361.42	824.67
			2000	4000	8000	20000
			118.60	201.12	361.42	824.67

No choice of starting number.
Not available imprinted. (R)

F 4918 - Guest Check

Cat. No.	Pts.	Wt. per 2500	Imprinted Lot Prices			
			2500	5000	10000	20000
4918	1	18#	253.80	463.20	882.86	1,313.22
			Blank Lot Prices			
4918	1	18#	128.66	238.98	467.85	917.68

All checks will be imprinted in brown ink unless otherwise specified. (R)

G 4912, 4913 - Guest Check

Cat. No.	Pts.	Wt. per 2500	Imprinted Carbonless Lot Prices			
			2500	5000	10000	20000
4912	2	24#	329.94	612.02	1,184.73	2,337.61
			per 2000	2000	6000	10000
4912	2	24#	150.72	293.49	579.25	1,129.14
			per 2000	2000	6000	10000
4913	3	27#	336.11	951.54	1,546.31	3,063.58
			Blank Carbonless Lot Prices			
4913	3	27#	247.63	721.91	1,187.76	2,332.31

All checks will be imprinted in brown ink unless otherwise specified. (R)

H 434 - Guest Check

Cat. No.	Pts.	Wt. per 2000	Carbonless Lot Prices			
			2000	4000	8000	20000
434	2	22#	120.44	234.76	463.41	1,129.14

No choice of starting number.
Not available imprinted. (R)

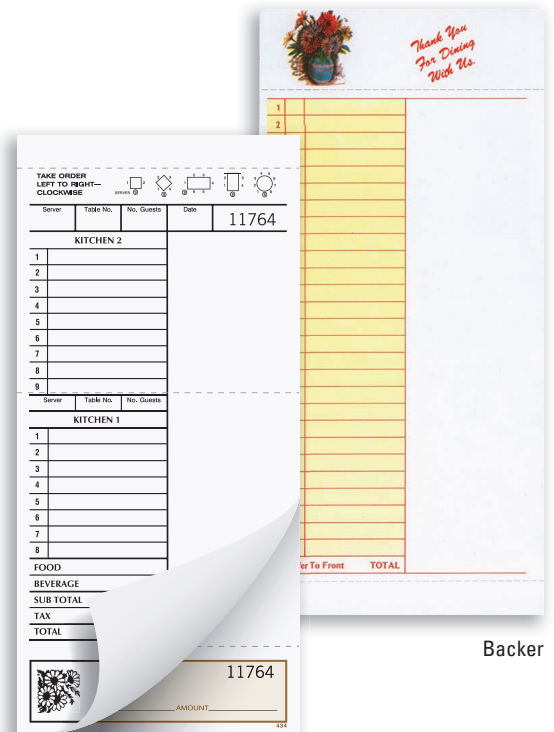

Backer

H 434 - Snap-A-Part
Guest Check, 4 1/4" x 9"



-  4901 Italian Food
-  4902 Steaks
-  4905 Mexican Food



B 4611, 4622 - Snap-A-Part
Guest Check, 4¼" x 6½"
Imprint area ¾" x 3½"

A 4901, 4902, 4905 - Snap-A-Part
Guest Check, 4½" x 9"
Imprint area ¾" x 3½"

A 4901, 4902, 4905 - Guest Check

Cat. No.	Pts.	Wt. per 2500	Imprinted Carbonless Lot Prices				
			2500	5000	10000	15000	20000
4901	2	23#	329.94	612.02	1,184.73	1,766.20	2,337.61
4902	2	23#	329.94	612.02	1,184.73	1,766.20	2,337.61
4905	2	23#	329.94	612.02	1,184.73	1,766.20	2,337.61
Blank Carbonless Lot Prices							
4901	2	23#	150.72	293.49	579.25	857.87	1,129.14
4902	2	23#	150.72	293.49	579.25	857.87	1,129.14
4905	2	23#	150.72	293.49	579.25	857.87	1,129.14

All checks will be imprinted in brown ink unless otherwise specified. (R)

B 4611, 4622 - Guest Check

Cat. No.	Pts.	Wt. per 2500	Imprinted Carbonless Lot Prices				
			2500	5000	10000	15000	20000
4611	1	13#	235.19	425.56	822.18	1,213.28	1,582.65
4622	2	17#	301.50	555.35	1,071.60	1,591.95	2,108.20
Blank Carbonless Lot Prices							
4611	1	13#	108.32	198.31	382.62	567.14	746.90
4622	2	17#	177.44	336.54	660.70	979.98	1,291.92

All checks will be imprinted in brown ink unless otherwise specified. (R)

C NS-247 - Guest Check

Cat. No.	Pts.	Wt. per 2500	Imprinted Carbonless Lot Prices			
			2500	5000	10000	15000
NS-247	2	25#	329.94	612.02	1,184.73	1,766.20
Blank Carbonless Lot Prices						
NS-247	2	25#	150.72	293.49	579.25	857.87

All checks will be imprinted in brown ink unless otherwise specified. (R)

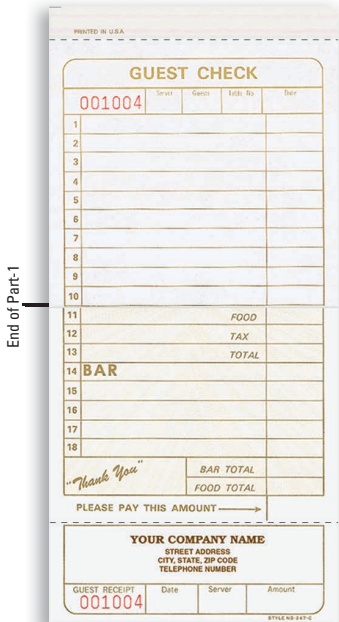

C NS-247 - Snap-A-Part
Guest Check, 4¼" x 9"
Imprint area ¾" x 3½"

NOTE:



Choose a six-digit number for your imprinted form, or seven-digit for all register forms at no extra charge! Otherwise, we will start with 001001 or 0001001. Four, five and custom seven-digit numbering available at an additional charge. See page 142 for pricing.

Blank forms will be sequentially numbered unless specified otherwise.

Special!

We will pad your Guest Checks in sets of 50 with a firm glue binding and backer for just \$4.31(R) per 1000.





D 312 - Snap-A-Part
Guest Check, 4¼" x 9"

E 204 - Snap-A-Part
Guest Check, 4¼" x 9"

F BR-598 - Snap-A-Part
Guest Check, 5" x 9½"
Imprint area ¾" x 3½"

D 312 - Guest Check

Cat. No.	Pts.	Wt. per 2000	Impact Paper Lot Prices				
			2000	4000	8000	20000	48000
312	2	22#	120.44	234.76	463.41	1,129.14	2,675.28

No choice of starting number.
Not available imprinted. (R)

E 204 - Guest Check

Cat. No.	Pts.	Wt. per 2000	Carbonless Lot Prices				
			2000	4000	8000	20000	48000
204	3	22#	205.45	380.89	723.86	1,747.38	4,104.94

No choice of starting number.
Not available imprinted. (R)

F BR-598 - Guest Check

Cat. No.	Pts.	Wt. per 2500	Imprinted Impact Paper Lot Prices				
			2500	5000	10000	15000	20000
598-1	1	21#	253.04	454.65	836.24	1,219.56	1,579.84
598-2	2	28#	353.86	684.79	1,333.44	1,845.12	2,398.60

Blank Impact Paper Lot Prices							
Cat. No.	Pts.	Wt. per 2500	2500	5000	10000	15000	20000
598-1	1	21#	147.48	264.29	510.57	739.00	949.59
598-2	2	28#	251.20	481.69	950.13	1,405.16	1,846.78

All checks will be imprinted in brown ink unless otherwise specified. (R)

G 202 - Guest Check

Cat. No.	Pts.	Wt. per 2000	Lot Prices				
			2000	4000	8000	20000	48000
202	1	12#	95.34	165.00	276.73	604.56	1,365.79

No choice of starting number.
Not available imprinted. (R)



G 202 - Snap-A-Part
Guest Check, 4¼" x 8½"

GUEST REGISTRATION

NAME _____ ROOM NO. _____

STREET _____ CHECK-OUT DATE _____

CITY _____ STATE AND ZIP _____ ARRIVAL DATE / TIME _____

(AREA CODE) PHONE NO. _____ COMPANY REPRESENTING _____ ROOM RATE / TAX _____

CAR LICENSE _____ STATE _____ MAKE AND COLOR _____ YEAR _____ RECEIVED BY _____

NO. IN PARTY _____ SIGNATURE _____

PAYMENT WILL BE MADE BY: CREDIT CARD CASH CHECK

DAYS OCCUPIED		ROOM TOTAL
SUN		TAX
MON		
TUE		
WED		TOTAL
THURS		AMT. PAID
FRI		AMT. DUE
SAT		

NOTICE TO GUESTS
This property is privately owned, and management reserves the right to refuse service to anyone. We will not be responsible for accidents or injury to guests or for loss of money, jewelry or valuables of any kind.

CHECK-OUT TIME: 11 AM

YOUR COMPANY NAME
Address
CITY, STATE, ZIP CODE
Phone Number

001001

GRCC-694-2
Printed in U.S.A.

- A GRCC-694 - Snap-A-Part**
Hotel Guest Registration Form, 5¼" x 4¼"
Imprint area 1" x 4"
Imprint includes your 'check out' time choice.



- C 4805 - Key Card Holder**
One Curved Pocket, 2¾" x 4½" (closed)
Imprint area 2¼" x 1"

Card Holder, Inside Layout

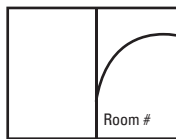

4805

HOOK OVER MIRROR PLACE ON CAR DASH

01001

LOCATION _____

LICENSE NO. _____ MAKE OF CAR _____

SPECIAL NOTES:

VALET COPY

YOUR COMPANY NAME
Address
CITY, STATE, ZIP CODE
Phone Number
Advertising Line

NO CAR RELEASED WITHOUT THIS CLAIM CHECK
No responsibility for auto accessories or articles left in car is assumed. No liability is assumed for fire, theft or damage while in the custody of the valet service.
Thank You! Please Come Again. GUEST RECEIPT

01001

Item #226800

- B VC-800 - Valet Parking Tag**
3½" x 7"
Imprint area ¾" x 2¾"

A GRCC-694 - Hotel Guest Registration Form

Cat. No.	Pts.	Wt. per 1000	Carbonless Lot Prices				
			250	500	1000	2000	3000
694-2	2	6#	62.79	104.54	174.30	313.72	444.59

Last part is white tag. (R)

B VC-800 - Valet Parking Tag

Cat. No.	Pts.	Wt. per 10 Pkgs	Imprinted Lot Prices				
			1 Pkgs	2 Pkgs	5 Pkgs	10 Pkgs	20 Pkgs
800-1	1	5#	69.28	70.36	118.06	164.13	313.07
Blank Lot Prices							
800-1	1	5#	43.21	49.27	87.99	125.63	245.25

No choice of starting number. (R)
100 per package.

C 4805 - Key Card Holder - One Curved Pocket

Cat. No.	per 1000	Wt.	Imprinted Lot Prices				
			100	250	500	1000	2500
4805	12#		87.99	138.72	218.54	345.84	771.99
Blank Lot Prices							
4805	12#		64.73	107.89	179.71	299.77	674.22

Not available numbered. (R)

NOTE:



Includes your company's name, address and phone number in one of four colors! For blank forms, subtract 30% unless otherwise listed.



Colors correspond to sequence and number of parts selected in your order unless otherwise specified.



Choose a six-digit number for your imprinted form, or seven-digit for all register forms at no extra charge! Otherwise, we will start with 001001 or 0001001. Four, five and custom seven-digit numbering available at an additional charge. See page 142 for pricing.

Blank forms will be sequentially numbered unless specified otherwise.



A PDE-9949
Pill/Drug Envelope, 2¼" x 3½"
Gummed flap
24# White

A PDE-9949 - Pill/Drug Envelope		Blank Lot Prices			
Cat. No.	Wt. per 1000	250	500	1000	2000
9949	4#	56.19	89.50	127.90	242.98

Not available imprinted. (R)

B COPA-185 - Co-Pay Medical Receipt Book		Carbonless Imprinted Lot Prices					
Cat. No.	Pts.	Wt. per 5 Bks	5 Bks	10 Bks	15 Bks	25 Bks	50 Bks
185-2	2	4#	130.06	189.44	240.06	340.22	600.23
Carbonless Blank Lot Prices							
185-2	2	4#	91.12	132.77	168.03	238.44	420.26

(R)

C MRB-109 - Medical Receipt Book		Carbonless Imprinted Lot Prices					
Cat. No.	Pts.	Wt. per 5 Bks	5 Bks	10 Bks	15 Bks	25 Bks	50 Bks
109-3	3	6#	217.97	352.36	489.31	715.53	1,367.63

(R)

NOTE:



Includes your company's name, address and phone number in one of four colors! For blank forms, subtract 30% unless otherwise listed.



Choose a six-digit number for your imprinted form, or seven-digit for all register forms at no extra charge! Otherwise, we will start with 001001 or 0001001. Four, five and custom seven-digit numbering available at an additional charge. See page 142 for pricing.

Blank forms will be sequentially numbered unless specified otherwise.



Colors correspond to sequence and number of parts selected in your order unless otherwise specified.



B COPA-185 - Wire Bound Book
Co-Pay Medical Receipt Book, 6½" x 11" overall
Receipt size 5½" x 2¾"
Imprint area ¾" x 1¾"
200 receipts per book

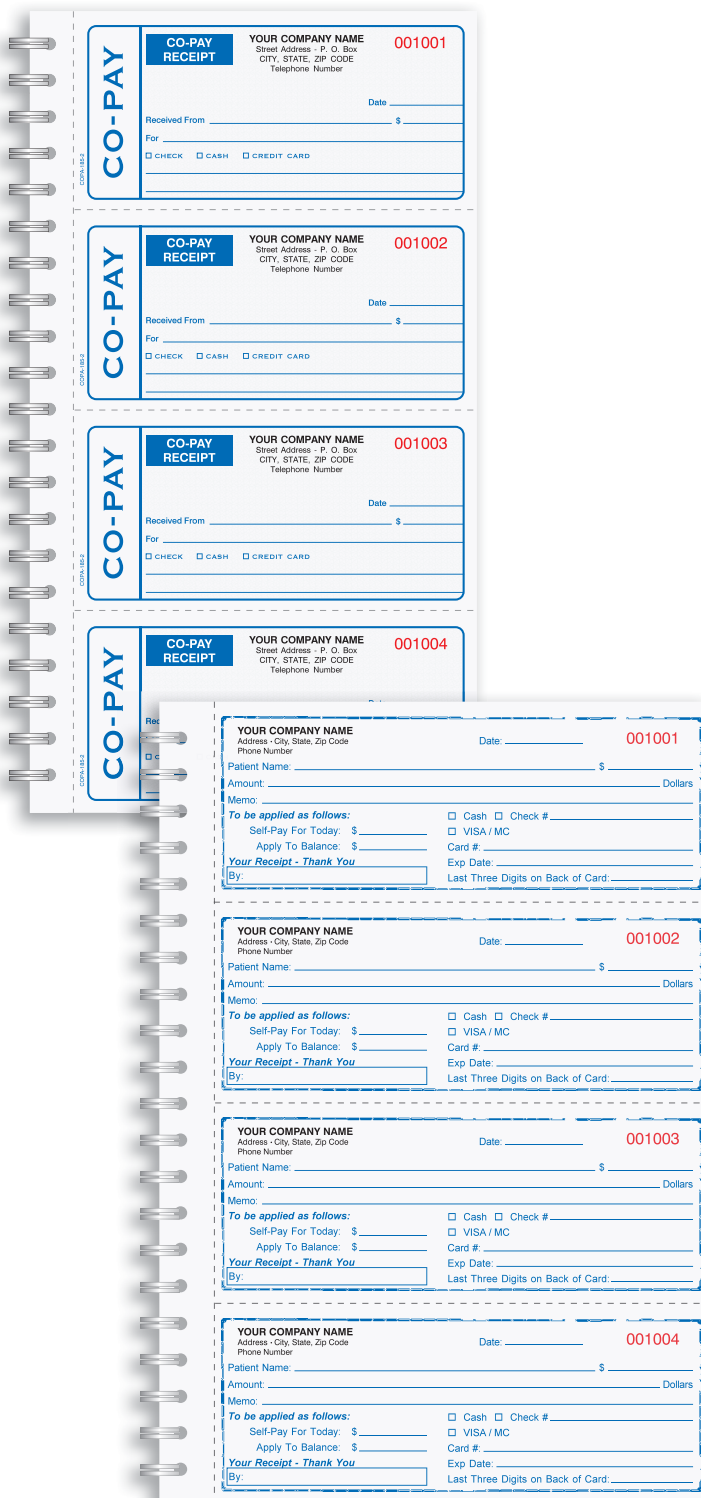

C MRB-109 - Wire Bound Book
Medical Receipt Book, 7½" x 11" overall
Receipt size 6¾" x 2¾"
Imprint area ⅞" x 2½"
200 receipts per book

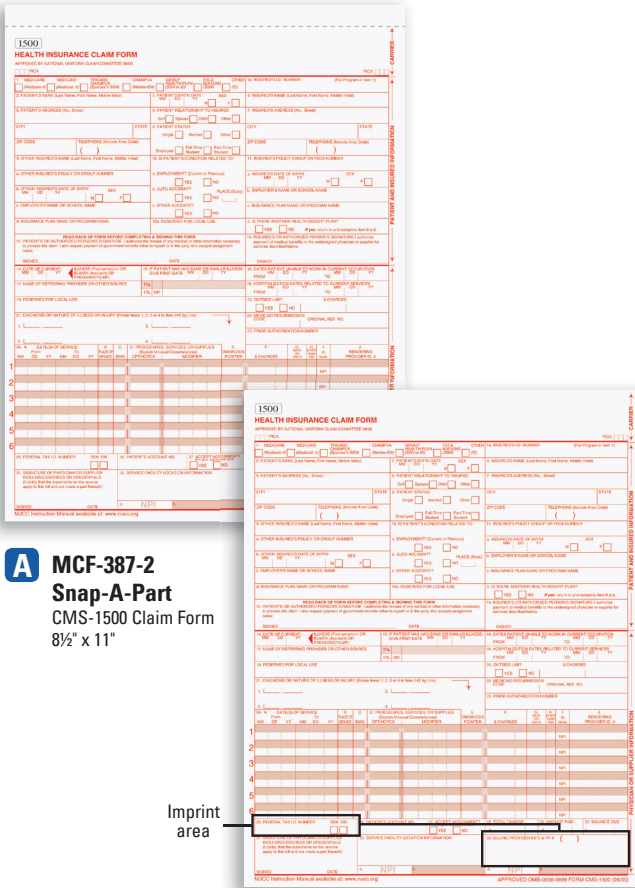

A **MCF-387-2 Snap-A-Part**
CMS-1500 Claim Form
8½" x 11"

Imprint area

B **MCF-387-1 - Laser**
CMS-1500 Claim Form, 8½" x 11"

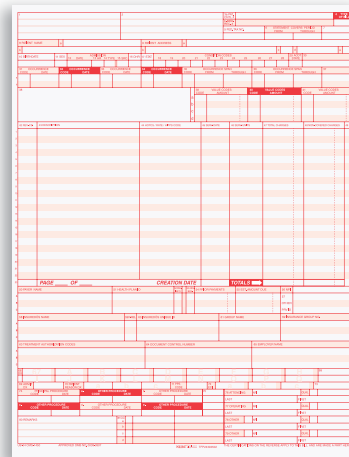

C **MCF-389-1 - Laser**
UB-04, CMS-1450 Claim Form, 8½" x 11"

A **MCF-387-2 - CMS-1500 Claim Form - Snap-A-Part**

Cat. No.	MCF-	Pts.	Wt. per 1000	Carbonless Imprinted Lot Prices			
				250	500	1000	2000
387-2	2	18#	73.39	97.29	120.00	228.70	284.51
Blank Lot Prices							
387-2	2	18#	49.05	70.03	85.82	168.68	210.21

Not available numbered. (R)
Envelopes available on page 39.

B **MCF-387-1 - CMS-1500 Claim Form - Laser**

Cat. No.	MCF-	Pts.	Wt. per 1000	Imprinted Lot Prices			
				250	500	1000	2000
387-1	1	12#	45.37	57.16	69.71	126.49	155.84
Blank Lot Prices							
387-1	1	12#	21.04	30.12	35.32	66.46	81.39

Not available numbered. (R)
Envelopes available on page 39.

C **MCF-389 - UB-04, CMS-1450 Claim Form**

Cat. No.	MCF-	Pts.	Wt. per 1000	Blank Lot Prices			
				250	500	1000	2000
389-1	1	12#	19.74	28.39	33.26	62.68	76.74

Not available imprinted or numbered. (R)
Envelopes available on page 39.

D **ENV-9961 - Large Claim Form Envelope**

Cat. No.	ENV-	Wt. per 500	Imprinted Lot Prices			
			100	200	500	1000
9961		12#	59.97	91.23	173.65	286.57
Blank Lot Prices						
9961		12#	33.48	64.08	148.99	274.02

(R)

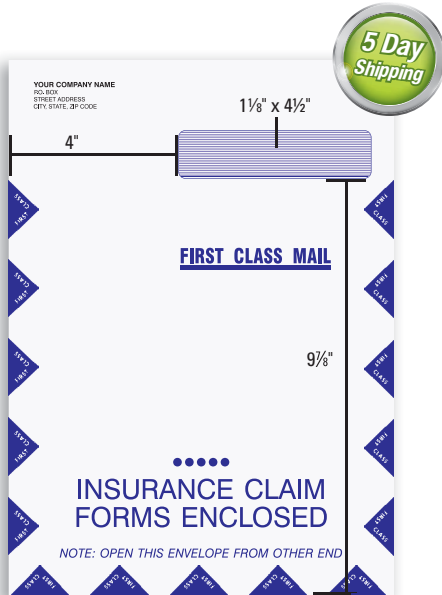

D **ENV-9961**
Large Claim Form Envelope, 9" x 12½"
Imprint area 1" x 4"

NOTE:



Includes your company's name, address and phone number in one of four colors! For blank forms, subtract 30% unless otherwise listed.



Colors correspond to sequence and number of parts selected in your order unless otherwise specified.



Secure Prescription Pads

E PP-2600, 2602
Secure Prescription Form Pad
5½" x 4¼" Horizontal
Imprint area 3¾" x 5"
1 pt-100 per pad
2 pt-50 per book

F PP-2601, 2603
Secure Prescription Form Pad
4¼" x 5½" Vertical
Imprint area 5" x 3¾"
1 pt-100 per pad
2 pt-50 per book

Security Features on all Prescription Pads:

- 1 True watermark paper with visible and invisible fibers, chemically reactive ink and bleach reactivity
- 2 Colored Background with Anti-Copy "VOID" Protection
- 3 Heat Sensitive Thermochromic Image
- 4 Micro Printing
- 5 Raster Relief Image
- 6 Warning Bands
- 7 Lot Control Number
- 8 Sequentially Numbered for Internal Record Keeping

Do you know the latest prescription pad legislation?

1. Prevent erasure or modification of prescription information.
2. Prevent the use of counterfeit prescription forms.
3. Prevent unauthorized copying of a completed or blank form.

These pads cover all three of these requirements!

Our prescription products are compliant with the latest new requirements for use of tamper resistant prescription pads under the Medicaid program, Section 1903b(i) of the Social Security Act (42USC193b(i), paragraph (23).

Compliant in all states except California, Connecticut, Kentucky, New Jersey, New York and Wyoming.

E PP-2600, 2601 - One Part Prescription Form Pad

Cat. No.	PP-	Pts.	H/V	Wt. per 8	Price Per Pad									
					4	8	12	16	20	40	80	120	160	200
2600-1	1	Horz	3#	15.18	9.36	7.49	6.50	6.24	5.46	5.36	5.25	5.15	4.89	
2601-1	1	Vert	3#	15.18	9.36	7.49	6.50	6.24	5.46	5.36	5.25	5.15	4.89	

Numbered by request only.

(R)

F PP-2602, 2603 - Two Part Prescription Form Books

Cat. No.	PP-	Pts.	H/V	Wt. per 8	Price Per Pad									
					8	16	24	32	40	80	120	180	240	300
2602-2	2	Horz	3#	12.17	8.48	8.11	7.80	7.07	6.81	6.55	6.50	6.45	6.34	
2603-2	2	Vert	3#	12.17	8.48	8.11	7.80	7.07	6.81	6.55	6.50	6.45	6.34	

Numbered by request only.

(R)

G ENV-9960 - Small Claim Form Envelope

Cat. No.	ENV-	Wt. per 500	Imprinted Lot Prices				
			500	1000	2000	3000	5000
9960		8#	103.02	121.73	235.84	312.85	475.74

(R)

H ENV-9968 - Small Claim Form Envelope

Cat. No.	ENV-	Wt. per 500	Imprinted Lot Prices				
			500	1000	2000	3000	5000
9968		8#	114.27	148.23	283.54	416.90	670.86

(R)

I ENV-9969 - Small Claim Form Envelope

Cat. No.	ENV-	Wt. per 500	Imprinted Lot Prices				
			500	1000	2000	3000	5000
9969		8#	100.32	133.42	257.69	375.69	592.12

(R)

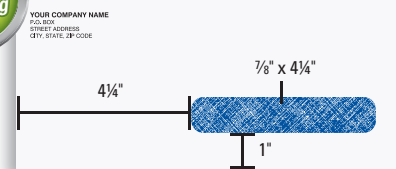

G ENV-9960
Small Claim Form Envelope, 4¼" x 9½"
Imprint area 1½" x 4¾"

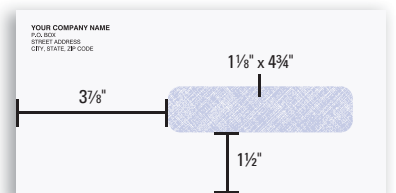

H ENV-9968
Small Claim Form Envelope, 4½" x 9½"
Imprint area 1½" x 4¾"

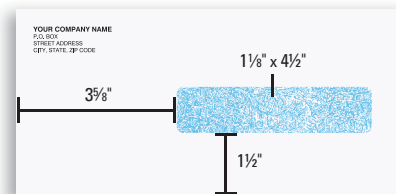

I ENV-9969
Small Claim Form Envelope, 4½" x 9"
Imprint area 1" x 5"

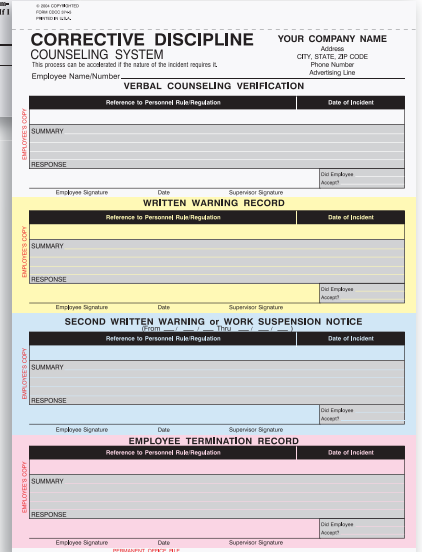
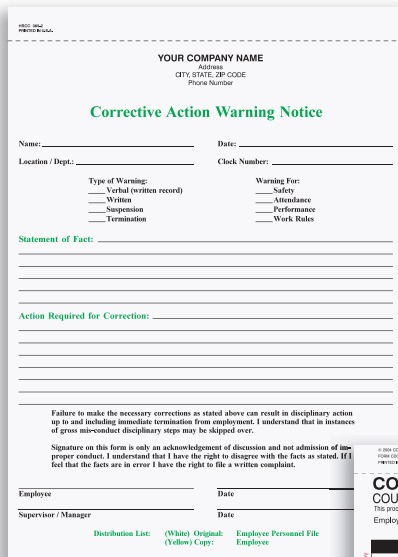
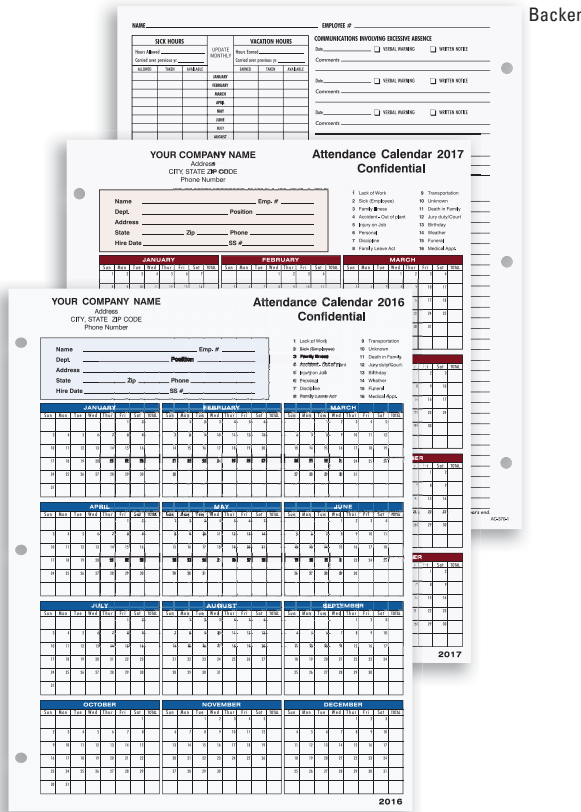

E **HRCC-365 - Snap-A-Part**
Corrective Action Warning Notice
8½" x 11"
Imprint area 1¼" x 6"

D **AC-370**
Attendance Calendar, 8½" x 11"
Imprint area ¾" x 4"

D **AC-370 - Attendance Calendar**

Cat. No.	AC-	Pts.	Wt. per Pkg	Imprinted Lot Prices			
				1 Pkgs	2 Pkgs	5 Pkgs	10 Pkgs
370-1	1	1#		57.92	105.51	233.90	375.37
Blank Lot Prices							
370-1	1	1#		44.72	78.90	167.96	276.51

Packaged in quantities of 50. (R)
Not available numbered.
2017 available upon request.

E **HRCC-365 - Corrective Action Warning Notice**

Cat. No.	HRCC-	Pts.	Wt. per 1000	Carbonless Lot Prices				
				250	500	1000	2000	3000
365-2	2	16#		85.50	124.98	210.97	380.99	551.56

Numbered by request only. (R)

F **CDCC-374 - Corrective Discipline Form**

Cat. No.	CDCC-	Pts.	Wt. per Pkg	Imprinted Carbonless Lot Prices				
				1 Pkg	2 Pkgs	5 Pkgs	10 Pkgs	20 Pkgs
374-5	5	1#		96.64	159.70	350.06	616.24	1,064.35
Blank Lot Prices								
374-5	5	1#		79.77	134.39	301.06	546.15	980.42

Packaged in quantities of 50. (R)
Not available numbered.

G **TERCC-363 - Travel Expense Report**

Cat. No.	TERCC-	Pts.	Wt. per 1000	Blank Carbonless Lot Prices				
				250	500	1000	2000	3000
363-2	2	16#		59.76	87.34	147.69	266.78	386.19

Not available imprinted or numbered. (R)

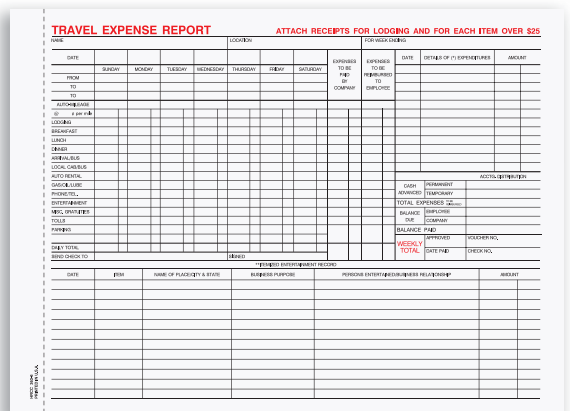

G **TERCC-363 - Snap-A-Part**
Travel Expense Report, 11" x 8½"

YOUR COMPANY NAME
Address
CITY, STATE, ZIP CODE
Phone Number
Advertising Line

NAME _____ DATE _____
ADDRESS _____ PHONE _____
APARTMENT _____ DATE PROMISED _____
MAKE _____ MODEL NO. _____ SERIAL NO. _____
DATE OF ORIGINAL INSTALLATION _____
NATURE OF SERVICE: ESTIMATE CASH WARRANTY CHARGE CONTRACT C.O.D.
QTY. _____ DESCRIPTION _____ PRICE _____ AMOUNT _____
REMARKS _____
TECHNICIAN _____ DATE COMPLETED _____ TAX _____ TOTAL _____
0001001
PRINTED IN U.S.A.

C SWO-207 - Register Form
Service Work Order, 5½" x 8½"
Imprint area 1" x 5"

ACCEPTED
CUSTOMER _____ DATE _____
W.O. NO. _____ MATERIAL _____
NO. PCS. _____ SER. NO. _____
PART NO. _____
INSPECTOR _____
COMMENTS _____

SCRAP
PRODUCT PART NO. _____ DESCRIPTION _____
QTY./WT. _____ PRODUCT/JOB NO. _____ VENDOR _____
OPERATOR _____ DEPT./WORK CTR. NO. _____
REASON _____
DISPOSITION _____
CHARGE TO ACCT NO. _____
INSPECTED BY _____ APPROVED BY _____

INSPECTED
PART NUMBER _____
INSPECTION OK, APPROVED FOR USE _____
REPAIRS MADE DURING INSPECTION, APPROVED FOR USE _____
RETURN FOR REWORK AND/OR REPAIRS _____
RETURN TO VENDOR _____
COMMENTS _____
DATE _____ INITIALS _____

REJECTED
JOB NO. _____ R.O. NO. _____
PART NO. _____ SERIAL NO. _____
PART NAME _____
NO. OF PIECES REJECTED _____
REASON _____
INSPECTOR _____ DATE _____

REPAIRABLE OR REWORK
CUSTOMER _____ DATE _____
JOB NO. _____ PART NAME _____
PART NO. _____ SER. NO. _____
NO. OF PIECES _____
DISPOSITION _____
INSR. _____ STAMP _____
REASON FOR REWORK (Use reverse side)

D PT-165, PTS-165 (w/string), PTW-165 (w/wire)
2¾" x 4¼"

C SWO-207 - Service Work Order

Cat. No.	Pts.	Wt. per 1000	Carbonless Lot Prices				
			250	500	1000	2000	3000
207-2	2	8#	77.60	101.40	142.93	237.68	327.78
207-3	3	12#	87.77	121.52	185.98	314.91	449.46

7 digit numbering only.

(R)

D PT-165, PTS-165, PTW-165 - Work Order Tags

Cat. No.	Description	Wt. per 1000	Blank Lot Prices			
			1000	2000	5000	10000
165-1	Accepted	5#	63.65	105.94	238.87	425.01
165-2	Scrap	5#	63.65	105.94	238.87	425.01
165-3	Inspected	5#	63.65	105.94	238.87	425.01
165-4	Rejected	5#	63.65	105.94	238.87	425.01
165-5	Repairable	5#	63.65	105.94	238.87	425.01
PTS- (with string)			Blank Lot Prices			
165-1	Accepted	6#	82.69	144.12	334.16	615.59
165-2	Scrap	6#	82.69	144.12	334.16	615.59
165-3	Inspected	6#	82.69	144.12	334.16	615.59
165-4	Rejected	6#	82.69	144.12	334.16	615.59
165-5	Repairable	6#	82.69	144.12	334.16	615.59
PTW- (with wire)			Blank Lot Prices			
165-1	Accepted	6#	83.34	145.31	337.41	621.97
165-2	Scrap	6#	83.34	145.31	337.41	621.97
165-3	Inspected	6#	83.34	145.31	337.41	621.97
165-4	Rejected	6#	83.34	145.31	337.41	621.97
165-5	Repairable	6#	83.34	145.31	337.41	621.97

Not available imprinted.

(R)

E SCB-115 - Service Call Book

Cat. No.	Pts.	Wt. per 5 Bks	Blank Carbonless Lot Prices				
			5 Bks	10 Bks	15 Bks	50 Bks	
115-2	2	5#	83.34	149.63	202.31	273.59	510.68

Numbered in red by request only.
Not available imprinted.

(R)

SERVICE CALL DATE _____ TIME _____
NAME _____ CALL TAKEN BY _____
ADDRESS _____ PHONE _____ CALL CENTER TO _____
SERVICE WANTED _____
DATE PROMISED _____ MON TUE WED THU FRI SAT SUN

SERVICE CALL DATE _____ TIME _____
NAME _____ CALL TAKEN BY _____
ADDRESS _____ PHONE _____ CALL CENTER TO _____
SERVICE WANTED _____
DATE PROMISED _____ MON TUE WED THU FRI SAT SUN

E SCB-115 - Wire Bound Book

Service Call Book, 5" x 4¼"
5" x 8½" overall
150 receipts per book

A **GSCC-652, GS-651 - Snap-A-Part**
 General Sales, 5½" x 8½"
 Imprint area 1" x 5"

B **GSCC-653, GS-654 - Snap-A-Part**
 General Sales, 4¼" x 7"
 Imprint area 1" x 3½"

A **GSCC-652, GS-651 - General Sales**

Cat. No.	Pts.	Wt. per 1000	Carbonless Lot Prices				
			250	500	1000	2000	3000
GSCC-652-2	2	9#	80.53	109.94	175.06	304.85	431.94
GSCC-652-3	3	13#	93.50	135.04	224.16	398.52	580.77
GSCC-652-4	4	17#	99.45	143.91	237.25	424.15	618.62
GS-			Carbon Lot Prices				
GS-651-2	2	10#	76.63	100.75	156.78	268.51	377.86
GS-651-3	3	16#	84.53	117.52	188.90	331.02	476.61
GS-651-4	4	22#	87.99	122.60	196.47	345.73	498.46

(R)

B **GSCC-653, GS-654 - General Sales**

Cat. No.	Pts.	Wt. per 1000	Carbonless Lot Prices				
			250	500	1000	2000	3000
GSCC-653-2	2	6#	74.04	95.77	146.50	247.74	345.84
GSCC-653-3	3	9#	82.04	112.76	180.25	314.91	451.30
GS-			Carbon Lot Prices				
GS-654-2	2	7#	71.55	91.34	137.20	229.78	321.40
GS-654-3	3	10#	77.50	103.13	161.43	277.70	392.46

(R)

C **GSCC-552 - General Sales**

Cat. No.	Pts.	Wt. per 1000	Carbonless Lot Prices				
			250	500	1000	2000	3000
GSCC-552-3	3	13#	89.07	128.55	213.56	379.59	552.97

Bilingual (R)

D **GSDCC-643 - General Sales Delivery Form**

Cat. No.	Pts.	Wt. per 1000	Carbonless Lot Prices				
			250	500	1000	2000	3000
GSDCC-643-2	2	9#	80.53	110.05	175.06	304.85	431.83

(R)

NOTE:

Company Imprint

Includes your company's name, address and phone number in one of four colors! For blank forms, subtract 30% unless otherwise listed.

Starting Number

Choose a six-digit number for your imprinted form, or seven-digit for all register forms at no extra charge! Otherwise, we will start with 001001 or 0001001. Four, five and custom seven-digit numbering available at an additional charge. See page 142 for pricing.

Multi-part Color Sequence

Colors correspond to sequence and number of parts selected in your order unless otherwise specified.

Blank forms will be sequentially numbered unless specified otherwise.

C **GSCC-552 - Snap-A-Part**
 General Sales, 5½" x 8½"
 Imprint area 1" x 5"
Bilingual

D **GSDCC-643 - Snap-A-Part**
 General Sales Delivery Form, 5½" x 8½"
 Imprint area 1¼" x 3½"



*Without layaway.

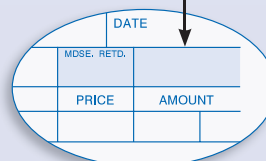

E GP-149*, GP-151 - Sales Book
 General Sales, 4¼" x 5½"
 Imprint area 1" x 3¾"
 50 sets per book

F GP-154, GP-158* - Sales Book
 General Sales, 4¼" x 7"
 Imprint area 1" x 3¾"
 50 sets per book

E GP-149*, GP-151 - General Sales Book

Cat. No.	GP-	Pts.	Wt. per 10 Bks	Carbonless Lot Prices			
				10 Bks	15 Bks	25 Bks	50 Bks
151-2	2	3#	100.10	128.98	188.47	324.42	594.50
151-3	3	4#	110.49	147.48	214.97	403.27	753.17
149-2*	2	3#	100.10	128.98	188.47	324.42	594.50
149-3*	3	4#	110.49	147.48	214.97	403.27	753.17

*Without layaway.

(R)

F GP-154, GP-158* - General Sales Book

Cat. No.	GP-	Pts.	Wt. per 10 Bks	Carbonless Lot Prices			
				10 Bks	15 Bks	25 Bks	50 Bks
154-2	2	4#	114.92	150.07	214.97	385.75	736.73
154-3	3	5#	129.74	165.76	249.90	447.30	858.41
158-2*	2	4#	114.92	150.07	214.97	385.75	736.73
158-3*	3	5#	129.74	165.76	249.90	447.30	858.41

*Without layaway.

(R)

G SOFCC-699, SOF-698 - Sales Order

Cat. No.	SOFCC-	Pts.	Wt. per 1000	Carbonless Lot Prices			
				250	500	1000	2000
699-3	3	25#	122.17	191.39	336.76	627.38	923.20

Cat. No.	SOF-	Pts.	Wt. per 1000	Carbon Lot Prices			
				250	500	1000	2000
698-3	3	29#	104.54	156.78	268.83	488.29	714.02

Envelopes available on page 100. (9907)

(R)

H GSCC-670 - General Sales

Cat. No.	GSCC-	Pts.	Wt. per 1000	Carbonless Lot Prices			
				250	500	1000	2000
670-2	2	16#	97.83	143.04	241.47	435.72	630.84
670-3	3	25#	122.17	191.39	336.76	627.38	923.20
670-4	4	32#	145.10	237.79	429.45	815.90	1,201.93

Envelopes available on page 100. (9906)

(R)

NOTE:



G SOFCC-699, SOF-698 - Snap-A-Part Sales Order, 8½" x 11"
 Imprint area 1" x 4"

H GSCC-670 - Snap-A-Part
 General Sales, 8½" x 11"
 Imprint area 1" x 4"



YOUR COMPANY NAME
Address
CITY, STATE, ZIP CODE
Phone Number
Advertising Line

NAME
ADDRESS
CITY, STATE, ZIP CODE
PHONE NO.
DATE

SOLD BY	CASH	C.O.D.	CHARGE	ON ACCT.	MISC. RETN.	PAID OUT	LAWYAY
QTY.	DESCRIPTION					PRICE	AMOUNT
							TAX
RECEIVED BY							TOTAL

No. 001001
ALL CLAIMS AND RETURNED GOODS MUST BE ACCOMPANIED BY THIS BILL.
Thank You

A GP-153, GP-159* - Sales Book
General Sales, 5 $\frac{1}{2}$ " x 8 $\frac{1}{2}$ "
Imprint area 1" x 5"
50 sets per book

*Without layaway.

MOSE. RETD.	DATE
PRICE	AMOUNT

YOUR COMPANY NAME
Address
CITY, STATE, ZIP CODE
Phone Number
Advertising Line

CUSTOMER'S ORDER NO. PHONE DATE
NAME
ADDRESS

SOLD BY	CASH	C.O.D.	CHARGE	ON ACCT.	MISC. RETN.	PAID OUT	
QTY.	DESCRIPTION					PRICE	AMOUNT
							TAX
RECEIVED BY							TOTAL

001001
All claims and returned goods MUST be accompanied by this bill.
Thank You

B GP-139 - Sales Book
General Sales, 8 $\frac{1}{2}$ " x 5 $\frac{1}{2}$ "
Imprint area 1" x 3"
50 sets per book

A GP-153, GP-159* - General Sales Book

Cat. No.	GP-	Pts.	Wt. per 10 Bks	Carbonless Lot Prices			
				10 Bks	15 Bks	25 Bks	50 Bks
153-2	2	6#	144.56	194.74	298.14	534.91	1,034.50
153-3	3	7#	152.45	205.13	315.56	592.88	1,104.15
159-2*	2	6#	144.56	194.74	298.14	534.91	1,034.50
159-3*	3	7#	152.45	205.13	315.56	592.88	1,104.15

*Without layaway.

B GP-139 - General Sales Book

Cat. No.	GP-	Pts.	Wt. per 10 Bks	Carbonless Lot Prices			
				10 Bks	15 Bks	25 Bks	50 Bks
139-2	2	6#	144.56	194.74	298.14	534.91	1,034.50
139-3	3	7#	152.45	205.13	315.56	592.88	1,104.15

C RSB-142 - Road Service Book

Cat. No.	RSB-	Pts.	Wt. per 10 Bks	Carbonless Lot Prices			
				10 Bks	15 Bks	25 Bks	50 Bks
142-2	2	6#	144.56	194.74	298.14	534.91	1,034.50
142-3	3	7#	152.45	205.13	315.56	592.88	1,104.15

D MB-012 - General Sales Book

Cat. No.	MB-	Pts.	Wt. per 25 Bks	Carbon Lot Prices			
				25 Bks	50 Bks	75 Bks	100 Bks
012-2	2	5#	63.76	100.32	109.40	127.57	211.72

Not available imprinted. No choice of starting number.

NOTE:



Includes your company's name, address and phone number in one of four colors! For blank forms, subtract 30% unless otherwise listed.



Colors correspond to sequence and number of parts selected in your order unless otherwise specified.



Choose a six-digit number for your imprinted form, or seven-digit for all register forms at no extra charge! Otherwise, we will start with 001001 or 0001001. Four, five and custom seven-digit numbering available at an additional charge. See page 142 for pricing.



Blank forms will be sequentially numbered unless specified otherwise.

YOUR COMPANY NAME
Address
CITY, STATE, ZIP CODE
Phone Number
Advertising Line
001001

ROAD SERVICE

DATE TIME PAID (RECORDED BY) (PAID)

LOCATION OF VEHICLE

NAME PHONE

ADDRESS ZIP

VEHICLE MILEAGE SERVICE TIME FEES EXTRA PERSON

START START START

TOTAL TOTAL TOTAL

YEAR MAKE/MODEL/COLOR VIN#

STATE LIC. NO. VEHICLE LIC. NO.

PROBLEM REPORTED	SERVICE RENDERED	SPECIAL EQUIPMENT	INDICATE DAMAGED AREAS ON VEHICLE
<input type="checkbox"/> CLUNK OUT <input type="checkbox"/> FLAT TIRE <input type="checkbox"/> OUT OF GAS <input type="checkbox"/> BRINE <input type="checkbox"/> RECOVERY	<input type="checkbox"/> BATTERY TOW <input type="checkbox"/> WHEEL LIFT <input type="checkbox"/> FLAT BED/RAMP <input type="checkbox"/> TOW <input type="checkbox"/>	<input type="checkbox"/> SINGLE LINE WINDING <input type="checkbox"/> DUAL LINE WINDING <input type="checkbox"/> SWITCH BLOCKS <input type="checkbox"/> SCOOTER BLOCKS <input type="checkbox"/> DOLLY <input type="checkbox"/>	<input type="checkbox"/>

VEHICLE TOWED TO

REMARKS

MECHANIC'S SIGNATURE AUTHORIZED SIGNATURE

TOTAL

Thank You

Date _____

No. _____

Reg. No.	Clerk	ACCOUNT FORWARDED
1		
2		
3		
4		
5		
6		
7		
8		
9		
10		
11		
12		
13		
14		
15		

12

For Account Used in One - 1 Error - Road Return on Card

C RSB-142
Road Service Book, 5 $\frac{1}{2}$ " x 8 $\frac{1}{2}$ "
Imprint area 1" x 3"
50 sets per book

D MB-012 - Sales Book
General Sales, 3 $\frac{1}{16}$ " x 5 $\frac{1}{8}$ "
50 sets per book

E MB-258, MB-358 - Sales Book
General Sales, 5½" x 7¾"
50 sets per book

F MB-247, MB-347 - Sales Book
General Sales, 4½" x 7"
50 sets per book

G GP-152 - Sales Book
General Sales, 4¼" x 5½"
Imprint area 1" x 3¾"
50 sets per book

E MB-258, MB-358 - General Sales Book

Cat. No.	Wt.		Carbonless Lot Prices
	MB-	Pts. per 10 Bks	
258-2	2	5#	45.59
358-3	3	6#	52.62

Not available imprinted. No choice of starting number. (R)

F MB-247, MB-347 - General Sales Book

Cat. No.	Wt.		Carbonless Lot Prices
	MB-	Pts. per 10 Bks	
247-2	2	4#	42.13
347-3	3	5#	45.59

Not available imprinted. No choice of starting number. (R)

G GP-152 - General Sales Book

Cat. No.	Wt.		Carbonless Lot Prices				
	GP-	Pts. per 10 Bks	10 Bks	15 Bks	25 Bks	50 Bks	100 Bks
152-2	2	3#	100.10	128.98	188.47	324.42	594.50

(R)

H GP-155 - Service Station Sales Book

Cat. No.	Wt.		Carbonless Lot Prices				
	GP-	Pts. per 10 Bks	10 Bks	15 Bks	25 Bks	50 Bks	100 Bks
155-2	2	3#	96.25	124.02	181.22	311.94	571.64
155-3	3	4#	106.24	141.81	206.70	387.76	724.41

(R)

H GP-155 - Sales Book
Service Station Sales, 4¼" x 5½"
Imprint area 1" x 3¾"
50 sets per book

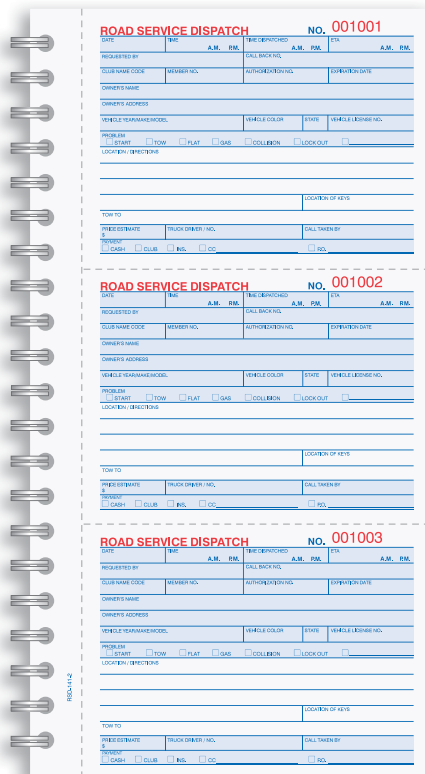

A RSD-141 - Wire Bound Book
Road Service Dispatch Book, 5 3/4" x 11" Overall
Receipt size 5" x 3 1/2"
150 sets per book

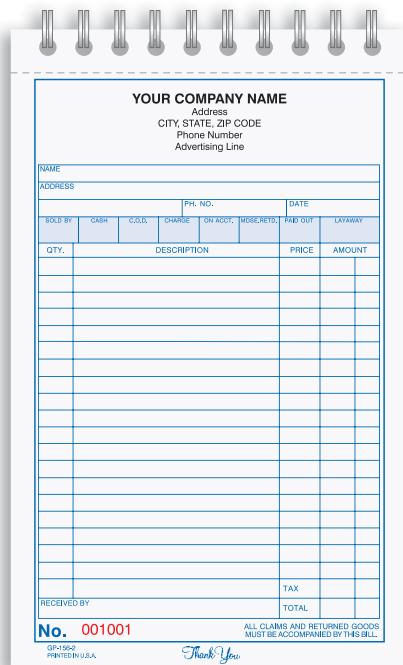

C GP-156 - Wire Bound Book
General Sales, 5 3/8" x 8 1/2"
Imprint area 1" x 5"
50 sets per book

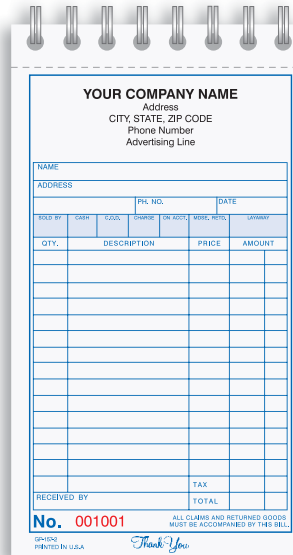

B GP-157 - Wire Bound Book
General Sales, 4 1/4" x 7"
Imprint area 1" x 3 3/8"
50 sets per book

A RSD-141 - Road Service Dispatch Book

Cat. No.	Wt.	Carbonless Lot Prices						
		RSD-	Pts.	per 5 Bks	5 Bks	10 Bks	15 Bks	25 Bks
141-2	2	5#	79.98	139.04	188.04	310.58	615.81	

Not available imprinted. No choice of starting number. (R)

B GP-157 - General Sales Book

Cat. No.	Wt.	Carbonless Lot Prices						
		GP-	Pts.	per 10 Bks	10 Bks	15 Bks	25 Bks	50 Bks
157-2	2	4#	128.22	165.76	236.92	447.08	805.95	
157-3	3	5#	142.14	186.85	276.19	490.88	946.56	

(R)

C GP-156 - General Sales Book

Cat. No.	Wt.	Carbonless Lot Prices						
		GP-	Pts.	per 10 Bks	10 Bks	15 Bks	25 Bks	50 Bks
156-2	2	6#	159.70	213.02	324.42	596.13	1,156.50	
156-3	3	7#	170.30	223.62	346.27	648.69	1,244.43	

(R)

NOTE:



Includes your company's name, address and phone number in one of four colors! For blank forms, subtract 30% unless otherwise listed.



Colors correspond to sequence and number of parts selected in your order unless otherwise specified.



Choose a six-digit number for your imprinted form, or seven-digit for all register forms at no extra charge! Otherwise, we will start with 001001 or 0001001. Four, five and custom seven-digit numbering available at an additional charge. See page 142 for pricing.

Blank forms will be sequentially numbered unless specified otherwise.



Register

A GS-224 - Register Form
 General Sales, 5½" x 8½"
 Imprint area 1" x 5"

B GS-222 - Register Form
 General Sales, 5½" x 8½"
 Imprint area 1" x 5"
Bilingual

C GSD-204 - Register Form
 Sales Delivery, 5½" x 8½"
 Imprint area 1" x 5"

A GS-224 - General Sales

Cat. No.	Gs-	Pts.	Wt. per 1000	Carbonless Lot Prices			
				250	500	1000	2000
224-2	2	8#	77.60	101.40	146.18	237.68	327.67
224-3	3	12#	87.78	121.52	185.98	314.91	449.35

(R)

B GS-222 - General Sales

Cat. No.	Gs-	Pts.	Wt. per 1000	Carbonless Lot Prices			
				250	500	1000	2000
222-3	3	12#	87.77	121.52	185.98	314.91	449.40

Bilingual (R)

C GSD-204 - Sales Delivery

Cat. No.	GSD-	Pts.	Wt. per 1000	Carbonless Lot Prices			
				250	500	1000	2000
204-2	2	8#	77.60	101.40	146.18	237.68	327.67
204-3	3	12#	87.77	121.52	185.98	314.91	449.35

(R)

NOTE:



Includes your company's name, address and phone number in one of four colors! For blank forms, subtract 30% unless otherwise listed.



Colors correspond to sequence and number of parts selected in your order unless otherwise specified.



Choose a seven or six-digit starting number with an A-Z (except letters I and O) prefix for your imprint form at no extra charge! Otherwise, we will start with 0001001.



Call for pricing on larger quantities.

Blank forms will be sequentially numbered unless specified otherwise.

A **GS-227 - Register Form**
General Sales, 4" x 6½"
Imprint area 1" x 3½"

B **GS-230 - Register Form**
General Sales, 4" x 6½"
Imprint area 1" x 3½"

C **GS-240 - Register Form**
General Sales, 4" x 6½"
Imprint area 1" x 3½"

A GS-227 - General Sales

Cat. No.		Wt.	Carbonless Lot Prices				
GS-	Pts.	per 1000	250	500	1000	2000	3000
227-2	2	5#	74.47	96.32	130.60	200.70	269.80
227-3	3	7#	84.42	108.97	155.26	250.23	345.84

(R)

B GS-230 - General Sales

Cat. No.		Wt.	Carbonless Lot Prices				
GS-	Pts.	per 1000	250	500	1000	2000	3000
230-2	2	5#	74.47	96.32	130.60	200.70	269.80
230-3	3	7#	84.42	108.97	155.26	250.23	345.84

(R)

C GS-240 - General Sales

Cat. No.		Wt.	Carbonless Lot Prices				
GS-	Pts.	per 1000	250	500	1000	2000	3000
240-2	2	5#	74.47	96.32	130.60	200.70	269.80
240-3	3	7#	84.42	108.97	155.26	250.23	345.84

(R)

NOTE:



Company Imprint

Includes your company's name, address and phone number in one of four colors! For blank forms, subtract 30% unless otherwise listed.



Multi-part Color Sequence

Colors correspond to sequence and number of parts selected in your order unless otherwise specified.



Starting Number

Choose a seven or six-digit starting number with an A-Z (except letters I and O) prefix for your imprint form at no extra charge! Otherwise, we will start with 0001001.



Shipping

Call for pricing on larger quantities.

Blank forms will be sequentially numbered unless specified otherwise.

YOUR COMPANY NAME
Address
CITY, STATE, ZIP CODE
Phone Number
Advertising Line

SOLD TO _____ PHONE _____

ADDRESS _____ CITY _____ STATE _____ ZIP _____

SOLD BY	DATE	CASH	CHECK	CHARGE	ON ACCT.	MOSE. RETD.	L'WAY	ALTERS.
QTY.	STYLE	DESCRIPTION			AMOUNT	COMMENTS		
SUB-TOTAL								
TAX								
TOTAL								

Thank You

FINAL SALE - NO RETURN

Merchandise for return or exchange MUST be accompanied by this sales receipt.

0001001 _____
CUSTOMER SIGNATURE

AP-217-3 PRINTED IN U.S.A.

A AP-217 - Register Form
Apparel, 5½" x 8½"
Imprint area 1" x 5"

YOUR COMPANY NAME
Address
CITY, STATE, ZIP CODE
Phone Number
Advertising Line

CUSTOMER ORDER NO. _____ PHONE _____ DATE _____

NAME _____
ADDRESS _____
SPECIAL ORDER
GIFT CERTIFICATE
LAY-A-WAY
TRADE-IN

SOLD BY	CASH	CHARGE	G.O.D.	CHECK	ON ACCT.	PAID OUT	MOSE. RETD.
QTY.	STOCK NO.	DESCRIPTION/SIZE		PRICE	AMOUNT		
SPECIAL INSTRUCTIONS:				SUBTOTAL			
				TAX			
				TOTAL			
				DEPOSIT			
				BAL. DUE			

ALL claims and returned goods MUST be accompanied by this bill.

0001001 _____
Rec'd by *Thank You*

GSR-225-3 PRINTED IN U.S.A.

C GSR-225 - Register Form
Retail Sales, 5½" x 8½"
Imprint area 1" x 5"

YOUR COMPANY NAME
Address
CITY, STATE, ZIP CODE
Phone Number
Advertising Line

SOLD TO _____ PHONE _____

ADDRESS _____ CITY _____ STATE _____ ZIP _____

SOLD BY	DATE	CASH	CHECK	CHARGE	ON ACCT.	MOSE. RETD.	L'WAY	ALTERS.
QTY.	STYLE	DESCRIPTION			AMOUNT	COMMENTS		
SUB-TOTAL								
TAX								
TOTAL								

Thank You

FINAL SALE - NO RETURNS

Merchandise for return or exchange MUST be accompanied by this sales receipt.

0001001 _____
CUSTOMER SIGNATURE

AP-232-2 PRINTED IN U.S.A.

B AP-232 - Register Form
Apparel, 4" x 6½"
Imprint area 1" x 3½"

A AP-217 - Apparel

Cat. No.	Pts.	Wt. per 1000	Carbonless Lot Prices				
			250	500	1000	2000	3000
217-2	2	8#	77.60	101.40	146.18	237.68	327.67
217-3	3	12#	87.78	121.52	185.98	314.91	449.35

(R)

B AP-232 - Apparel

Cat. No.	Pts.	Wt. per 1000	Carbonless Lot Prices				
			250	500	1000	2000	3000
232-2	2	5#	74.47	96.32	130.60	200.70	269.80

(R)

C GSR-225 - Retail Sales

Cat. No.	Pts.	Wt. per 1000	Carbonless Lot Prices				
			250	500	1000	2000	3000
225-2	2	8#	77.60	101.40	146.18	237.68	327.67
225-3	3	12#	87.78	121.52	185.98	314.91	449.35

(R)

NOTE:



Includes your company's name, address and phone number in one of four colors! For blank forms, subtract 30% unless otherwise listed.



Colors correspond to sequence and number of parts selected in your order unless otherwise specified.



Choose a seven or six-digit starting number with an A-Z (except letters I and O) prefix for your imprint form at no extra charge! Otherwise, we will start with 0001001.



Call for pricing on larger quantities.

Blank forms will be sequentially numbered unless specified otherwise.

ROAD SERVICE

YOUR COMPANY NAME
Address
CITY, STATE, ZIP CODE
Phone Number
Advertising Line

DATE _____ TIME _____ A.M. P.M. REQUESTED BY _____

LOCATION OF VEHICLE _____

NAME _____ PHONE _____

ADDRESS _____ ZIP _____

MILEAGE		SERVICE TIME		EXTRA PERSON	
FINISH	FINISH	FINISH	FINISH	FINISH	FINISH
START	START	START	START	START	START
TOTAL	TOTAL	TOTAL	TOTAL	TOTAL	TOTAL

YEAR _____ MAKE/MODEL/COLOR _____ DRIVER _____

STATE _____ LIC. NO. _____ VEHICLE ID. NO. _____

PROBLEM REPORTED	SERVICE RENDERED	SPECIAL EQUIPMENT	INDICATE DAMAGED AREAS ON VEHICLE
<input type="checkbox"/> LOCK OUT <input type="checkbox"/> FLAT TIRE <input type="checkbox"/> OUT OF GAS <input type="checkbox"/> WRECK <input type="checkbox"/> RECOVERY <input type="checkbox"/>	<input type="checkbox"/> SLING/HOIST TOW <input type="checkbox"/> WHEEL LIFT <input type="checkbox"/> FLAT BED/RAMP <input type="checkbox"/> START <input type="checkbox"/>	<input type="checkbox"/> SINGLE LINE WINCHING <input type="checkbox"/> DUAL LINE WINCHING <input type="checkbox"/> SNATCH BLOCKS <input type="checkbox"/> SCOTCH BLOCKS <input type="checkbox"/> DOLLY <input type="checkbox"/>	 KEYS LEFT Y N RADIO Y N

VEHICLE TOWED TO _____

REMARKS _____

MILEAGE CHARGE _____

TOWING CHARGE _____

LABOR CHARGE _____

STORAGE CHARGE _____

OPERATOR'S SIGNATURE _____ AUTHORIZED SIGNATURE _____

0001001 This company assumes no responsibility for loss or damage by theft, fire or any other cause beyond our service.

0001001 Printed in U.S.A. 

A RS-242 - Register Form
Road Service, 5½" x 8½"
Imprint area 1" x 5"

YOUR COMPANY NAME
Address
CITY, STATE, ZIP CODE
Phone Number
Advertising Line

Customer's Order No. _____ Date _____

Name _____

Address _____

QUAN.	DESCRIPTION	PRICE	AMOUNT
	GALS./ QTS. PRESSURE WASH		
	GALS./ QTS. OIL		
	GREASE		
	LUBRICATION		
	TAX		
CAT. NO. LICENSE NO. MILEAGE		TOTAL	

0001001 Rec'd by _____
All claims and returned goods MUST be accompanied by this bill.

0001001 Printed in U.S.A. 

B SS-213 - Register Form
Service Station, 4" x 6"
Imprint area 1" x 3½"

YOUR COMPANY NAME
Address
CITY, STATE, ZIP CODE
Phone Number
Advertising Line

Sold To _____ Date _____

Address _____

License No. _____ Mileage _____

QUAN.	DESCRIPTION	PRICE	AMOUNT
	<input type="checkbox"/> GALS./ QTS. LITERS LEAD FREE		
	<input type="checkbox"/> GALS./ QTS. LITERS REGULAR		
	<input type="checkbox"/> GALS./ QTS. LITERS DIESEL		
	QTS. OIL		
TAX			
TOTAL			

0001001 Rec'd by _____
All claims and returned goods MUST be accompanied by this bill.

0001001 Printed in U.S.A. 

C SS-236 - Register Form
Service Station, 4" x 6½"
Imprint area 1" x 3½"

REPAIR ORDER

YOUR COMPANY NAME
Address
CITY, STATE, ZIP CODE
Phone Number
Advertising Line

NAME _____ DATE _____

ADDRESS _____ PH. NO. _____

ODOMETER READING _____ VIN. NO. _____

MAKE AND MODEL _____ LICENSE NO. AND STATE _____ MOTOR NO. _____

USE: OIL BATTERY DRIVE OIL FLAT-REAR WIPERS TRANS. DEF. WASH POLISH

DESCRIPTION	INSTRUCTIONS	AMOUNT

QTY.	PART NO.	NAME OF PART	SALE AMT.	Total Labor	Total Parts
TOTAL PARTS				TOTAL	TOTAL
Qts. Oil				TAX	
Lbs. Grease				TOTAL AMOUNT	
TOTAL OIL-GREASE					

I hereby authorize the above repair work to be done along with the necessary material, and hereby grant you and/or your employees permission to operate the car, truck or vehicle herein described on streets, highways or elsewhere for the purpose of testing and/or inspection. An express mechanic's lien is hereby acknowledged on above car, truck or vehicle to secure the amount of repairs thereto.

Work Authorized by _____ Date Promised _____

Delivered to _____ Date Delivered _____

0001001 ESTIMATES FOR LABOR ONLY. MATERIAL, ADDITIONAL.

0001001 Printed in U.S.A. 

D ARO-282 - Register Form
Auto Repair, 5½" x 8½"
Imprint area 1" x 5"

A RS-242 - Road Service

Cat. No.	RS-	Pts.	Wt. per 1000	Carbonless Lot Prices			
				250	500	1000	2000
242-2	2	8#	74.62	97.50	140.56	228.54	315.07
242-3	3	12#	84.40	116.84	178.83	302.80	432.07

(R)

B SS-213 - Service Station

Cat. No.	SS-	Pts.	Wt. per 1000	Carbonless Lot Prices			
				250	500	1000	2000
213-2	2	5#	67.03	82.00	111.12	170.92	230.41
213-3	3	6#	73.79	95.32	135.77	219.08	302.48

(R)

C SS-236 - Service Station

Cat. No.	SS-	Pts.	Wt. per 1000	Carbonless Lot Prices			
				250	500	1000	2000
236-2	2	5#	71.60	92.61	125.58	192.98	259.42
236-3	3	7#	81.17	104.78	149.29	240.60	332.54

(R)

D ARO-282 - Auto Repair

Cat. No.	ARO-	Pts.	Wt. per 1000	Carbonless Lot Prices			
				250	500	1000	2000
282-2	2	8#	70.36	91.88	132.55	215.44	297.08
282-3	3	12#	79.61	110.19	168.53	285.43	407.32

(R)

NOTE:



Includes your company's name, address and phone number in one of four colors! For blank forms, subtract 30% unless otherwise listed.



Choose a seven or six-digit starting number with an A-Z (except letters I and O) prefix for your imprint form at no extra charge! Otherwise, we will start with 0001001.



Colors correspond to sequence and number of parts selected in your order unless otherwise specified.

Blank forms will be sequentially numbered unless specified otherwise.

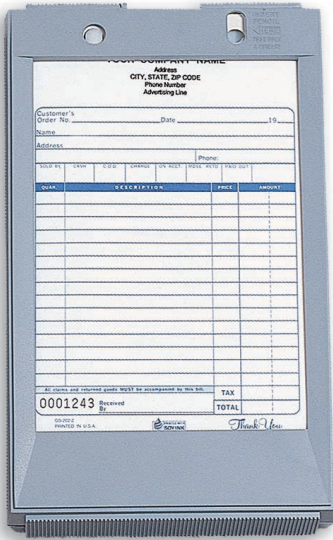

A Register Machine
(For three sizes of forms)
MAC-9970, 4" x 6", 4" x 6½"
Holds: 160 2pt, 110 3pt, 80 4pt
MAC-9973, 5½" x 8½"
Holds: 160 2pt, 110 3pt, 80 4pt

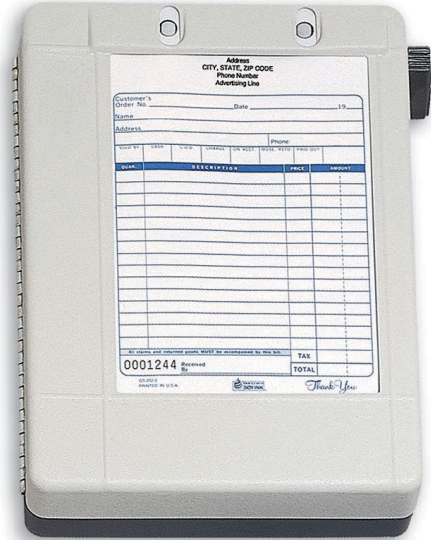

B Register Machine
(For three sizes of forms)
MAC-9972, 4" x 6", 4" x 6½"
Holds: 250 2pt, 160 3pt, 125 4pt
MAC-9975, 5½" x 8½"
Holds: 240 2pt, 140 3pt, 120 4pt

A MAC-9970, MAC-9973 - Register Machine – Heavy Plastic

Cat. No.	Size	Wt. each	Price each
9970	4" x 6", 4" x 6½"	2#	38.64
9973	5½" x 8½"	2#	52.26

(R)

B MAC-9972, MAC-9975 - Register Machine – Metal

Cat. No.	Size	Wt. each	Price each
9972	4" x 6", 4" x 6½"	4#	196.51
9975	5½" x 8½"	6#	232.28

Features pop-out drawer, thumb ejector and rubber feet.

(R)

C MAC-9968, MAC-9969 - Register Machine – Plastic

Cat. No.	Size	Wt. each	Price each
9968	4" x 6", 4" x 6½"	1#	10.35
9969	5½" x 8½"	1#	16.48

(R)



C Register Machine
(For three sizes of forms)
MAC-9968, 4" x 6", 4" x 6½"
Holds: 100 2pt, 75 3pt, 50 4pt
MAC-9969, 5½" x 8½"
Holds: 120 2pt, 70 3pt, 60 4pt

NOTE:

1
Day
Blank
Shipping

3
Day
Imprint

- See pages 6-19 for more Automotive Forms.
- Use a Sturdy Aluminum Form Holder for your Snap-A-Part Forms. See page 43.

FREE MACHINE
with your order of
1,000 or more imprinted
Register Forms!
Choose from **MAC-9968**
or **MAC-9969.**

Cash Receipt Books

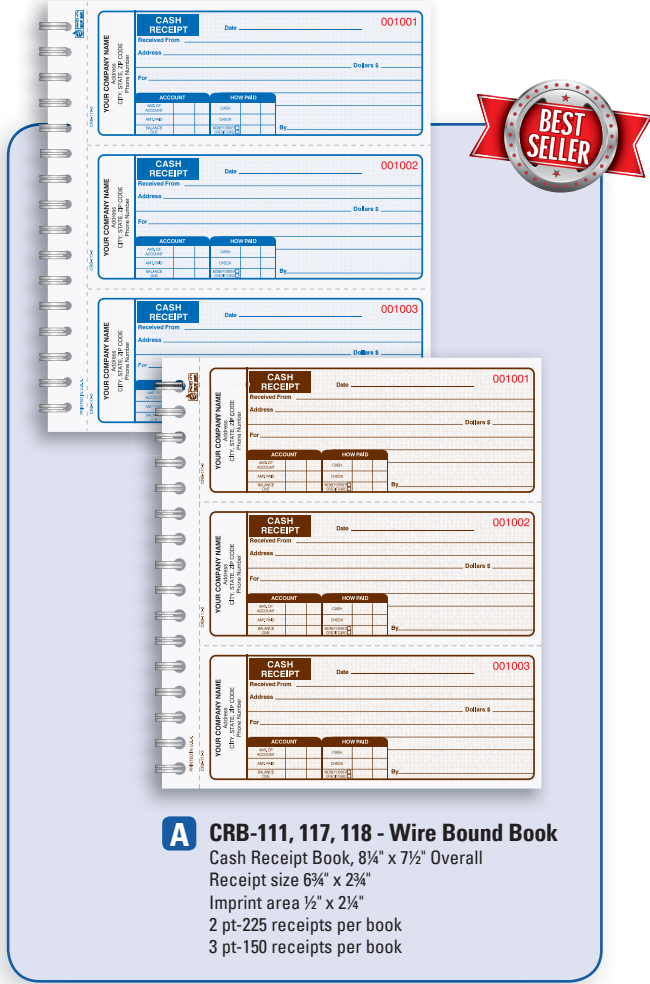

A **CRB-111, 117, 118 - Wire Bound Book**
Cash Receipt Book, 8 1/4" x 7 1/2" Overall
Receipt size 6 3/4" x 2 3/4"
Imprint area 1/2" x 2 1/4"
2 pt-225 receipts per book
3 pt-150 receipts per book

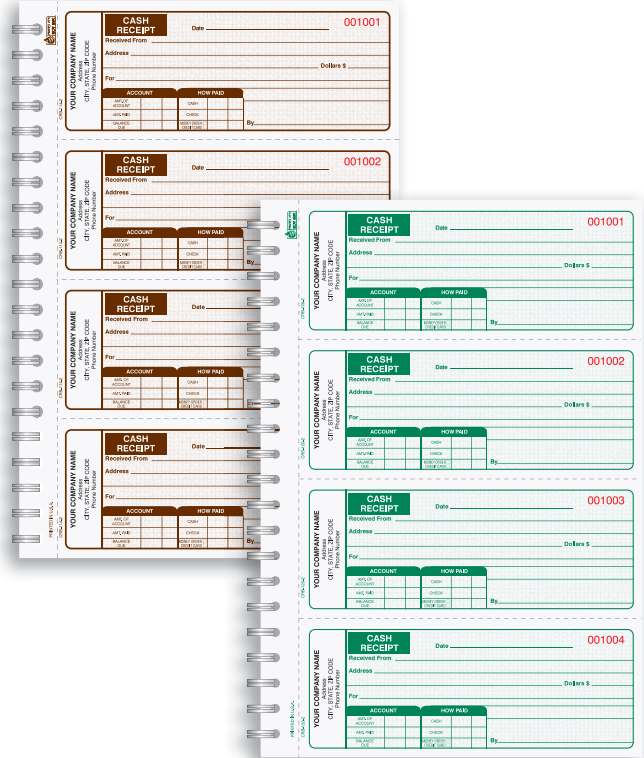

B **CRB-114, 119, 120 - Wire Bound Book**
Cash Receipt Book, 7 1/2" x 11" Overall
Receipt size 6 3/4" x 2 3/4"
Imprint area 1/2" x 2 1/4"
2 pt-300 receipts per book
3 pt-200 receipts per book

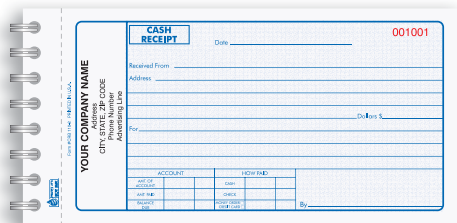

C **CRB-110 - Wire Bound Book**
Cash Receipt Book, 7 3/4" x 4 1/4"
Imprint area 1" x 3 1/2"
2 pt-75 receipts per book
3 pt-50 receipts per book

A **CRB-111, 117, 118 - Cash Receipt Book**

Cat. No.	CRB- Color	Pts.	Wt. per 5 Bks	Carbonless Lot Prices				
				5 Bks	10 Bks	15 Bks	25 Bks	50 Bks
111-2	Brown	2	5#	165.00	256.83	352.66	537.93	1,020.44
111-3	Brown	3	5#	165.00	256.83	352.66	537.93	1,020.44
117-2	Blue	2	5#	165.00	256.83	352.66	537.93	1,020.44
117-3	Blue	3	5#	165.00	256.83	352.66	537.93	1,020.44
118-2	Green	2	5#	165.00	256.83	352.66	537.93	1,020.44
118-3	Green	3	5#	165.00	256.83	352.66	537.93	1,020.44

(R)

B **CRB-114, 119, 120 - Cash Receipt Book**

Cat. No.	CRB- Color	Pts.	Wt. per 5 Bks	Carbonless Lot Prices				
				5 Bks	10 Bks	15 Bks	25 Bks	50 Bks
114-2	Brown	2	6#	218.00	352.33	489.26	715.53	1,256.23
114-3	Brown	3	6#	218.00	352.33	489.26	715.53	1,256.23
119-2	Blue	2	6#	218.00	352.33	489.26	715.53	1,256.23
119-3	Blue	3	6#	218.00	352.33	489.26	715.53	1,256.23
120-2	Green	2	6#	218.00	352.33	489.26	715.53	1,256.23
120-3	Green	3	6#	218.00	352.33	489.26	715.53	1,256.23

(R)

C **CRB-110 - Cash Receipt Book**

Cat. No.	CRB- Color	Pts.	Wt. per 5 Bks	Carbonless Lot Prices				
				5 Bks	10 Bks	15 Bks	25 Bks	50 Bks
110-2		2	3#	130.28	200.58	273.59	433.13	810.93
110-3		3	3#	130.28	200.58	273.59	433.13	810.93

(R)

Additional Cash Receipt Books on Page 16.

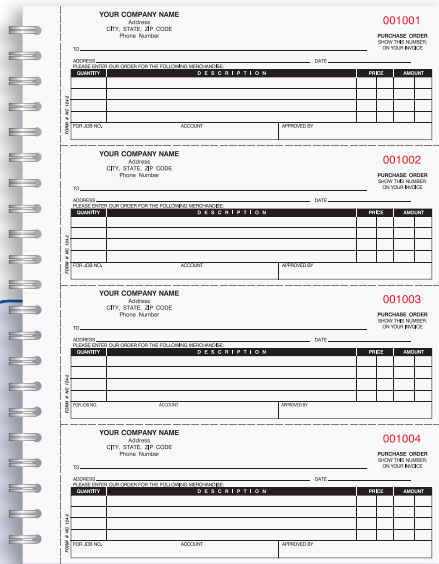

A NC-124 - Wire Bound Book
 Purchase Order Book, 8½" x 11" overall
 Receipt size 7½" x 2¾"
 Imprint area ½" x 5½"
 2pt-200 receipts per book
 3pt-200 receipts per book

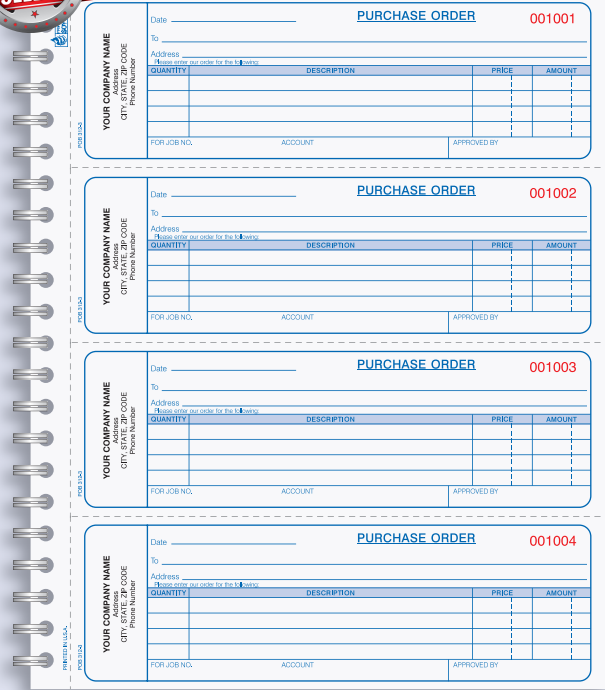

A NC-124 - Purchase Order Book

Cat. No.	NC-	Pts.	Wt. per 5Bks	Carbonless Lot Prices				
				5 Bks	10 Bks	15 Bks	25 Bks	50 Bks
124-2		2	5#	85.02	133.82	177.84	258.70	476.67
124-3		3	7#	113.28	178.02	237.12	345.80	635.26

Envelopes available on page 100. (9906) (R)

B POB-312 - Purchase Order Book

Cat. No.	POB-	Pts.	Wt. per 5Bks	Carbonless Lot Prices				
				5 Bks	10 Bks	15 Bks	25 Bks	50 Bks
312-3		3	6#	218.00	352.55	489.15	684.27	1,367.63

Envelopes available on page 100. (9906) (R)

C POB-311 - Purchase Order Book

Cat. No.	POB-	Pts.	Wt. per 5Bks	Carbonless Lot Prices				
				5 Bks	10 Bks	15 Bks	25 Bks	50 Bks
311-3		3	5#	165.00	256.83	352.66	537.93	1,020.44

Envelopes available on page 100. (9906) (R)

NOTE:



Company Imprint
 Includes your company's name, address and phone number in one of four colors! For blank forms, subtract 30% unless otherwise listed.



Multi-part Color Sequence
 Colors correspond to sequence and number of parts selected in your order unless otherwise specified.



Starting Number
 Choose a six-digit number for your imprinted form, or seven-digit for all register forms at no extra charge! Otherwise, we will start with 001001 or 0001001. Four, five and custom seven-digit numbering available at an additional charge. See page 142 for pricing.

Blank forms will be sequentially numbered unless specified otherwise.

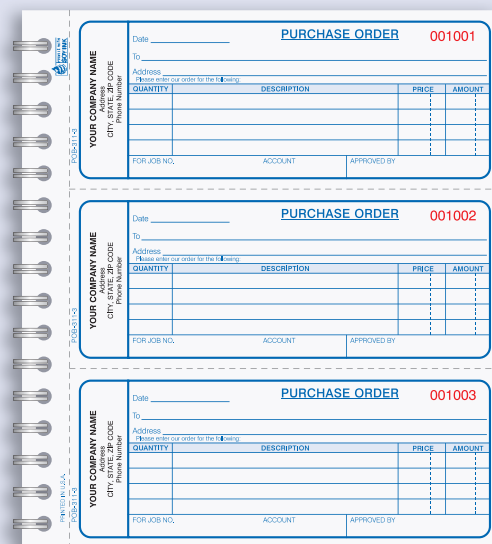

C POB-311 - Wire Bound Book
 Purchase Order Book, 6¾" x 8¼" overall
 Receipt size 6¾" x 2¾"
 Imprint area ½" x 2¼"
 150 receipts per book

Purchase Orders



YOUR COMPANY NAME
Address
CITY, STATE, ZIP CODE
Phone Number
Advertising Line

PURCHASE ORDER
Address
CITY, STATE, ZIP CODE
Phone Number
Advertising Line
001001

THE NUMBER MUST APPEAR ON ALL CORRESPONDENCE, INVOICES, SHIPPING PAPERS AND PACKAGES.

THESE ARE SUBJECT TO OUR PURCHASES AND APPROVAL. IF ORDERS WILL BE CREATED FOR ANY REASON, PLEASE USE IN ORDER TO AVOID CONFUSION. PLEASE CHECK THE NECESSARY FIELDS CAREFULLY AND PRINT ALL INFORMATION CORRECTLY AS SHOWN ON THE SCREEN.

TO

SHIP TO

PLEASE ENTER OUR ORDER FOR THE FOLLOWING TO BE SHIPPED AS DIRECTED:

QTY. ORDERED	QTY. RECEIVED	DESCRIPTION	UNIT PRICE	AMOUNT

PLEASE PRINT NAME AND ADDRESS OF PURCHASING AGENT.

PURCHASING AGENT

A **P0CC-707, PO-700 - Snap-A-Part**
Purchase Order, 8½" x 11"
Imprint area 1" x 4"

YOUR COMPANY NAME
Address
CITY, STATE, ZIP CODE
Phone Number
Advertising Line

PURCHASE ORDER
Address
CITY, STATE, ZIP CODE
Phone Number
Advertising Line
001001

THE NUMBER MUST APPEAR ON ALL CORRESPONDENCE, INVOICES, SHIPPING PAPERS AND PACKAGES.

THESE ARE SUBJECT TO OUR PURCHASES AND APPROVAL. IF ORDERS WILL BE CREATED FOR ANY REASON, PLEASE USE IN ORDER TO AVOID CONFUSION. PLEASE CHECK THE NECESSARY FIELDS CAREFULLY AND PRINT ALL INFORMATION CORRECTLY AS SHOWN ON THE SCREEN.

TO

SHIP TO

PLEASE ENTER OUR ORDER FOR THE FOLLOWING TO BE SHIPPED AS DIRECTED:

QTY. ORDERED	QTY. RECEIVED	DESCRIPTION	UNIT PRICE	AMOUNT

PLEASE PRINT NAME AND ADDRESS OF PURCHASING AGENT.

PURCHASING AGENT

B **P0CC-702, PO-701 - Snap-A-Part**
Purchase Order, 8½" x 8½"
Imprint area 1" x 4"

YOUR COMPANY NAME
Address
CITY, STATE, ZIP CODE
Phone Number
Advertising Line

PURCHASE ORDER
Address
CITY, STATE, ZIP CODE
Phone Number
Advertising Line
001001

THE NUMBER MUST APPEAR ON ALL CORRESPONDENCE, INVOICES, SHIPPING PAPERS AND PACKAGES.

THESE ARE SUBJECT TO OUR PURCHASES AND APPROVAL. IF ORDERS WILL BE CREATED FOR ANY REASON, PLEASE USE IN ORDER TO AVOID CONFUSION. PLEASE CHECK THE NECESSARY FIELDS CAREFULLY AND PRINT ALL INFORMATION CORRECTLY AS SHOWN ON THE SCREEN.

TO

SHIP TO

PLEASE ENTER OUR ORDER FOR THE FOLLOWING TO BE SHIPPED AS DIRECTED:

QTY. ORDERED	QTY. RECEIVED	DESCRIPTION	UNIT PRICE	AMOUNT

PLEASE PRINT NAME AND ADDRESS OF PURCHASING AGENT.

PURCHASING AGENT

C **P0CC-704, PO-703 - Snap-A-Part**
Purchase Order, 8½" x 7"
Imprint area 1" x 4"

A **P0CC-707, PO-700 - Purchase Order**

Cat. No.	Pts.	Wt. per 1000	Carbonless Lot Prices				
			250	500	1000	2000	3000
707-2	2	16#	97.83	143.04	241.47	435.72	630.84
707-3	3	25#	122.17	191.39	336.76	627.38	923.20
707-4	4	32#	145.10	237.79	429.45	815.90	1,201.93
707-5	5	40#	166.51	279.86	517.92	1,001.32	1,466.27

PO-	Pts.	Wt. per 1000	Carbon Lot Prices				
			250	500	1000	2000	3000
700-2	2	19#	89.07	126.39	207.94	370.50	530.69
700-3	3	29#	104.54	156.78	268.83	488.29	714.02
700-4	4	39#	119.14	186.85	327.35	611.92	895.40

Envelopes available on page 100. (9907) (R)

B **P0CC-702, PO-701 - Purchase Order**

Cat. No.	Pts.	Wt. per 1000	Carbonless Lot Prices				
			250	500	1000	2000	3000
702-3	3	20#	108.32	164.78	284.30	522.58	763.01
702-4	4	26#	126.38	200.70	358.39	667.29	979.44

PO-	Pts.	Wt. per 1000	Carbon Lot Prices				
			250	500	1000	2000	3000
701-3	3	22#	95.02	137.96	230.54	414.42	599.69

Envelopes available on page 100. (9907) (R)

C **P0CC-704, PO-703 - Purchase Order**

Cat. No.	Pts.	Wt. per 1000	Carbonless Lot Prices				
			250	500	1000	2000	3000
704-2	2	12#	86.26	120.33	195.28	343.14	498.02
704-3	3	16#	103.02	154.51	262.45	479.31	695.96

PO-	Pts.	Wt. per 1000	Carbon Lot Prices				
			250	500	1000	2000	3000
703-3	3	18#	90.69	129.52	214.97	382.94	553.08
703-4	4	25#	100.75	149.96	254.99	463.63	673.13

Envelopes available on page 100. (9907) (R)

NOTE: **!** For an English/Spanish Bilingual Purchase Order, P0CC-717 is the form you need.

POCC-706 - Snap-A-Part
Purchase Order, 5½" x 8½"
Imprint area ⅞" x 3"

D **POCC-706 - Snap-A-Part**
Purchase Order, 5½" x 8½"
Imprint area ⅞" x 3"

POCC-708 - Snap-A-Part
Purchase Order, 8½" x 8½"
Imprint area 1" x 4"

E **POCC-708 - Snap-A-Part**
Purchase Order, 8½" x 8½"
Imprint area 1" x 4"

D **POCC-706 - Purchase Order**

Cat. No.	Pts.	Wt. per 1000	Carbonless Lot Prices				
			250	500	1000	2000	3000
706-2	2	9#	80.53	110.05	175.06	304.85	431.83
706-3	3	13#	93.50	135.04	224.16	398.52	580.76

Envelopes available on page 100. (9919) (R)

E **POCC-708 - Purchase Order**

Cat. No.	Pts.	Wt. per 1000	Carbonless Lot Prices				
			250	500	1000	2000	3000
708-3	3	20#	108.32	164.78	284.30	522.58	763.01

Envelopes available on page 100. (9907) (R)

F **POCC-717 - Purchase Order**

Cat. No.	Pts.	Wt. per 1000	Carbonless Lot Prices				
			250	500	1000	2000	3000
717-3	3	25#	122.17	191.39	336.76	627.38	923.20

Envelopes available on page 100. (9907) (R)
Bilingual

POCC-717 - Snap-A-Part
Purchase Order, 8½" x 11"
Imprint area 1" x 4"
Bilingual

F **POCC-717 - Snap-A-Part**
Purchase Order, 8½" x 11"
Imprint area 1" x 4"
Bilingual

NOTE:



Includes your company's name, address and phone number in one of four colors! For blank forms, subtract 30% unless otherwise listed.



Choose a six-digit number for your imprinted form, or seven-digit for all register forms at no extra charge! Otherwise, we will start with 001001 or 0001001. Four, five and custom seven-digit numbering available at an additional charge. See page 142 for pricing.

Blank forms will be sequentially numbered unless specified otherwise.



Colors correspond to sequence and number of parts selected in your order unless otherwise specified.



Shipping & Receiving

Keep Your Shipments Moving!

Preprinted headings and plenty of room to list number of units shipped, type of packaging, weight, rate, charges and more make these forms easy to use.

Includes three areas for imprinting your information
8½" x 7" or 8½" x 11"

At the Top: (Choose one)

- 1 Your company name - 1 line of type, or
- 2 Your company name - 3 lines of type, or
- 4 Your company name, address and phone number - 4 lines of type.

In the Description Area:

- 3 List any six items - imprint up to six standard items and save time.

At the Bottom: (Choose one)

- 5 Your company name - imprint your name as carrier, 1 line of type, or
- 6 Your company name - imprint your name as shipper, 1 line of type.

Additional areas or lines of type, \$18.40(R)



PRINTED WITH SOY INK

STRAIGHT BILL OF LADING ORIGINAL - NOT NEGOTIABLE

Shipper No. _____
Carrier No. _____
Date _____

(Name of Carrier) (SCAC)

TO: Consignee (On Callback on Delivery shipments, the letters "COD" must appear before consignee's name - or as otherwise provided in Item 430, Sec. 1)
Street _____
Destination _____ Zip Code _____

FROM: Shipper
Street _____
Origin _____ Zip Code _____

Vehicle Number _____ U.S. DOT Hazard Reg. Number _____

No. Shipping Units	HM	Kind of Packaging, Description of Articles, Special Marks and Exceptions	U.N. NUMBER	Weight (Gross to Net)	RATE	CHARGES

REMIT C.O.D. TO: ADDRESS _____

COD Amt: \$ _____

C.O.D. FEE: PREPAID COLLECT \$ _____

TOTAL CHARGES: \$ _____

SHIPPER PER _____ CARRIER PER _____ DATE _____

EMERGENCY RESPONSE TELEPHONE NUMBER: _____

This is to certify that the herein named materials are properly classified, described, packaged, marked and labeled and are in proper condition for transportation according to the applicable regulations of the Department of Transportation.

Marked as all times the Hazardous Material is in transportation including storage incidental to transportation (192.004)



PRINTED WITH SOY INK

STRAIGHT BILL OF LADING ORIGINAL - NOT NEGOTIABLE

Shipper No. _____
Carrier No. _____
Date _____

(Name of Carrier) (SCAC)

TO: Consignee (On Callback on Delivery shipments, the letters "COD" must appear before consignee's name - or as otherwise provided in Item 430, Sec. 1)
Street _____
Destination _____ Zip Code _____

FROM: Shipper
Street _____
Origin _____ Zip Code _____

Vehicle Number _____ U.S. DOT Hazard Reg. Number _____

No. Shipping Units	HM	Kind of Packaging, Description of Articles, Special Marks and Exceptions	U.N. NUMBER	Weight (Gross to Net)	RATE	CHARGES

REMIT C.O.D. TO: ADDRESS _____

COD Amt: \$ _____

C.O.D. FEE: PREPAID COLLECT \$ _____

TOTAL CHARGES: \$ _____

SHIPPER PER _____ CARRIER PER _____ DATE _____

EMERGENCY RESPONSE TELEPHONE NUMBER: _____

Marked as all times the Hazardous Material is in transportation including storage incidental to transportation (192.004)

A BLCC-604 - Snap-A-Part
Bill of Lading, 8½" x 11"
Imprint area varies by selection.

See Page 71
for pricing.

B BLCC-602, BL-601 - Snap-A-Part
Bill of Lading, 8½" x 7"
Imprint area varies by selection.

A BLCC-604 - Bill of Lading

Cat. No.	Pts.	Wt. per 1000	Carbonless Lot Prices				
			250	500	1000	2000	3000
604-3	3	25#	122.17	191.39	336.76	627.38	923.20
604-4	4	32#	145.10	237.79	429.34	815.90	1,201.93

Available numbered in red on request. (R)
All parts white.

B BLCC-602, BL-601 - Bill of Lading

Cat. No.	Pts.	Wt. per 1000	Carbonless Lot Prices				
			250	500	1000	2000	3000
602-3	3	16#	103.02	154.51	262.45	479.31	695.96
602-4	4	22#	118.38	185.44	324.43	593.31	886.64
BL-		Carbon Lot Prices					
601-3	3	18#	91.34	131.58	216.48	377.32	546.15
601-4	4	25#	101.51	151.26	252.61	458.44	663.40

Numbered by request only. (R)
All parts white.

C BBLCC-620, BBL-621, 321 - Freight Bill/Bill of Lading

Cat. No.	Pts.	Wt. per 1000	Carbonless Lot Prices				
			250	500	1000	2000	3000
620-5	5	21#	131.90	202.85	312.10	592.99	842.73
BBL-		Carbon Lot Prices					
621-5	5	26#	113.95	175.60	306.04	565.41	828.34
321-5*	5	26#	113.95	175.60	306.04	565.41	828.34

*California version not shown. (R)
Numbered by request only.

D PLCC-630 - Packing List

Cat. No.	Pts.	Wt. per 1000	Carbonless Lot Prices				
			500	1000	2000	3000	
630-2	2	11#	86.26	120.33	195.28	343.14	498.02
630-3	3	16#	103.02	154.51	262.45	479.31	695.96

Envelopes available on page 100. (9907) (R)

E PLE-9430 - Packing List Envelope

Cat. No.	Pts.	Wt. per 1000	Stock Lot Prices			
			500	1000	2000	5000
9430	1	9#	70.90	103.67	183.17	430.64

For use with item D. (R)

NOTE:



Includes your company's name, address and phone number in one of four colors! For blank forms, subtract 30% unless otherwise listed.

Numbering

Forms will **NOT** be sequentially numbered unless specified otherwise.



Colors correspond to sequence and number of parts selected in your order unless otherwise specified.



C BBLCC-620, BBL-621, 321 - Snap-A-Part Freight Bill/Bill of Lading, 8½" x 5½" Imprint area 1" x 3"

D PLCC-630 - Snap-A-Part Packing List, 8½" x 7" Imprint area ¾" x 4"



E PLE-9430 - Envelope Packing List Envelope, 4½" x 5½"

Use Shipping Labels to make sure address information can be easily seen and read. See page 113 for our extensive selection.

Shipping & Receiving

Shipping Order form template. Fields include: YOUR COMPANY NAME, Address, CITY, STATE, ZIP CODE, Phone Number, Advertising Line, SHIPPER NUMBER 001001, SHIPPED TO, DATE SHIPPED, CUSTOMER'S ORDER NUMBER, OUR NUMBER, SHIPPED VIA, QUANTITY (ORDERED, SHIPPED), DESCRIPTION, HOW PACKED, REC'D BY, and a Thank You message.

Return to Vendor form template. Fields include: YOUR COMPANY NAME, Address, CITY, STATE, ZIP CODE, Phone Number, Advertising Line, RETURN TO VENDOR 001001, DATE, OUR P.O. NO., AUTHORIZATION NO., PERSON AUTHORIZING RETURN, HOW RETURNED, SHIPPING CHARGES (INSURE, COLLECT), a table for item tracking (QTY RETD., YOUR INVOICE NO., STOCK NUMBER, DESCRIPTION, UNIT PRICE, TOTAL AMOUNT), REASON FOR RETURN (OVERSOLD, OVERSHIPMENT, etc.), ACTION REQUESTED (REPAIR AND RETURN, etc.), SUB-TOTAL, TAX, and TOTAL.

A SOCC-629, SO-620 - Snap-A-Part
Shipping Order, 8½" x 7"
Imprint area 1" x 3½"

B RV-643 - Snap-A-Part
Return to Vendor Form, 8½" x 7"
Imprint area 1" x 3½"

Two forms shown: **Delivery Receipt** and **Receiving Form**. The Delivery Receipt includes fields for FROM (YOUR COMPANY NAME), TO (DEPARTMENT), and a table for QUANTITY, PRODUCT NO., and DESCRIPTION. The Receiving Form includes fields for YOUR COMPANY NAME, ADDRESS, DATE, and a table for QUANTITY, PRODUCT NO., and DESCRIPTION.

C DRCC-642 - Snap-A-Part
Delivery Receipt, 5¾" x 8½"
Imprint area 1" x 3"

Receiving Form template. Fields include: YOUR COMPANY NAME, Address, CITY, STATE, ZIP CODE, Phone Number, Advertising Line, RECEIVING FORM 001001, RECEIVED FROM, ADDRESS, DATE, FREIGHT ORDER NO. OR RETURNED GOODS, PREPARED, COLLECT, VIA, FREIGHT BILL NO., a table for QUANTITY, PRODUCT NO., DESCRIPTION, REMARKS, CONDITIONS, ETC., NO. PACKAGES, WEIGHT, RECEIVED BY, CHECKED BY, DELIVERED BY.

D RFCC-641, RF-640 - Snap-A-Part
Receiving Form, 5¾" x 8½"
Imprint area 1" x 3"

A SOCC-629, SO-620 - Shipping Order

Cat. No.	Pts.	Wt. per 1000	Carbonless Lot Prices				
			250	500	1000	2000	3000
SOCC-629-3	3	16#	103.02	154.51	262.45	479.31	695.96
SO-		Carbon Lot Prices					
620-3	3	18#	90.69	129.52	214.97	382.94	553.08

Envelopes available on page 100. (9906)

B RV-643 - Return to Vendor Form

Cat. No.	Pts.	Wt. per 1000	Carbonless Lot Prices				
			250	500	1000	2000	3000
RV-643-3	3	16#	103.02	154.51	262.45	479.31	695.96

Envelopes available on page 100. (9906, 9907)

C DRCC-642 - Delivery Receipt

Cat. No.	Pts.	Wt. per 1000	Carbonless Lot Prices				
			250	500	1000	2000	3000
DRCC-642-2	2	9#	80.53	110.05	175.06	304.85	431.94
642-3	3	13#	93.50	135.04	224.16	398.52	580.77

(R)

D RFCC-641, RF-640 - Receiving Form

Cat. No.	Pts.	Wt. per 1000	Carbonless Lot Prices				
			250	500	1000	2000	3000
RFCC-641-3	3	13#	93.50	135.04	224.16	398.52	580.77
RF-		Carbon Lot Prices					
640-3	3	16#	84.42	117.52	188.90	331.02	476.61

(R)

NOTE:



Includes your company's name, address and phone number in one of four colors! For blank forms, subtract 30% unless otherwise listed.



Colors correspond to sequence and number of parts selected in your order unless otherwise specified.



Choose a six-digit number for your imprinted form, or seven-digit for all register forms at no extra charge! Otherwise, we will start with 001001 or 0001001. Four, five and custom seven-digit numbering available at an additional charge. See page 142 for pricing.

Blank forms will be sequentially numbered unless specified otherwise.

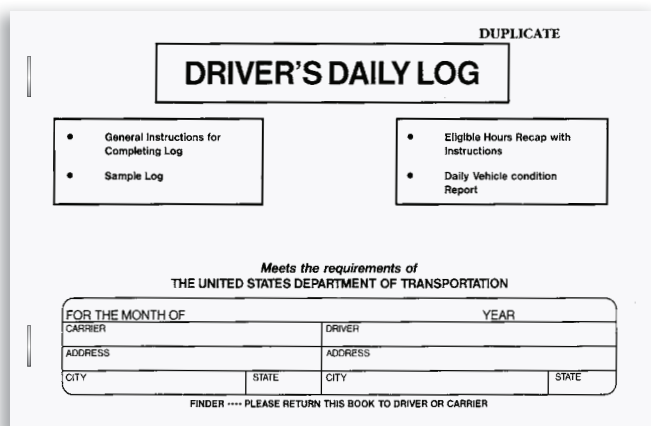

Cover

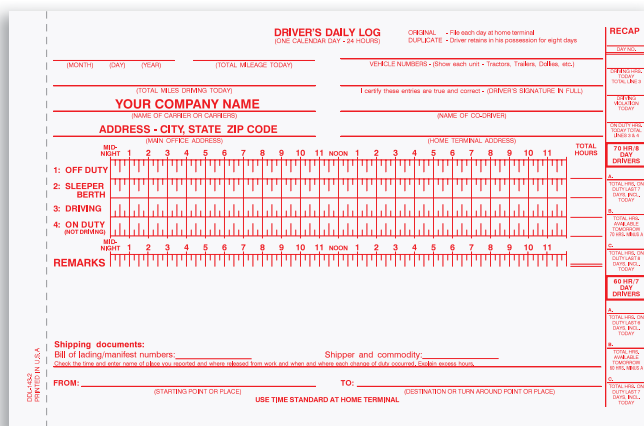

Inside Page

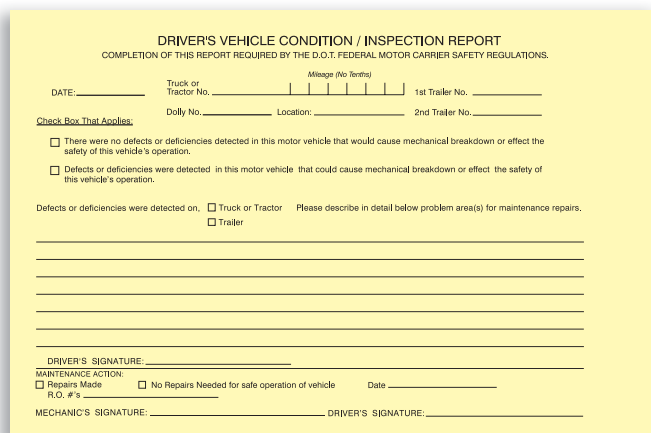

Backer

E DDL-143 - Driver's Log Book
 Stitch bound with wrap around cover, 8½" x 5½"
 Imprint area ½" x 3¼"
 31 sets per book, now includes pencil carbon

F DDL-343 - Driver's Log Book (No DVIR Backer)
 Stitch bound with wrap around cover, 8½" x 5½"
 Imprint area ½" x 3¼"
 31 sets per book

E DDL-143 - Driver's Log Book

Cat. No.	Pts.	Wt. per 10 Bks	Carbonless Lot Prices				
			10 Bks	15 Bks	25 Bks	50 Bks	100 Bks
143-2	2	4#	120.87	172.46	274.67	523.55	1,012.65

Not available numbered. (R)
 Now includes pencil carbon.

F DDL-343 - Driver's Log Book (No DVIR Backer)

Cat. No.	Pts.	Wt. per 10 Bks	Carbonless Lot Prices				
			10 Bks	15 Bks	25 Bks	50 Bks	100 Bks
343-2	2	4#	118.49	169.11	269.26	513.27	992.85

Not available numbered. (R)

G REQCC-574 - Stock Requisition

Cat. No.	Pts.	Wt. per 1000	Carbonless Lot Prices				
			250	500	1000	2000	3000
574-3	3	13#	79.12	108.11	170.73	292.84	420.26

Not available imprinted. (R)
 Numbered by request only.

G REQCC-574 - Snap-A-Part
 Stock Requisition Form, 8½" x 5½"





PRINTED WITH SOY INK

YOUR COMPANY NAME
Address
CITY, STATE, ZIP CODE
Phone Number
Advertising Line

INVOICE
001001

DATE:

CUST. ORDER NO.	DATE SHIPPED	SHIPPED VIA	TERMS	SALESMAN	C.O.B.	OUR ORDER NO.	QTY. ORDERED	SQ. ORDERED	DESCRIPTION	UNIT PRICE	AMOUNT

INVCC-750
PRINTED IN U.S.A.

Thank You

A **INVCC-750, INV-751 - Snap-A-Part**
Invoice, 8½" x 11"
Imprint area 1" x 4"

View forms in detail at:
www.bfands.com

A **INVCC-750, INV-751 - Invoice**

Cat. No.	Pts.	Wt. per 1000	Carbonless Lot Prices				
			250	500	1000	2000	3000
750-2	2	16#	97.83	143.04	241.47	435.72	630.84
750-3	3	25#	122.17	191.39	336.76	627.38	923.20
750-4	4	32#	145.10	237.79	429.45	815.90	1,201.93
INV-	Carbon Lot Prices						
751-3	3	29#	104.54	156.78	268.83	488.29	714.02
751-4	4	39#	119.14	186.85	327.35	611.92	895.40
751-5	5	48#	135.04	218.00	389.11	735.43	1,081.22

Envelopes available on page 100. (9907)

(R)

B **INVCC-753, INV-752 - Invoice**

Cat. No.	Pts.	Wt. per 1000	Carbonless Lot Prices				
			250	500	1000	2000	3000
753-3	3	20#	108.32	164.78	284.30	522.58	763.01
753-4	4	26#	126.38	200.69	358.38	667.30	979.44
INV-	Carbon Lot Prices						
752-3	3	22#	95.02	137.96	230.54	414.31	599.69
752-4	4	31#	106.05	160.78	276.94	506.68	737.92

Envelopes available on page 100. (9907)

(R)

PRINTED WITH SOY INK

YOUR COMPANY NAME
Address
CITY, STATE, ZIP CODE
Phone Number
Advertising Line

INVOICE
001001

DATE:

CUST. ORDER NO.	DATE SHIPPED	SHIPPED VIA	TERMS	SALESMAN	C.O.B.	OUR ORDER NO.	QTY. ORDERED	SQ. ORDERED	DESCRIPTION	UNIT PRICE	AMOUNT

INVCC-753
PRINTED IN U.S.A.

Thank You

B **INVCC-753, INV-752 - Snap-A-Part**
Invoice, 8½" x 8½"
Imprint area 1" x 4"

NOTE:



Includes your company's name, address and phone number in one of four colors! For blank forms, subtract 30% unless otherwise listed.



Colors correspond to sequence and number of parts selected in your order unless otherwise specified.



Choose a six-digit number for your imprinted form, or seven-digit for all register forms at no extra charge! Otherwise, we will start with 001001 or 0001001. Four, five and custom seven-digit numbering available at an additional charge. See page 142 for pricing.



Blank forms will be sequentially numbered unless specified otherwise.

C **INVC-755, INV-754 (Ruled), INVCC-765, INV-764 (Unruled) - Snap-A-Part**
Invoice, 8½" x 7"
Imprint area 1" x 4"

D **INVCC-760 - Snap-A-Part**
Invoice, 8½" x 5½"
Imprint area ¾" x 3"

C **INVC-755, INV-754, INVCC-765, INV-764 - Invoice**

Cat. No.	Pts.	Wt. per 1000	Carbonless Lot Prices				
			250	500	1000	2000	3000
INVC-755-2	2	11#	86.26	120.33	195.28	343.14	498.02
INVC-755-3	3	16#	103.02	154.51	262.45	479.31	695.96
INVC-755-4	4	22#	118.38	185.44	324.42	593.31	886.64
INV-754			Carbon Lot Prices				
INV-754-2	2	12#	80.53	110.81	174.52	303.23	429.45
INV-754-3	3	18#	90.69	129.52	214.97	382.94	553.08
INV-754-4	4	25#	100.75	150.07	254.99	463.63	673.13
INVCC-765			Carbonless Lot Prices				
INVCC-765-2	2	11#	86.26	120.33	195.28	343.14	498.02
INVCC-765-3	3	16#	103.02	154.51	262.45	479.31	695.96
INVCC-765-5	5	28#	133.42	214.32	381.21	701.90	1,049.21
INV-764			Carbon Lot Prices				
INV-764-3	3	18#	90.69	129.52	214.97	382.94	553.08
INV-764-4	4	25#	100.75	150.07	254.99	463.63	673.13
INV-764-5	5	31#	107.46	170.51	295.33	547.02	794.71

Envelopes available on page 100. (9907)

(R)

D **INVCC-760 - Invoice**

Cat. No.	Pts.	Wt. per 1000	Carbonless Lot Prices				
			250	500	1000	2000	3000
INVCC-760-2	2	9#	80.53	110.05	175.06	304.85	431.83
INVCC-760-3	3	13#	93.50	127.25	211.29	375.59	547.45
INVCC-760-4	4	17#	99.45	143.91	237.25	424.15	618.62

Envelopes available on page 100. (9907)

(R)

E **INVCC-767 - Invoice**

Cat. No.	Pts.	Wt. per 1000	Carbonless Lot Prices				
			250	500	1000	2000	3000
INVCC-767-3	3	16#	103.02	154.51	262.45	479.31	695.96

Envelopes available on page 100. (9907)

(R)

Bilingual

E **INVCC-767 - Snap-A-Part**
Invoice, 8½" x 7"
Imprint area 1" x 4"
Bilingual

NOTE:

! If you need an English/Spanish, Bilingual Invoice, try the **INVCC-767**.

Invoices

A **INVCC-782, INV-781 - Snap-A-Part Invoice, 8½" x 7"**
Imprint area 1" x 3"

Part 4 Packing List with blackout

Part 5 with label for INV-781

B **INVCC-759 Snap-A-Part Invoice, 8½" x 11"**
Imprint area 1" x 4"

C **INVCC-758 Snap-A-Part Invoice, 8½" x 8½"**
Imprint area 1" x 4"

D **INVCC-757 Snap-A-Part Invoice, 8½" x 7"**
Imprint area 1" x 4"

A **INVCC-782, INV-781 - Invoice**

Cat. No.	Pts.	Wt. per 1000	Carbonless Lot Prices				
			250	500	1000	2000	3000
782-4	4	22#	118.38	185.44	324.43	593.31	886.64
INV-			Carbon Lot Prices				
781-4	4	25#	100.75	150.07	254.99	463.63	673.13
781-5	5	31#	135.47	218.10	389.11	741.60	1,086.95

Envelopes available on page 100. (9911, 9909) (R)

B **INVCC-759 - Invoice**

Cat. No.	Pts.	Wt. per 1000	Carbonless Lot Prices				
			250	500	1000	2000	3000
759-3	3	25#	122.17	191.39	336.76	627.38	923.20

Envelopes available on page 100. (9907) (R)

C **INVCC-758 - Invoice**

Cat. No.	Pts.	Wt. per 1000	Carbonless Lot Prices				
			250	500	1000	2000	3000
758-3	3	20#	108.35	164.78	284.30	522.58	763.01
758-4	4	26#	126.38	200.69	358.39	667.29	979.55

Envelopes available on page 100. (9907) (R)

D **INVCC-757 - Invoice**

Cat. No.	Pts.	Wt. per 1000	Carbonless Lot Prices				
			250	500	1000	2000	3000
757-3	3	16#	103.02	154.51	262.45	479.31	695.96

Envelopes available on page 100. (9907) (R)

NOTE:



Includes your company's name, address and phone number in one of four colors! For blank forms, subtract 30% unless otherwise listed.



Colors correspond to sequence and number of parts selected in your order unless otherwise specified.



Choose a six-digit number for your imprinted form, or seven-digit for all register forms at no extra charge! Otherwise, we will start with 001001 or 0001001. Four, five and custom seven-digit numbering available at an additional charge. See page 142 for pricing.



Blank forms will be sequentially numbered unless specified otherwise.

View forms in detail at:
www.bfands.com

A STCC-679, STCC-689, ST-678, ST-688 - Statement

Cat. No.	STCC-	Pts.	Wt. per 1000	Carbonless Lot Prices				
				250	500	1000	2000	3000
679-2	Unruled	2	8#	82.69	104.64	163.70	282.35	398.73
689-2	Ruled	2	8#	82.69	104.64	163.70	282.35	398.73
689-3	Ruled	3	11#	89.39	125.20	204.69	364.23	521.93
689-4	Ruled	4	14#	95.88	145.10	244.82	444.92	614.62
689-5	Ruled	5	16#	102.27	164.46	283.00	523.60	704.72
ST-		Carbon Lot Prices						
678-2	Unruled	2	9#	80.63	103.02	150.83	252.93	352.66
688-2	Ruled	2	9#	80.63	103.02	150.83	252.93	352.66

Numbered by request only. (R)
Envelopes available on page 101. (9915)

B STCC-687, STCC-677, ST-686 - Statement

Cat. No.	STCC-	Pts.	Wt. per 1000	Carbonless Lot Prices				
				250	500	1000	2000	3000
687-2	Ruled	2	8#	82.69	104.64	163.70	282.35	398.73
677-2	Unruled	2	8#	82.69	104.64	163.70	282.35	398.73
ST-		Carbon Lot Prices						
686-2	Ruled	2	9#	80.63	103.02	150.83	252.93	352.66

Numbered by request only. (R)
Envelopes available on page 101. (9915)

NOTE:



Company Imprint

Includes your company's name, address and phone number in one of four colors! For blank forms, subtract 30% unless otherwise listed.



Starting Number

Choose a six-digit number for your imprinted form, or seven-digit for all register forms at no extra charge! Otherwise, we will start with 001001 or 0001001. Four, five and custom seven-digit numbering available at an additional charge. See page 142 for pricing.

Blank forms will be sequentially numbered unless specified otherwise.



Multi-part Color Sequence

Colors correspond to sequence and number of parts selected in your order unless otherwise specified.



Color code your collections with Collection Forms (page 79) and Business Reply Envelopes (page 99).

PRINTED WITH SOY INK

STATEMENT

YOUR COMPANY NAME
Address
CITY, STATE, ZIP CODE
Phone Number
Advertising Line

DATE

Detach and Return This Stub With Remittance. Amt. Remitted \$

DATE	CHARGES AND CREDITS	BALANCE

STCC-689-2 PRINTED IN U.S.A. Your Check is Your Receipt Thank You

A STCC-679 (Unruled), STCC-689 (Ruled), ST-678 (Unruled), ST-688 (Ruled) - Snap-A-Part Statement, 5 1/2" x 7" Imprint area 1" x 4"

PRINTED IN U.S.A. PRINTED WITH SOY INK

STATEMENT

YOUR COMPANY NAME
Address
CITY, STATE, ZIP CODE
Phone Number
Advertising Line

DATE

DETACH AND MAIL WITH YOUR CHECK. YOUR CANCELLED CHECK IS YOUR RECEIPT.

DATE	DESCRIPTION	CHARGES	CREDITS	BALANCE

Thank You PAID BY CHECK NO. ST-CC-679-2

B STCC-687 (Ruled), STCC-677 (Unruled), ST-686 (Ruled) - Snap-A-Part Statement, 5 1/2" x 7" Imprint area 1" x 4"

Laser Statements



LS-5730 - Navy
LS-5731 - Hunter Green
LS-5732 - Burgundy (shown)

Laser Statement
 Blank front and back
 8½" x 11"

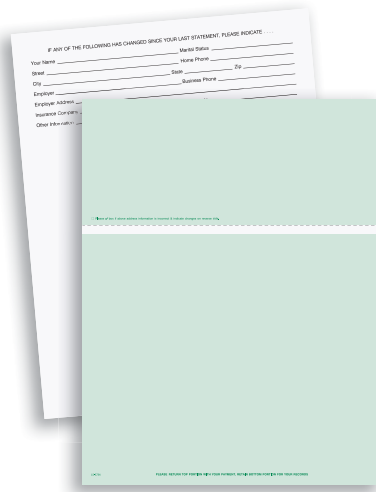

LS-5733 - Navy
LS-5734 - Hunter Green (shown)
LS-5735 - Burgundy

Laser Statement
 Change of address backer
 8½" x 11"

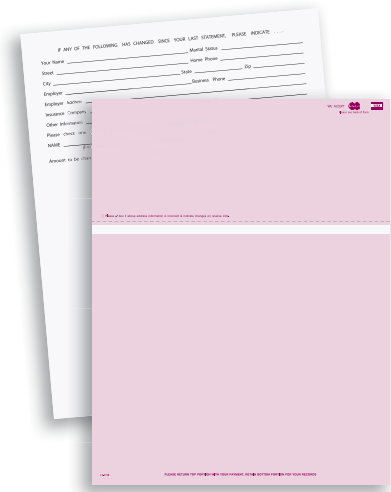

LS-5736 - Navy
LS-5737 - Hunter Green
LS-5738 - Burgundy (shown)

Laser Statement
 Mastercard & Visa on front
 Change of address & credit card info on back
 8½" x 11"

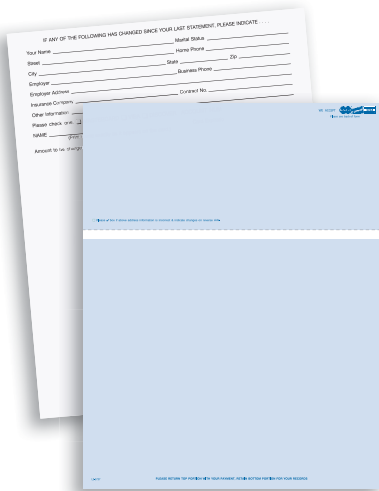

LS-5739 - Navy (shown)
LS-5740 - Hunter Green
LS-5741 - Burgundy

Laser Statement
 Mastercard, Visa & Discover
 on front
 Change of address & credit card
 info on back
 8½" x 11"

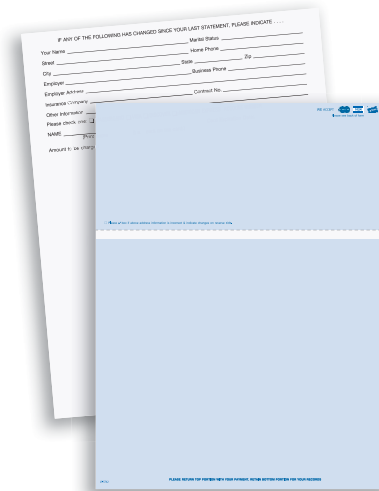

LS-5742 - Navy (shown)
LS-5743 - Hunter Green
LS-5744 - Burgundy

Laser Statement
 Mastercard, Visa, Discover &
 American Express on front
 Change of address & credit card
 info on back
 8½" x 11"

*Statements that
 work with your
 software.*

Laser Statements

Cat. No.	LS- Color	Backer	Pts.	Wt. per 1000	Blank Lot Prices				
					500	1000	2000	3000	5000
5730	Navy	No Backer	1	11#	53.27	75.87	130.06	186.31	295.33
5731	Hunter Green	No Backer	1	11#	53.27	75.87	130.06	186.31	295.33
5732	Burgundy	No Backer	1	11#	53.27	75.87	130.06	186.31	295.33
5733	Navy	Backer	1	11#	53.27	75.87	130.06	186.31	295.33
5734	Hunter Green	Backer	1	11#	53.27	75.87	130.06	186.31	295.33
5735	Burgundy	Backer	1	11#	53.27	75.87	130.06	186.31	295.33
5736	Navy	Backer	1	11#	53.27	75.87	130.06	186.31	295.33
5737	Hunter Green	Backer	1	11#	53.27	75.87	130.06	186.31	295.33
5738	Burgundy	Backer	1	11#	53.27	75.87	130.06	186.31	295.33
5739	Navy	Backer	1	11#	53.27	75.87	130.06	186.31	295.33
5740	Hunter Green	Backer	1	11#	53.27	75.87	130.06	186.31	295.33
5741	Burgundy	Backer	1	11#	53.27	75.87	130.06	186.31	295.33
5742	Navy	Backer	1	11#	53.27	75.87	130.06	186.31	295.33
5743	Hunter Green	Backer	1	11#	53.27	75.87	130.06	186.31	295.33
5744	Burgundy	Backer	1	11#	53.27	75.87	130.06	186.31	295.33

Perforation at 3⁹/₁₆" from top of form.
 Not available imprinted or numbered.
 Envelopes available on page 100. (9910)

(R)

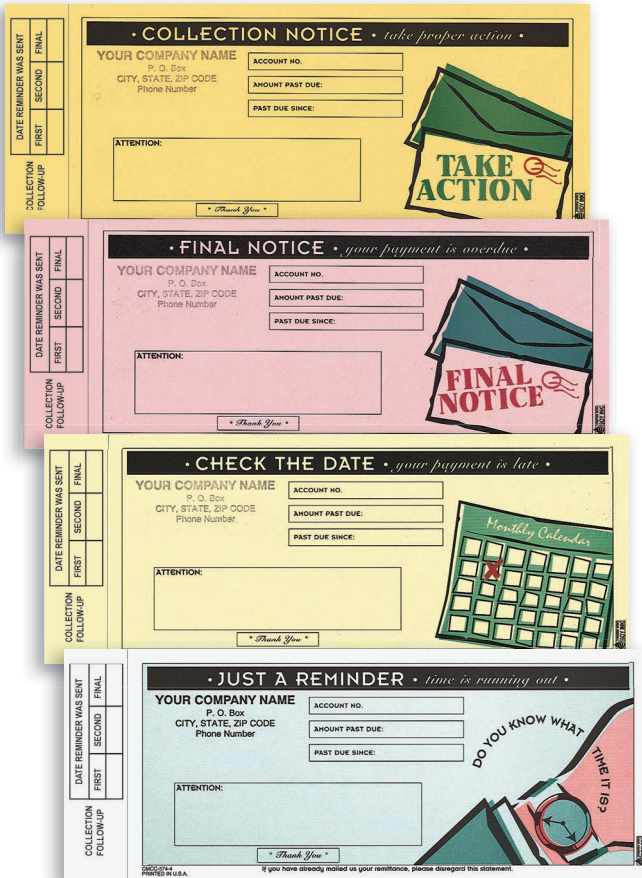

A **CMCC-574 - Snap-A-Part**
Collection Form, 8½" x 3¾"
Imprint area ⅝" x 2½"

A **CMCC-574 - Collection Form**

Cat. No.	Pts.	Wt. per 1000	Carbonless Lot Prices				
			250	500	1000	2000	3000
574-4	4	12#	81.71	129.41	225.46	404.90	584.01

Not available numbered. (R)
Envelopes available on page 100. (9909)

B **CMCC-575 - Collection Memo**

Cat. No.	Pts.	Wt. per 1000	Carbonless Lot Prices				
			250	500	1000	2000	3000
575-4	4	22#	119.68	188.47	330.59	633.87	905.03

Not available numbered. (R)
Envelopes available on page 100. (9909, 9911)

NOTE:



Includes your company's name, address and phone number in one of four colors! For blank forms, subtract 30% unless otherwise listed.



Colors correspond to sequence and number of parts selected in your order unless otherwise specified.



! **Business Reply Envelopes, available in colors to match each consecutive message. See page 99.**

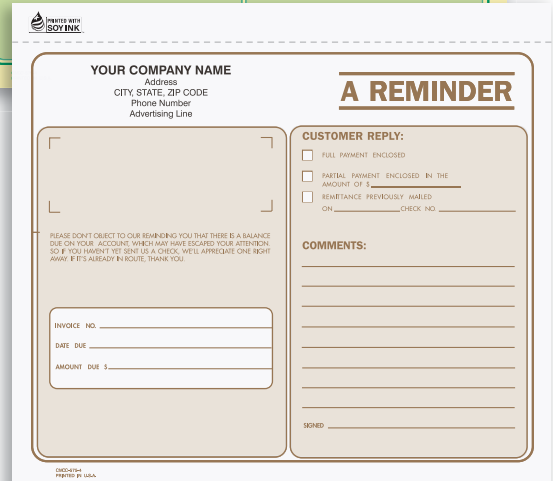

B **CMCC-575 - Snap-A-Part**
Collection Memo, 8½" x 7"
Imprint area 1" x 4"

Credit/Debit Memos

PRINTED IN U.S.A.

YOUR COMPANY NAME
Address
CITY, STATE, ZIP CODE
Phone Number
Advertising Line

DEBIT MEMO
001001

SHIPPED TO

QTY	MEMO DATE	YOUR ORDER NO.	INVOICE DATE	YOUR INVOICE NO.	ITEMS	QTY	DATE RETURNED	RETURNED QTY
QUANTITY	DESCRIPTION			PRICE	AMOUNT			

REASON FOR CREDIT: _____ AUTHORIZED SIGNATURE: _____

WE DEBIT YOUR ACCOUNT AS SHOWN

A DM-577 - Snap-A-Part
Debit Memo, 8½" x 7"
Imprint area 1" x 4"

PRINTED IN U.S.A.

YOUR COMPANY NAME
Address
CITY, STATE, ZIP CODE
Phone Number
Advertising Line

DEBIT / CREDIT MEMO
 DEBIT CREDIT 001001

TO: _____

DATE: _____

WE HAVE MADE THE FOLLOWING ADJUSTMENT(S) TO YOUR ACCOUNT:

QUANTITY	DESCRIPTION	UNIT PRICE	TOTAL

OTHER ADJUSTMENTS: _____

PLEASE DEDUCT FROM: OUR (DEBIT) YOUR (CREDIT) BALANCE DUE. THIS TOTAL AMOUNT: _____

REASON FOR CREDIT: _____ AUTHORIZED SIGNATURE: _____

WE DEBIT YOUR ACCOUNT AS SHOWN

B DCM-578 - Snap-A-Part
Debit/Credit Memo, 8½" x 7"
Imprint area 1" x 4"

PRINTED IN U.S.A.

YOUR COMPANY NAME
Address
CITY, STATE, ZIP CODE
Phone Number
Advertising Line

CREDIT MEMO
001001

Date: _____
Submission: _____
Credit Memo No.: _____

Address to Invoice To: _____ City: _____ Customer's Order No.: _____

QUANTITY	NUMBER	DESCRIPTION	PRICE	AMOUNT
WE CREDIT YOUR ACCOUNT				

CREDIT MEMORANDUM

REASON CREDIT ISSUED: _____ RECEIVED BY: _____
CREDIT AUTHORIZED BY: _____

WE CREDIT YOUR ACCOUNT AS SHOWN

C CMCC-576, CM-579 - Snap-A-Part
Credit Memo, 8½" x 7"
Imprint area 1" x 4"

YOUR COMPANY NAME
Address
CITY, STATE, ZIP CODE
Phone Number
Advertising Line

Customer's Order No. _____ Phone No. _____ Date: _____

Name: _____

Address: _____

QTY	DATE	QTY	DATE	QTY	DATE	TOTAL
QTY	DATE	QTY	DATE	QTY	DATE	AMOUNT

TAX: _____ TOTAL: _____

0001001

PRINTED IN U.S.A.

D CM-235 - Register Form
Credit Memo, 4" x 6½"
Imprint area 1" x 3½"

A DM-577 - Debit Memo

Cat. No.	Pts.	Wt. per 1000	Carbonless Lot Prices				
			250	500	1000	2000	3000
DM-577-3	3	16#	103.02	154.51	262.45	479.31	695.96

Envelopes available on page 100. (9906, 9907) (R)

B DCM-578 - Debit/Credit Memo

Cat. No.	Pts.	Wt. per 1000	Carbonless Lot Prices				
			250	500	1000	2000	3000
DCM-578-3	3	16#	103.02	154.51	262.45	479.31	695.96

Envelopes available on page 100. (9906, 9907) (R)

C CMCC-576, CM-579 - Credit Memo

Cat. No.	Pts.	Wt. per 1000	Carbonless Lot Prices				
			250	500	1000	2000	3000
CMCC-576-3	3	16#	103.02	154.51	262.45	479.31	695.96
CM-579-3	3	18#	Carbon Lot Prices				
			90.69	129.52	214.97	382.94	553.08

All parts pink. Envelopes available on pages 100. (9909, 9911) (R)

D CM-235 - Credit Memo

Cat. No.	Pts.	Wt. per 1000	Carbonless Lot Prices				
			250	500	1000	2000	3000
CM-235-2	2	5#	71.60	92.61	125.58	192.97	259.43
CM-235-3	3	7#	81.17	104.78	149.29	240.60	332.54

7 digit numbering only. (R)

NOTE:



Includes your company's name, address and phone number in one of four colors! For blank forms, subtract 30% unless otherwise listed.



Choose a six-digit starting number for your imprinted form at no extra charge! Otherwise, we will start with 001001. Four, five and seven-digit numbering available at an additional charge. See page 142 for pricing.



Colors correspond to sequence and number of parts selected in your order unless otherwise specified.

Blank forms will be sequentially numbered unless specified otherwise.

A **RMCC-848, RM-858 - Snap-A-Part**
Reply Memo Ruled, 8½" x 7"
Imprint area ¾" x 3½"

B **RMCC-868 - Snap-A-Part**
Reply Memo Unruled, 8½" x 6½"
Imprint area ¾" x 3½"

A **RMCC-848, RM-858 Ruled - Reply Memo**

Cat. No.	Pts.	Wt. per 1000	Carbonless Lot Prices				
			250	500	1000	2000	3000
848-2	2	11#	86.26	120.33	195.28	343.14	498.02
848-3	3	16#	103.02	154.51	262.45	479.31	695.96
RM-			Carbon Lot Prices				
858-3	3	18#	90.69	129.52	214.97	382.94	553.08

Envelopes available on page 100. (9906)

(R)

B **RMCC-868, Unruled - Reply Memo**

Cat. No.	Pts.	Wt. per 1000	Carbonless Lot Prices				
			250	500	1000	2000	3000
868-3	3	16#	103.02	154.51	262.45	479.31	695.96

Envelopes available on page 100. (9906)

(R)

C **MRM-810 - Message/ Reply Memo**

Cat. No.	Pts.	Wt. per 1000	Carbonless Lot Prices				
			250	500	1000	2000	3000
810-3	3	16#	103.02	154.51	262.45	479.31	695.96

Envelopes available on page 100. (9909, 9911)

(R)

D **MRM-859 - Message/ Reply Memo**

Cat. No.	Pts.	Wt. per 1000	Carbon Lot Prices				
			250	500	1000	2000	3000
859-3	3	18#	95.99	129.09	213.24	379.91	550.48

Envelopes available on page 100. (9906)

(R)

NOTE:



! Self-Inking Stamps make your job easier. See page 122

C **MRM-810 - Snap-A-Part**
Message/Reply Memo, 8½" x 6½"
Imprint area ¾" x 3½"

D **MRM-859 - Snap-A-Part**
Message/Reply Memo, 8½" x 6½"
Imprint area ⅞" x 3"

A MLCC-800 - Snap-A-Part
Memo Letter, 8½" x 7¾"
Imprint area 1" x 4"

B MLCC-803 - Snap-A-Part
Memo Letter, 8½" x 7¾"
Imprint area 1" x 4"

C MLCC-802 - Snap-A-Part
Memo Letter, 8½" x 7¾"
Imprint area 1" x 4"

D PM-101 - Wire Bound Book
Phone Memo Book
Each message measures 5¼" x 2¾", 5¼" x 8¼" Overall
150 Messages Per Book

A MLCC-800 - Memo Letter

Cat. No.	Pts.	Wt. per 1000	250	Carbonless Lot Prices			
MLCC-			500	1000	2000	3000	
800-2	2	12#	89.50	130.39	208.05	370.50	530.69

Envelopes available on page 100. (9910, 9911) (R)

B MLCC-803 - Memo Letter

Cat. No.	Pts.	Wt. per 1000	250	Carbonless Lot Prices			
MLCC-			500	1000	2000	3000	
803-2	2	12#	89.50	130.39	208.05	370.50	530.69
803-3	3	17#	103.02	154.51	262.45	479.31	695.96

Envelopes available on page 100. (9910, 9911) (R)

C MLCC-802 - Memo Letter

Cat. No.	Pts.	Wt. per 1000	250	Carbonless Lot Prices			
MLCC-			500	1000	2000	3000	
802-2	2	12#	89.50	130.39	208.05	370.50	530.69

Envelopes available on page 100. (9909, 9911) (R)

D PM-101 - Phone Memo Book

Cat. No.	Pts.	Wt. per 5 Bks	5 Bks	Carbonless Lot Prices			
PM-			10 Bks	15 Bks	25 Bks	50 Bks	
101-2	2	4#	61.49	107.02	144.66	239.09	473.25

Not available imprinted. (R)

NOTE:



Includes your company's name, address and phone number in one of four colors! For blank forms, subtract 30% unless otherwise listed.



Colors correspond to sequence and number of parts selected in your order unless otherwise specified.

Keep your business rolling!

- Premium quality, guaranteed to work efficiently!
- BPA Free and a color coded end of roll for alerting your customers.
- All rolls on 7/16" core.



Thermal Rolls						
Cat. No.	Description	Rolls per Pkg	Size	Wt. per Pkg	Price per Roll	Price per Pkg
PR-0023	Paper Roll, 2 Part, NCR	10/Pkg	3" x 90'	5#	1.59/Roll	15.91
BPR-0024	Bond Paper Roll	12/Pkg	2 1/4" x 120'	3#	.70/Roll	8.36
TPR-0026	Thermal Paper Roll	8/Pkg	3 1/8" x 240'	5#	2.43/Roll	19.47
TPR-0027	Thermal Paper Roll	12/Pkg	2 1/4" x 55'	2#	.70/Roll	8.36
TPR-0028	Thermal Paper Roll	12/Pkg	2 1/4" x 85'	2#	.86/Roll	10.36

(R)

**Additional sizes available,
please call!**

Creative Designs at a Great Price!

It's easier than ever to design your checks with our pre-designed checks and vouchers.

STEP 1: Choose from three convenient check formats: Traditional, Personal and Conventional.

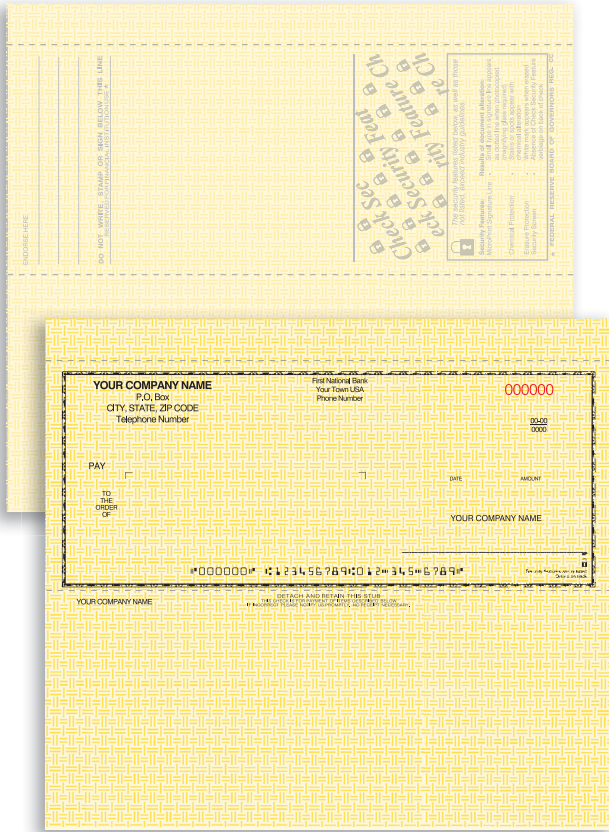

A Check Style 1 - Traditional
8 1/2" x 7"

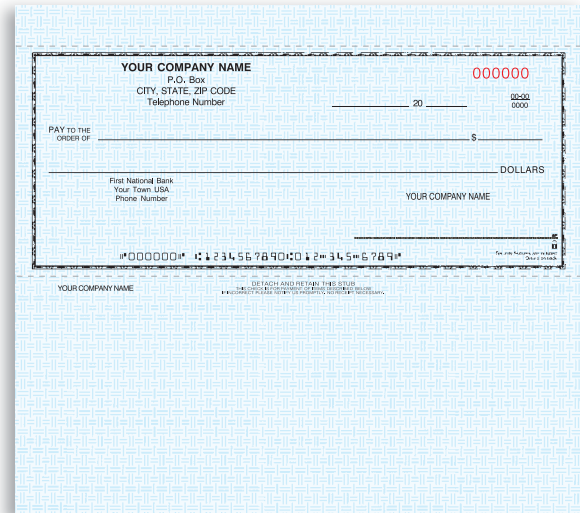

B Check Style 2 - Personal
8 1/2" x 7"

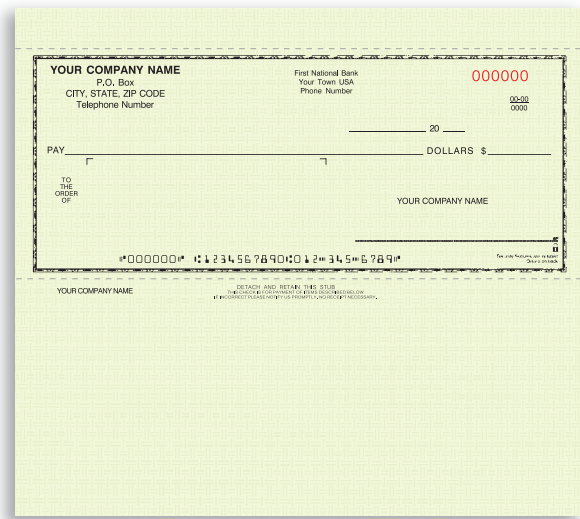

C Check Style 3 - Conventional
8 1/2" x 7"

Parts 2 and 3 are pre-punched on left, making storage of copies convenient.

A Style 1 - Traditional Style Check

Description	Pts.	Wt. per 1000	Carbonless Lot Prices				
			250	500	1000	2000	3000
Check/Voucher	2	15#	113.19	181.22	311.45	574.28	843.92
Check/Voucher	3	21#	130.06	214.97	378.83	708.50	1,045.96

Envelopes available on page 100. (9908) (R)

B Style 2 - Personal Style Check

Description	Pts.	Wt. per 1000	Carbonless Lot Prices				
			250	500	1000	2000	3000
Check/Voucher	2	15#	113.19	181.22	311.45	574.28	843.92
Check/Voucher	3	21#	130.06	214.97	378.83	708.50	1,045.96

Envelopes available on page 100. (9908) (R)

C Style 3 - Conventional Style Check

Description	Pts.	Wt. per 1000	Carbonless Lot Prices				
			250	500	1000	2000	3000
Check/Voucher	2	15#	113.19	181.22	311.45	574.28	843.92
Check/Voucher	3	21#	130.06	214.97	378.83	708.50	1,045.96

Envelopes available on page 100. (9908) (R)

STEP 2: Choose from one of four voucher styles:

- **General or General 2** - Great for applications that require maximum space.
- **Dual Purpose** - Designed for recording payroll or general disbursements.
- **Blank** - Useful when the purpose of the voucher varies.

STEP 3: Choose paper and ink colors.

STEP 4: Choose up to three carbonless parts. All copies are consecutively numbered and “Not Negotiable” is always printed on copies for optimum safety.

A Voucher Style 1 - General Purpose

B Voucher Style 2 - General 2

C Voucher Style 3 - Dual Purpose

D Voucher Style 4 - Blank

NOTE:

Safety Paper Colors



When Ordering Checks

Be sure to send a voided check or bank specification sheet to ensure correct MICR encoding.



Check Numbering
Starting Number: Choose a six-digit starting number for your imprinted form at no extra charge! Otherwise, we will start with 001001. Four, five and seven-digit numbering available at an additional charge. See page 142 for pricing.

Blank forms will be sequentially numbered unless specified otherwise.



Company Imprint
Includes your company's name, address and phone number in one of four colors! For blank forms, subtract 30% unless otherwise listed.



Multi-part Color Sequence
Colors correspond to sequence and number of parts selected in your order unless otherwise specified.



Photocopy and write your present check MICR number in the boxes below or use your bank specification sheet.

43	42	41	40	39	38	37	36	35	34	33	32	31	30	29	28	27	26	25	24	23	22	21	20	19	18	17	16	15	14	13
----	----	----	----	----	----	----	----	----	----	----	----	----	----	----	----	----	----	----	----	----	----	----	----	----	----	----	----	----	----	----

Please note: Any numbers to the left of the numbers within the symbols are not needed to process your order.

A = B = Blank

Create Your Own Design!

STEP 1: Make your paper selection.

STEP 2: Specify color, parts and quantity.

STEP 1: Send us your custom check design.

Full Body Crash Printed!

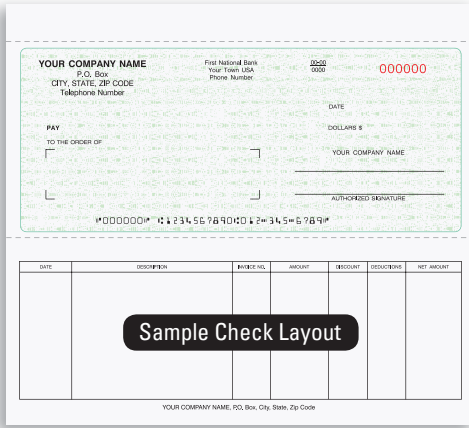

Sample Check Layout

A DFCC - Snap-A-Part Custom Check, 8½" x 7"

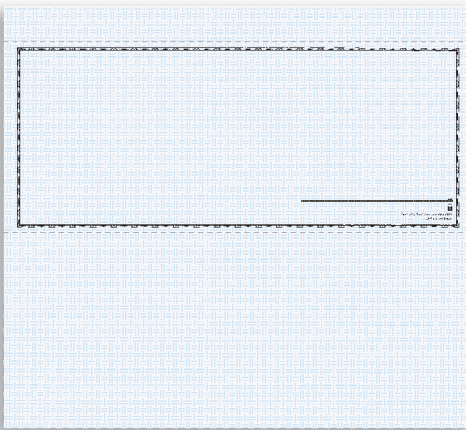

B SFCC - Snap-A-Part Custom Check, 8½" x 7"

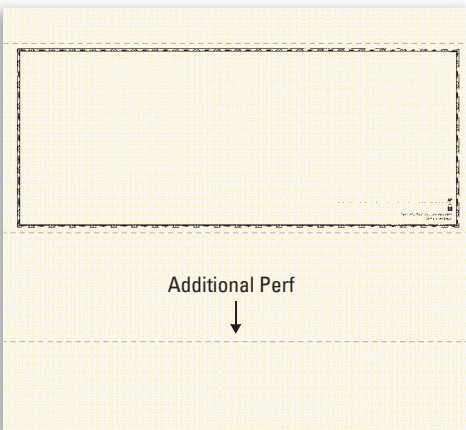

C SFCC - Snap-A-Part Voucher Check, 8½" x 7"

A DFCC - Custom Check

Cat. No. DFCC-	Color	Pts.	Wt. per 1000	Carbonless Lot Prices				
				250	500	1000	2000	3000
840-2	Blue	2	15#	142.72	222.54	376.99	688.17	1,006.37
840-3	Blue	3	21#	152.88	245.58	425.66	787.68	1,156.50
841-2	Brown	2	15#	142.72	222.54	376.99	688.17	1,006.37
841-3	Brown	3	21#	152.88	245.58	425.66	787.68	1,156.50
842-2	Green	2	15#	142.72	222.54	376.99	688.17	1,006.37
842-3	Green	3	21#	152.88	245.58	425.66	787.68	1,156.50
843-2	Gray	2	15#	142.72	222.54	376.99	688.17	1,006.37
843-3	Gray	3	21#	152.88	245.58	425.66	787.68	1,156.50

Envelopes available on page 100. (9908)

(R)

B SFCC - Custom Check

Cat. No. SFCC-	Color	Pts.	Wt. per 1000	Carbonless Lot Prices				
				250	500	1000	2000	3000
740-2	Blue	2	15#	142.72	222.54	376.99	688.17	1,006.37
740-3	Blue	3	21#	152.88	245.58	425.66	787.68	1,156.50
741-2	Buff	2	15#	142.72	222.54	376.99	688.17	1,006.37
741-3	Buff	3	21#	152.88	245.58	425.66	787.68	1,156.50
742-2	Green	2	15#	142.72	222.54	376.99	688.17	1,006.37
742-3	Green	3	21#	152.88	245.58	425.66	787.68	1,156.50

Envelopes available on page 100. (9908)

(R)

C SFCC - Voucher Check

Cat. No. SFCC-	Color	Pts.	Wt. per 1000	Carbonless Lot Prices				
				250	500	1000	2000	3000
745-3	Blue	3	21#	152.88	245.58	425.66	787.68	1,156.50
746-2	Buff	2	15#	142.72	222.54	376.99	688.17	1,006.37
746-3	Buff	3	21#	152.88	245.58	425.66	787.68	1,156.50
747-2	Green	2	15#	142.72	222.54	376.99	688.17	1,006.37
747-3	Green	3	21#	152.88	245.58	425.66	787.68	1,156.50

Envelopes available on page 100. (9908)

(R)

NOTE:

Screened Background Colors (Item A)

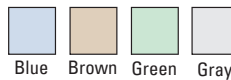

Safety Paper Colors (Items B & C)

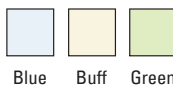

Security Features (Items B & C)

- Padlock Warning Box lists details of features.
- Defensa[®] paper with a true watermark allows anyone to verify the check's authenticity.
- Intricate background provides erasure protection.
- Microprint border and signature line are readable under simple magnification and become a solid line when photocopied or scanned.

Blank checks will not be sequentially numbered unless otherwise specified. Be sure to send a voided check or bank specification sheet to insure correct MICR encoding.

A SCCC - Accounts Payable Security Check

Cat. No. SCCC-	Color	Pts.	Wt. per 1000	Carbonless Lot Prices				
				250	500	1000	2000	3000
Screened Background Colors								
380-2	Blue	2	15#	118.81	191.39	260.72	492.72	724.94
380-3	Blue	3	21#	136.55	225.78	387.92	608.24	839.27
381-2	Red	2	15#	118.81	191.39	260.72	492.72	724.94
381-3	Red	3	21#	136.55	225.78	387.92	608.24	839.27
382-2	Green	2	15#	118.81	191.39	260.72	492.72	724.94
382-3	Green	3	21#	136.55	225.78	387.92	608.24	839.27
383-2	Brown	2	15#	118.81	191.39	260.72	492.72	724.94
383-3	Brown	3	21#	136.55	225.78	387.92	608.24	839.27
384-2	Gray	2	15#	118.81	191.39	260.72	492.72	724.94
384-3	Gray	3	21#	136.55	225.78	387.92	608.24	839.27
Marble Background Colors								
480-2	Blue	2	15#	118.81	191.39	260.72	492.72	724.94
480-3	Blue	3	21#	136.55	225.78	387.92	608.24	839.27
481-2	Red	2	15#	118.81	191.39	260.72	492.72	724.94
481-3	Red	3	21#	136.55	225.78	387.92	608.24	839.27
482-2	Green	2	15#	118.81	191.39	260.72	492.72	724.94
482-3	Green	3	21#	136.55	225.78	387.92	608.24	839.27
483-3	Brown	3	21#	136.55	225.78	387.92	608.24	839.27
484-3	Gray	3	21#	136.55	225.78	387.92	608.24	839.27

Parts 2 and 3 are punched on left. (R)
Envelopes available on page 100. (9908)

B DCCC - Dual Purpose Security Check

Cat. No. DCCC-	Color	Pts.	Wt. per 1000	Carbonless Lot Prices				
				250	500	1000	2000	3000
Screened Background Colors								
390-2	Blue	2	15#	118.81	191.39	260.72	492.72	724.94
390-3	Blue	3	21#	136.55	225.78	387.92	608.24	839.27
392-2	Green	2	15#	118.81	191.39	260.72	492.72	724.94
392-3	Green	3	21#	136.55	225.78	387.92	608.24	839.27
393-3	Brown	3	21#	136.55	225.78	387.92	608.24	839.27
394-2	Gray	2	15#	118.81	191.39	260.72	492.72	724.94
394-3	Gray	3	21#	136.55	225.78	387.92	608.24	839.27
Marble Background Colors								
470-2	Blue	2	15#	118.81	191.39	260.72	492.72	724.94
470-3	Blue	3	21#	136.55	225.78	387.92	608.24	839.27
472-2	Green	2	15#	118.81	191.39	260.72	492.72	724.94
472-3	Green	3	21#	136.55	225.78	387.92	608.24	839.27
473-2	Brown	2	15#	118.81	191.39	260.72	492.72	724.94

Parts 2 and 3 are punched on left. (R)
Envelopes available on page 100. (9908)

NOTE:



Company Imprint

Includes your company's name, address and phone number in one of four colors! For blank forms, subtract 30% unless otherwise listed.



Check Numbering

Starting Number: Choose a six-digit starting number for your imprinted check at no additional charge. Otherwise, we will start at 001001. Four, five and seven-digit numbering is available at an additional charge. See page 142 for pricing.

Blank checks will not be sequentially numbered unless otherwise specified.



Multi-part Color Sequence

Colors correspond to sequence and number of parts selected in your order unless otherwise specified.



3 Day Shipping

SECURITY

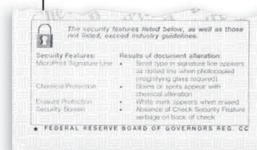

Items A & B include a Padlock Warning Box, which lists details of security features.



Microprint border and signature line are readable under simple magnification. On copies, microprinting is virtually unreadable. Signature line becomes a broken line when altered (Available on Security Checks only).

DATE	DESCRIPTION	BUCKS	HAL	AMOUNT	DROUGHT	DEDUCTIONS	NET AMOUNT

A SCCC - Snap-A-Part

Accounts Payable Security Check, 8½" x 7"
Imprint area ¾" x 4"

DATE	DESCRIPTION	BUCKS	HAL	AMOUNT	DROUGHT	DEDUCTIONS	NET AMOUNT

B DCCC - Snap-A-Part

Dual Purpose Security Check, 8½" x 7"
Imprint area ¾" x 4"

A SCCC, SC - Snap-A-Part
Accounts Payable Check, 8½" x 7"
Imprint area ¾" x 4"

B DCB, DCG - Snap-A-Part
Dual Purpose Voucher Check, 8½" x 7"
Imprint area ¾" x 4"

C DCCC, DC - Snap-A-Part
Dual Purpose Check, 8½" x 7"
Imprint area ¾" x 4"

A SCCC, SC - Accounts Payable Check

Cat. No.	Color	Pts.	Wt. per 1000	Carbonless Lot Prices				
				250	500	1000	2000	3000
627-2	Blue	2	15#	113.19	182.84	306.80	469.58	690.87
627-3	Blue	3	21#	130.17	215.18	369.65	579.68	853.00
619-2	Red	2	15#	113.19	182.84	306.80	469.58	690.87
619-3	Red	3	21#	130.17	215.18	369.65	579.68	853.00
617-2	Green	2	15#	113.19	182.84	306.80	469.58	690.87
617-3	Green	3	21#	130.17	215.18	369.65	579.68	853.00
616-2	Brown	2	15#	113.19	182.84	306.80	469.58	690.87
616-3	Brown	3	21#	130.17	215.18	369.65	579.68	853.00
618-2	Gray	2	15#	113.19	182.84	306.80	469.58	690.87
618-3	Gray	3	21#	130.17	215.18	369.65	579.68	853.00

Cat. No.	Color	Pts.	Wt. per 1000	Carbon Lot Prices				
				250	500	1000	2000	3000
607-3	Blue	3	23#	122.82	200.15	354.28	660.26	971.44
609-3	Red	3	23#	122.82	200.15	354.28	660.26	971.44
611-3	Brown	3	23#	122.82	200.15	354.28	660.26	971.44
614-3	Green	3	23#	122.82	200.15	354.28	660.26	971.44
608-3	Gray	3	23#	122.82	200.15	354.28	660.26	971.44

Parts 2 and 3 are punched on left. (R)
Envelopes available on page 100. (9908)

B DCB, DCG - Dual Purpose Voucher Check

Cat. No.	Color	Pts.	Wt. per 1000	Carbon Lot Prices				
				250	500	1000	2000	3000
612-3	Blue	3	23#	124.44	204.26	360.12	677.89	998.26

Cat. No.	Color	Pts.	Wt. per 1000	Carbon Lot Prices				
				250	500	1000	2000	3000
613-3	Gold	3	23#	124.44	204.26	360.12	677.89	998.26

Parts 2 and 3 are punched on left. (R)
Envelopes available on page 100. (9908)

C DCCC, DC - Dual Purpose Check

Cat. No.	Color	Pts.	Wt. per 1000	Carbonless Lot Prices				
				250	500	1000	2000	3000
615-2	Blue	2	15#	113.19	182.84	306.80	469.58	690.87
615-3	Blue	3	21#	130.17	215.18	369.65	579.68	853.00
622-2	Red	2	15#	113.19	182.84	306.80	469.58	690.87
622-3	Red	3	21#	130.17	215.18	369.65	579.68	853.00
626-2	Green	2	15#	113.19	182.84	306.80	469.58	690.87
626-3	Green	3	21#	130.17	215.18	369.65	579.68	853.00
623-2	Brown	2	15#	113.19	182.84	306.80	469.58	690.87
623-3	Brown	3	21#	130.17	215.18	369.65	579.68	853.00
628-3	Gray	3	21#	130.17	215.18	369.65	579.68	853.00

Cat. No.	Color	Pts.	Wt. per 1000	Carbon Lot Prices				
				250	500	1000	2000	3000
610-3	Blue	3	23#	122.82	200.15	354.28	660.26	971.44

Parts 2 and 3 are punched on left. (R)
Envelopes available on page 100. (9908)

NOTE:

When Ordering Checks

Be sure to send a voided check or bank specification sheet to ensure correct MICR encoding.

Marble or Screened Background Colors

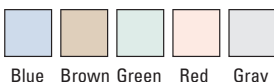

Check Numbering
Starting Number: Choose a six-digit starting number for your imprinted form at no extra charge! Otherwise, we will start with 001001. Four, five and seven-digit numbering available at an additional charge. See page 142 for pricing.

Blank forms will be sequentially numbered unless specified otherwise.



Company Imprint
Includes your company's name, address and phone number in one of four colors! For blank forms, subtract 30% unless otherwise listed.



Multi-part Color Sequence
Colors correspond to sequence and number of parts selected in your order unless otherwise specified.



D DFC-144, 145, 121, 122, 123 - General Expense Checks

Cat. No.	Color	Pts.	Wt. per 2 Bks	Carbonless Lot Prices		
				1(300)	2(600)	3(900)
144-1	Green	1	3#	65.60	109.40	160.78
145-1	Blue	1	3#	65.60	109.40	160.78
121-1	Yellow	1	3#	65.60	109.40	160.78
122-1	Brown	1	3#	65.60	109.40	160.78
123-1	Red	1	3#	65.60	109.40	160.78
DFC-				2(300)	4(600)	6(900)
144-2	Green	2	6#	134.82	239.20	337.84
145-2	Blue	2	6#	134.82	239.20	337.84
121-2	Yellow	2	6#	134.82	239.20	337.84
122-2	Brown	2	6#	134.82	239.20	337.84
123-2	Red	2	6#	134.82	239.20	337.84

Available in black ink only. (R)
Envelopes available on page 100. (9910)

E DFC-147, 148, 125, 126, 127 - Payroll Checks

Cat. No.	Color	Pts.	Wt. per 2 Bks	Carbonless Lot Prices		
				1(300)	2(600)	3(900)
147-1	Green	1	3#	65.60	109.40	160.78
148-1	Blue	1	3#	65.60	109.40	160.78
125-1	Yellow	1	3#	65.60	109.40	160.78
126-1	Brown	1	3#	65.60	109.40	160.78
127-1	Red	1	3#	65.60	109.40	160.78
DFC-				2(300)	4(600)	6(900)
147-2	Green	2	6#	134.82	239.20	337.84
148-2	Blue	2	6#	134.82	239.20	337.84
125-2	Yellow	2	6#	134.82	239.20	337.84

Available in black ink only. (R)
Envelopes available on page 100. (9910)

NOTE:

When Ordering Checks

Be sure to send a voided check or bank specification sheet to ensure correct MICR encoding.

Screened Background Colors



Blue Brown Green Red Yellow



Check Numbering
Starting Number: Choose a six-digit starting number for your imprinted form at no extra charge! Otherwise, we will start with 001001. Four, five and seven-digit numbering available at an additional charge. See page 142 for pricing.

Blank forms will be sequentially numbered unless specified otherwise.



Colors correspond to sequence and number of parts selected in your order unless otherwise specified.

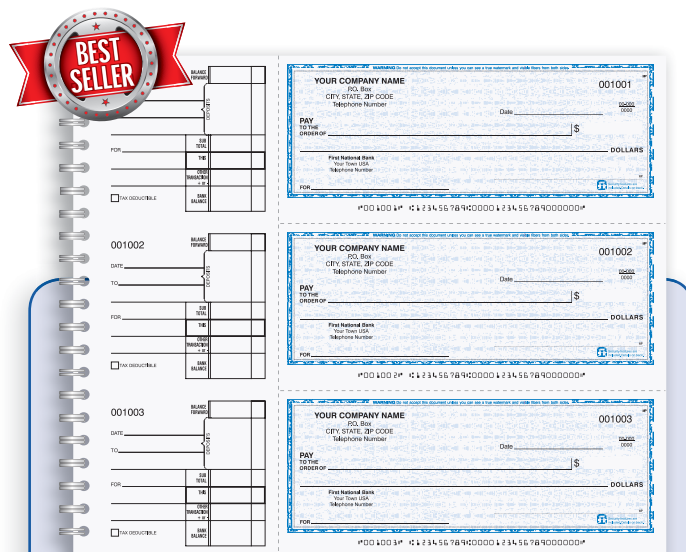

D DFC-144, 145, 121, 122, 123 - Wire Bound

General Expense Checks, 8 1/2" x 3 3/8"
13" x 11" Overall
2-Part - 150 Checks/50 Sheet Sets
1-Part - 300 Checks/100 Sheets

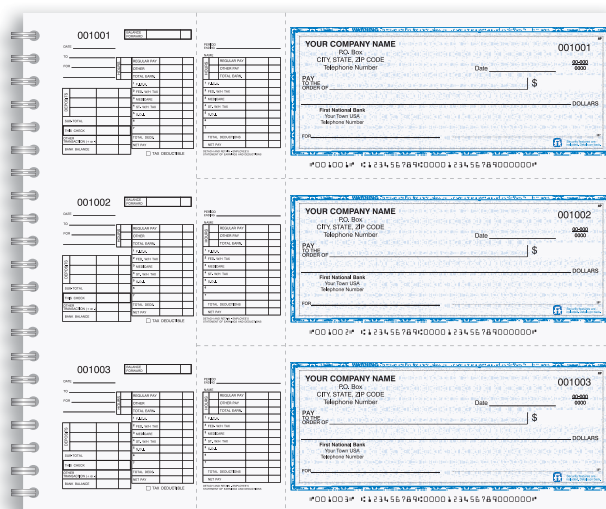

E DFC-147, 148, 125, 126, 127 - Wire Bound

Payroll Checks, 7 1/4" x 3 3/8"
13" x 11" Overall
2-Part - 150 Checks/50 Sheet Sets
1-Part - 300 Checks/100 Sheets

Photocopy and write your present check MICR number in the boxes below or use your bank specification sheet.

43	42	41	40	39	38	37	36	35	34	33	32	31	30	29	28	27	26	25	24	23	22	21	20	19	18	17	16	15	14	13
----	----	----	----	----	----	----	----	----	----	----	----	----	----	----	----	----	----	----	----	----	----	----	----	----	----	----	----	----	----	----

Please note: Any numbers to the left of the numbers within the symbols are not needed to process your order.

A = B = Blank

Smaller Size

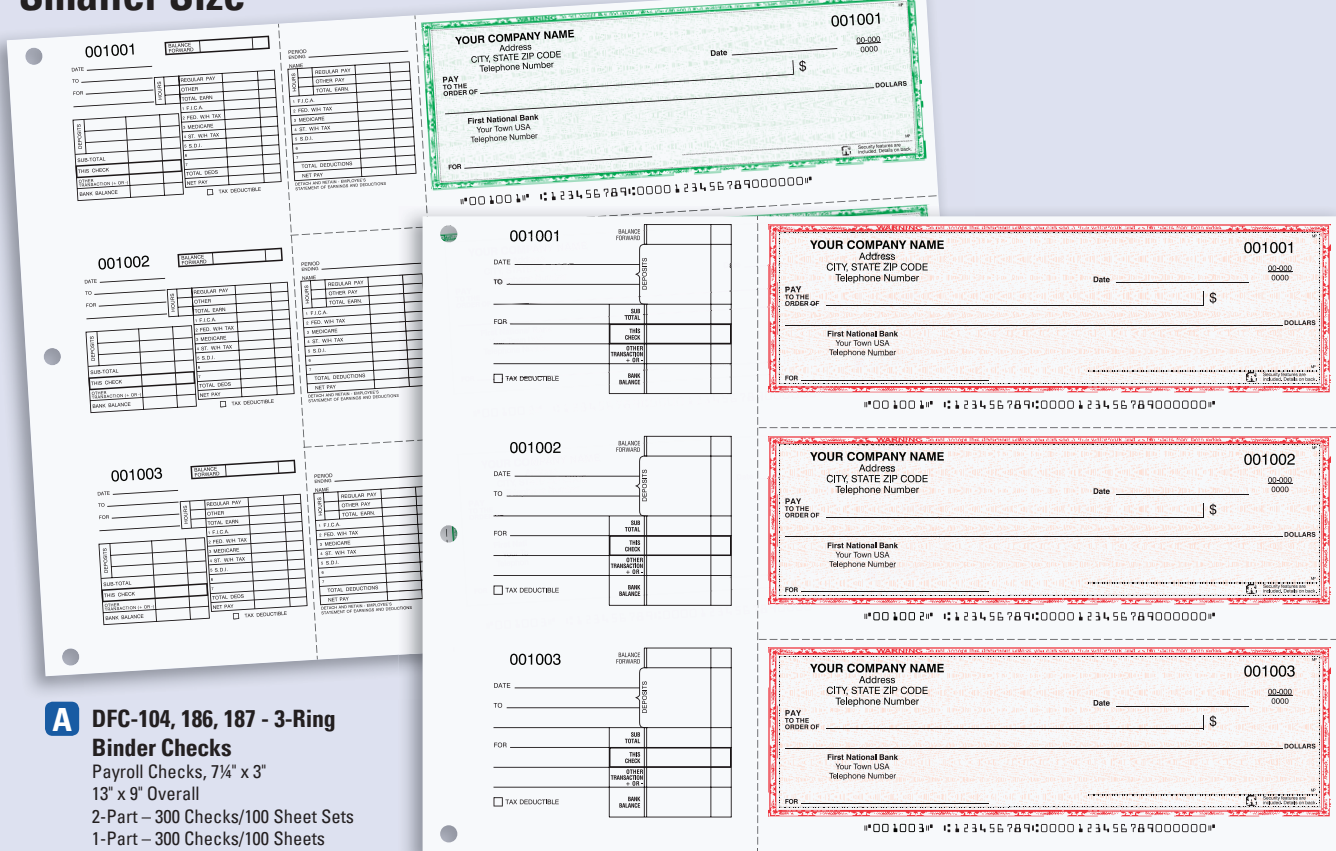

A DFC-104, 186, 187 - 3-Ring Binder Checks
Payroll Checks, 7¼" x 3"
 13" x 9" Overall
 2-Part – 300 Checks/100 Sheet Sets
 1-Part – 300 Checks/100 Sheets

B DFC-054, 046, 045 - 3-Ring Binder Checks
General Expense Checks, 8¼" x 3"
 13" x 9" Overall
 2-Part – 300 Checks/100 Sheet Sets
 1-Part – 300 Checks/100 Sheets

Convenience for Office or Away

New print technology now provides improved print quality. Choose from selections on pages 90 and 91:

- Two General Expense formats (8¼" x 3" or 8½" x 3⅔"), which contain a large stub area for ease in recording your payment details.
- The more compact Payroll/General Expense formats (7¼" x 3" or 7⅞" x 3⅔"), which include one or two stubs for easy record keeping.

Every check order includes 45 free deposit slips.

A second microprint signature line is available upon request.

A DFC-104, 186, 187 - Payroll Checks

Cat. No.	DFC- Color	Pts.	Wt. per 300	Lot Prices		
				300	600	900
104-1	Green	1	3#	56.95	96.64	141.74
186-1	Blue	1	3#	56.95	96.64	141.74
187-1	Red	1	3#	56.95	96.64	141.74
DFC-				Carbonless Lot Prices		
104-2	Green	2	6#	117.52	212.48	299.87
186-2	Blue	2	6#	117.52	212.48	299.87
187-2	Red	2	6#	117.52	212.48	299.87

Available in black ink only. (R)
 Envelopes available on page 100. (9906)

B DFC-054, 046, 045 - General Expense Checks

Cat. No.	DFC- Color	Pts.	Wt. per 300	Lot Prices		
				300	600	900
054-1	Green	1	3#	56.95	96.64	141.74
046-1	Blue	1	3#	56.95	96.64	141.74
045-1	Red	1	3#	56.95	96.64	141.74
DFC-				Carbonless Lot Prices		
054-2	Green	2	6#	117.52	212.48	299.87
046-2	Blue	2	6#	117.52	212.48	299.87
045-2	Red	2	6#	117.52	212.48	299.87

Available in black ink only. (R)
 Envelopes available on page 100. (9906)

C DFC-142, 143, 136, 137, 174, 175, 176 - General Expense Checks

Cat. No. DFC-	Color	Pts.	Wt. per 300	Lot Prices		
				300	600	900
142-1	Green	1	3#	56.95	96.64	141.74
143-1	Blue	1	3#	56.95	96.64	141.74
174-1	Yellow	1	3#	56.95	96.64	141.74
175-1	Brown	1	3#	56.95	96.64	141.74
176-1	Red	1	3#	56.95	96.64	141.74
DFC-				Carbonless Lot Prices		
136-2	Green	2	6#	117.52	212.48	299.87
137-2	Blue	2	6#	117.52	212.48	299.87
174-2	Yellow	2	6#	117.52	212.48	299.87
175-2	Brown	2	6#	117.52	212.48	299.87
176-2	Red	2	6#	117.52	212.48	299.87

Available in black ink only. (R)
Envelopes available on page 100. (9910)

D DFC-138, 139, 134, 135, 182, 183, 184 - Payroll Checks

Cat. No. DFC-	Color	Pts.	Wt. per 300	Lot Prices		
				300	600	900
138-1	Green	1	3#	56.95	96.64	141.74
139-1	Blue	1	3#	56.95	96.64	141.74
182-1	Yellow	1	3#	56.95	96.64	141.74
183-1	Brown	1	3#	56.95	96.64	141.74
184-1	Red	1	3#	56.95	96.64	141.74
DFC-				Carbonless Lot Prices		
134-2	Green	2	6#	117.52	212.48	299.87
135-2	Blue	2	6#	117.52	212.48	299.87
182-2	Yellow	2	6#	117.52	212.48	299.87

Available in black ink only. (R)
Envelopes available on page 100. (9910)

NOTE:

When Ordering Checks

Be sure to send a voided check or bank specification sheet to ensure correct MICR encoding.

Screened Background Colors

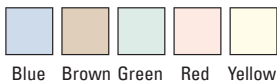

Blue Brown Green Red Yellow



Check Numbering
Starting Number: Choose a six-digit starting number for your imprinted form at no extra charge! Otherwise, we will start with 001001. Four, five and seven-digit numbering available at an additional charge. See page 142 for pricing.

Blank forms will be sequentially numbered unless specified otherwise.



Colors correspond to sequence and number of parts selected in your order unless otherwise specified.

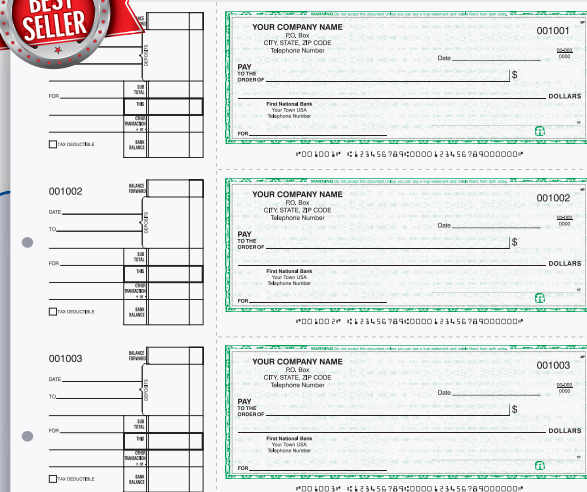

C DFC-142, 143, 136, 137, 174, 175, 176 - 3-Ring Binder Checks

General Expense Checks, 8½" x 3½"
13" x 11" Overall
2-Part - 300 Checks/100 Sheet Sets
1-Part - 300 Checks/100 Sheets

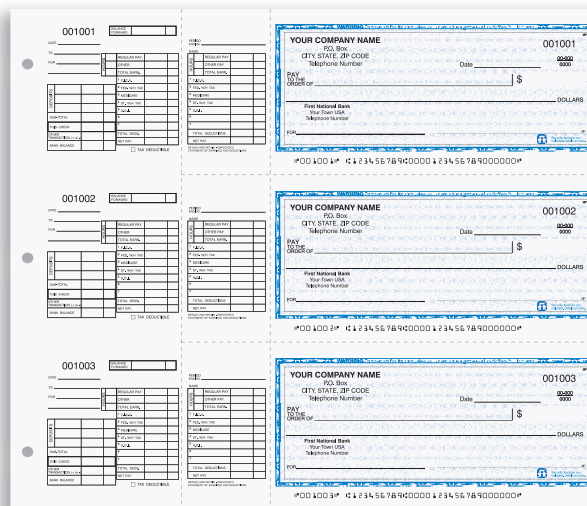

D DFC-138, 139, 134, 135, 182, 183, 184 - 3-Ring Binder Checks

Payroll Checks, 7½" x 3½"
13" x 11" Overall
2-Part - 300 Checks/100 Sheet Sets
1-Part - 300 Checks/100 Sheets

See page 95 for 3-Ring Binders

Photocopy and write your present check MICR number in the boxes below or use your bank specification sheet.

43	42	41	40	39	38	37	36	35	34	33	32	31	30	29	28	27	26	25	24	23	22	21	20	19	18	17	16	15	14	13
----	----	----	----	----	----	----	----	----	----	----	----	----	----	----	----	----	----	----	----	----	----	----	----	----	----	----	----	----	----	----

Please note: Any numbers to the left of the numbers within the symbols are not needed to process your order.

A = B = Blank

Checks & Deposit Tickets

High Security Features

Chemical Reactive Box, Chemical Reactive Paper, Microprint Endorsement Lines, Warning Band Diagonal Dimensional Backer, Invisible Embedded Fibers, Thermochromic Icon and Padlock Icon

- A LC-5770, 5771, 5772**
 General Purpose Laser Check, 8½" x 11" Overall
 Top Position
 Imprint area 1½" x 3¼"
 Corresponding Envelope 9854, 9855

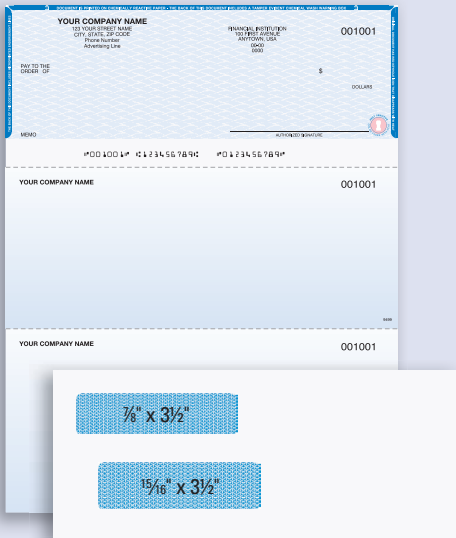

- B ENV-9854, 9855**

- C LC-5776, 5777, 5778**
 General Purpose Laser Check, 8½" x 11" Overall
 Center Position
 Imprint area 1½" x 3¼"
 Corresponding Envelope 9856, 9857



- D ENV-9856, 9857**

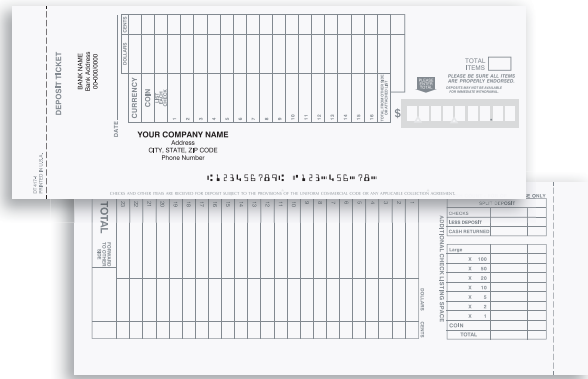

- E DT-417 Booked**
 Deposit Ticket, 8½" x 3½"
 Imprint area 5/8" x 4"
 1pt - 100 deposit ticket/sheets per book
 39 lines total: 16 front, 23 back
 2 pt - 50 sets per book
 3 pt - 50 sets per book
 17 lines front for multi-part

A LC-5770, 5771, 5772 - General Purpose Laser Checks

Cat. No.	LC-	Colors	Pts.	Wt. per 1M	Lot Prices				
					250	500	1000	2000	3000
5770		Blue	1	11#	76.47	98.35	134.76	236.43	275.35
5771		Green	1	11#	76.47	98.35	134.76	236.43	275.35
5772		Brown	1	11#	76.47	98.35	134.76	236.43	275.35

B ENV-9854, 9855 - Double Window Envelopes (Corresponds with Checks 5770-5772)

Cat. No.	ENV-	Type	Size	Wt. per 500	Lot Prices				
					500	1000	2000	3000	5000
9854		Gummed	3¾" x 8¾"	7#	43.73	78.47	154.18	224.07	353.96
9855		Self Seal	3¾" x 8¾"	7#	53.20	94.48	184.55	271.08	432.69

Not available imprinted.

C LC-5776, 5777, 5778 - General Purpose Laser Checks

Cat. No.	LC-	Colors	Pts.	Wt. per 1M	Lot Prices				
					250	500	1000	2000	3000
5776		Blue	1	11#	76.47	98.35	134.76	236.43	275.35
5777		Green	1	11#	76.47	98.35	134.76	236.43	275.35
5778		Brown	1	11#	76.47	98.35	134.76	236.43	275.35

D ENV-9856, 9857 - Double Window Envelopes (Corresponds with Checks 5776-5778)

Cat. No.	ENV-	Type	Size	Wt. per 500	Lot Prices				
					500	1000	2000	3000	5000
9856		Gummed	3¾" x 8¾"	7#	43.73	78.47	154.18	224.07	353.96
9857		Self Seal	3¾" x 8¾"	7#	53.20	94.48	184.55	271.08	432.69

Not available imprinted.

E DT-417 - Deposit Ticket

Cat. No.	DT-	Pts.	Wt. per 2 Bks	Carbonless Lot Prices		
				2 Bks	4 Bks	6 Bks
417-1		1	1#	36.21	54.06	87.50
417-2		2	1#	61.82	80.31	106.59
417-3		3	2#	72.30	93.83	125.20

Available in black ink only.
 Not available numbered.

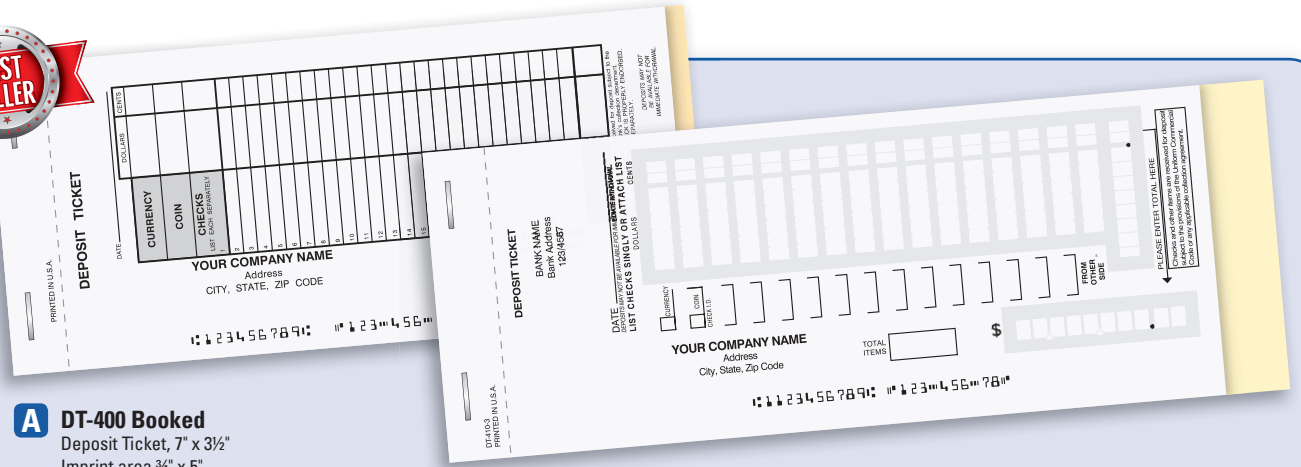

A DT-400 Booked
Deposit Ticket, 7" x 3½"
Imprint area ¾" x 5"
50 sets per book

B DT-410 Booked
Deposit Ticket, 8½" x 3½"
Imprint area ¾" x 2"
50 sets per book

A DT-400 - Deposit Ticket

Cat. No.	Pts.	Wt. per 2 Bks	Carbonless Lot Prices		
			2 Bks	4 Bks	6 Bks
400-2	2	1#	61.81	80.31	106.59
400-3	3	2#	72.30	93.83	125.20

Available in black ink only. (R)
Not available numbered.

B DT-410 - Deposit Ticket

Cat. No.	Pts.	Wt. per 2 Bks	Carbonless Lot Prices		
			2 Bks	4 Bks	6 Bks
410-2	2	1#	61.81	80.31	106.59
410-3	3	2#	72.30	93.83	125.20

Available in black ink only. (R)
Not available numbered.

C DT-411 - Deposit Ticket

Cat. No.	Pts.	Wt. per 2 Bks	Carbonless Lot Prices		
			2 Bks	4 Bks	6 Bks
411-2	2	1#	61.81	80.31	106.59
411-3	3	2#	72.30	93.83	125.20

Available in black ink only. (R)
Not available numbered.

D DT-412 - Deposit Ticket

Cat. No.	Pts.	Wt. per 2 Bks	Carbonless Lot Prices		
			2 Bks	4 Bks	6 Bks
412-2	2	1#	61.81	80.31	106.59
412-3	3	2#	72.30	93.83	125.20

Available in black ink only. (R)
Not available numbered.

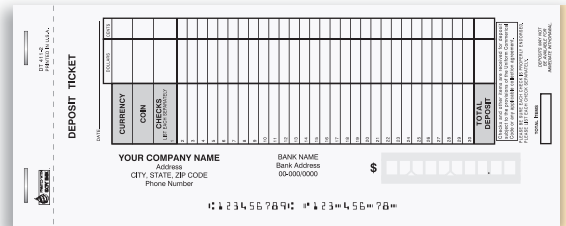

C DT-411 Booked
Deposit Ticket, 8" x 3½"
Imprint area ¾" x 4"
50 sets per book

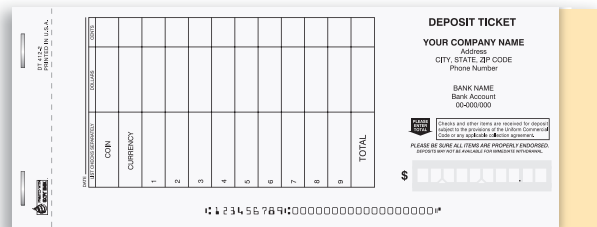

D DT-412 Booked
Deposit Ticket, 8" x 3½"
Imprint area 1¼" x 2½"
50 sets per book

NOTE:

When Ordering Deposit Tickets

Be sure to send a deposit ticket or bank specification sheet to ensure correct MICR encoding.



Colors correspond to sequence and number of parts selected in your order unless otherwise specified.

Photocopy and write your present check MICR number in the boxes below or use your bank specification sheet.

43	42	41	40	39	38	37	36	35	34	33	32	31	30	29	28	27	26	25	24	23	22	21	20	19	18	17	16	15	14	13
----	----	----	----	----	----	----	----	----	----	----	----	----	----	----	----	----	----	----	----	----	----	----	----	----	----	----	----	----	----	----

Please note: Any numbers to the left of the numbers within the ■ symbols are not needed to process your order.

A = ■ - = ■ B = Blank

Deposit Tickets

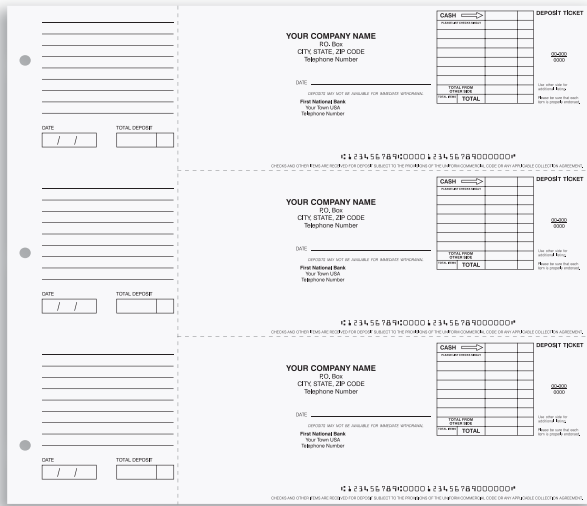

A DT-413 - 3-Ring Deposit Tickets
General Expense Deposit Tickets, 8½" x 3½"
13" x 11" Overall
1-Part - 300 Deposit Tickets/100 Sheets

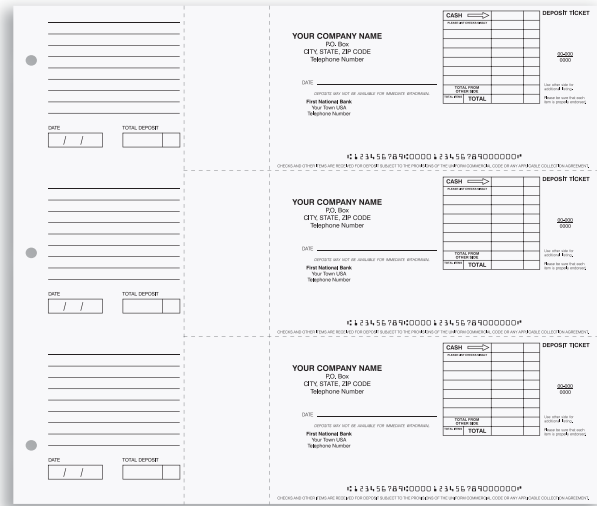

B DT-414 - 3-Ring Deposit Tickets
Payroll Deposit Tickets, 7½" x 3½"
13" x 11" Overall
1-Part - 300 Deposit Tickets/100 Sheets

Smaller Size

C DT-415 - 3-Ring Deposit Tickets
General Expense Deposit Tickets, 8¼" x 3"
13" x 9" Overall
1-Part - 300 Deposit Tickets/100 Sheets

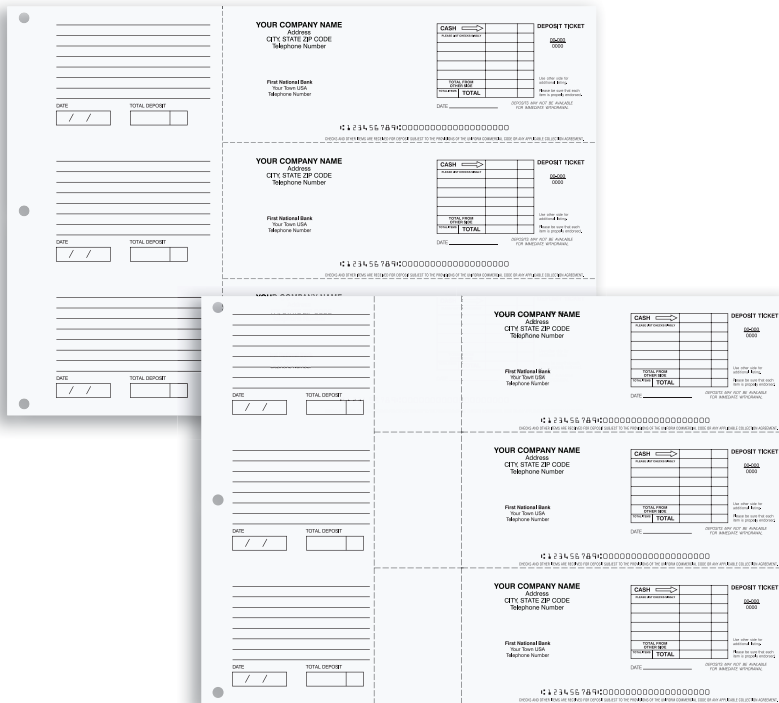

D DT-416 - 3-Ring Deposit Tickets
Payroll Deposit Tickets, 7¼" x 3"
13" x 9" Overall
1-Part - 300 Deposit Tickets/100 Sheets

A DT-413 - General Expense Deposit Tickets

Cat. No.	Wt.	Lot Prices
DT-	Pts.	per 100 100 Sheets
413-1	1	2# 47.86

Available in black ink only. (R)

B DT-414 - Payroll Deposit Tickets

Cat. No.	Wt.	Lot Prices
DT-	Pts.	per 100 100 Sheets
414-1	1	2# 47.86

Available in black ink only. (R)

C DT-415 - General Expense Deposit Tickets

Cat. No.	Wt.	Lot Prices
DT-	Pts.	per 100 100 Sheets
415-1	1	2# 47.86

Available in black ink only. (R)

D DT-416 - Payroll Deposit Tickets

Cat. No.	Wt.	Lot Prices
DT-	Pts.	per 100 100 Sheets
416-1	1	2# 47.86

Available in black ink only. (R)

NOTE:

3
Day
Shipping

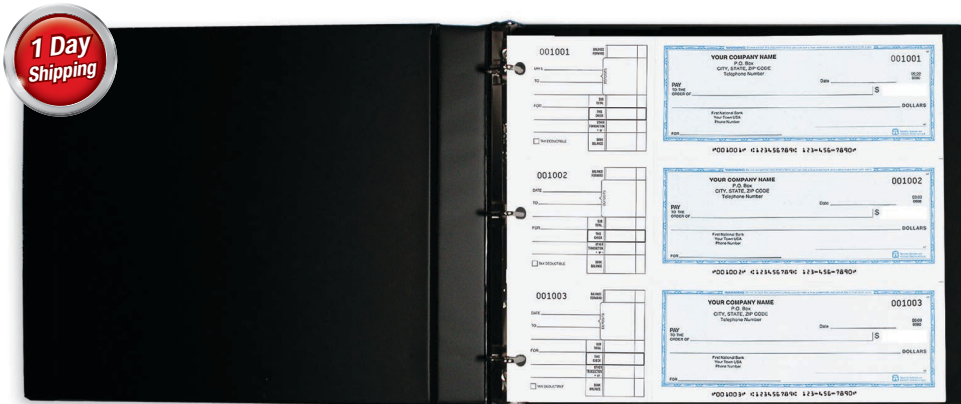

A RB-9984
3-Ring Check Binder, 14" x 11 1/2"
Vinyl
Checks not included.

RB-9985 - SMALLER SIZE
3-Ring Check Binder, 14" x 10"
Vinyl
Checks not included

RB-9987
3-Ring Check Binder, 14" x 11 1/2"
55 Gauge Polyethylene
Checks not included

B DCR-9930
Daily Cash Report Envelope
6" x 9"

Thank you for banking
with us!

Thinking about starting
a savings account
for your child?



Ask us
about our
Youth Accounts!

Sample Artwork

www.YourCreditUnionOne.com

C ENV-4420
Teller Helper Envelope, 7 x 3 1/4"
Front imprint area 3 1/4" x 7"
Flap imprint area 3" x 3/4"
Latex self seal

ENV-4421
Teller Helper Envelope, 7 x 3 1/4"
Front imprint area 3 3/4" x 7"
Flap imprint area 2 1/2" x 3/4"
Latex self seal

*Your Custom art
will be used.
1-color to 4-color,
same low price.*



A RB-9984, 9985, 9987 - 3-Ring Check Binder

Cat. No.	Size	Material	Wt.	Per Binder 100
9984	14 3/4" x 11 1/2"	Vinyl	1#	36.14
9985	14" x 10"	Vinyl	1#	36.14
9987	14 3/4" x 11 1/2"	Polyethylene	1#	42.48

Checks not included. (R)

B DCR-9930 - Daily Cash Report Envelope

Cat. No.	Wt. per 1000	100	250	500	1000	2000
9930	24#	57.81	82.58	137.74	228.70	389.32

Not available imprinted. (R)

C ENV-4420, ENV-4421 - Teller Helper Envelope

Cat. No.	Size	Wt. per 250	100	250	500	1000	2500
4420	7" x 3 1/4"	3#	80.60	140.40	263.46	426.40	592.80
4421	7" x 3 3/4"	3#	80.60	140.40	263.46	426.40	592.80

1-color to 4-color process is the same price. (R)

NOTE:

! For Binder Checks, see pages 90-91.

Document Jackets

Format 2
Real Estate

Format 3
Medical 1

Format 4
Medical 2

Format 5
Personnel

Format 6
Job Ticket

Format 7
Wedding

B ENV-9955 - 9959
Document Jackets
28# Prism-Colors, 12" x 9 1/4"
Imprint area 8 1/2" x 10 1/8"
Front or back

Format 1 - Automotive

Back

Front



A ENV-9940
Document Jackets
100# Manila Tag, 12" x 9 1/4"
Imprint area 8 1/2" x 10 1/8"
Front or Back

A ENV-9940 Document Jackets - Manila

Cat. No.	Wt.	Lot Prices			
		250	500	1000	2500
ENV-9940	58#	182.78	245.80	351.05	691.24
Blank Lot Prices					
9940	58#	137.12	208.99	317.56	660.56

Printing on second side for additional charge. (R)
Printed on 100# Manila Tag.

B ENV-9955 - 9959 Document Jackets - Colors

Cat. No.	Color	Wt.	Imprinted Lot Prices			
			250	500	1000	2500
9955	Canary	58#	227.29	293.23	430.92	984.83
9956	Blue	58#	227.29	293.23	430.92	984.83
9957	Green	58#	227.29	293.23	430.92	984.83
9958	Pink	58#	227.29	293.23	430.92	984.83
9959	White	58#	227.29	293.23	430.92	984.83
Blank Lot Prices						
9955	Canary	58#	170.51	234.68	408.46	954.15
9956	Blue	58#	170.51	234.68	408.46	954.15
9957	Green	58#	170.51	234.68	408.46	954.15
9958	Pink	58#	170.51	234.68	408.46	954.15
9959	White	58#	170.51	234.68	408.46	954.15

Printing on second side for additional charge. (R)
Printed on 28# Prism.

NOTE:



Includes your company's name, address and phone number in one of four colors! For blank forms, subtract 30% unless otherwise listed.



! Choose from one of our standard formats or submit your custom copy.



PF-8832 Presentation Folder

Double pocket, 9" x 12" overall
Business card slits on one pocket included
Imprint: As shown with design, one color or foil
Line 1: 25 characters
Line 2-4: 30 characters each
Foil imprint: Max 16 square inches



PF-8833 Presentation Folder

Single pocket, 9" x 12" overall
Business card slits included
Imprint: As shown with design, one color or foil
Line 1: 20 characters
Line 2-4: 30 characters each
Foil imprint: Max 16 square inches

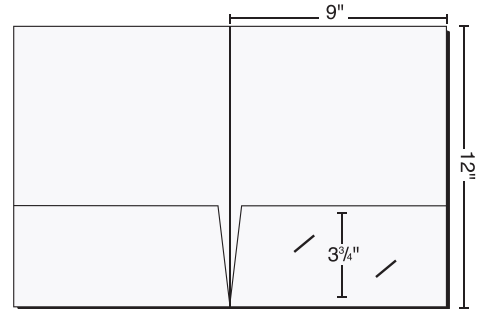

Right pocket only for PF-8833

PF-8833, 8832, 8834 Presentation Folders

Cat. No.	Wt. per 500	Imprinted Lot Prices				
		500	1000	1500	2000	3000
8832	55#	884.00	1,352.00	1,664.00	2,080.00	2,808.00
8833	55#	884.00	1,352.00	1,664.00	2,080.00	2,808.00
8834	55#	884.00	1,352.00	1,664.00	2,080.00	2,808.00

(R)

NOTE:

Proof Information

Black & White Laser Proof	\$11.22
PDF Proof (Not for color)	\$11.22
Normal production time is required after return of proof.	
Changes made at proofing may incur additional charges.	
Proofs must be requested at time of order.	

Imprint Colors

May be imprinted in black, 1 PMS color or one of the following foils:

Black	Burgundy	Copper	Flat Gold
Flat Silver	Green	Light Blue	Medium Blue
Purple	Rainbow	Red	Shiny Gold
Shiny Silver	Turquoise	White	

Stock Papers

Rite:	Mohawk Loop:
Coated 10 pt C1S (White)	Feltmark 80# Cover (Granite, Ivory)
Felt 80# Cover (Snow White)	Linen 80# Cover (Gray, Ivory)
Linen 80# Cover (Snow White)	Smooth 80# Cover (Granite, Ivory)



Stock Colors

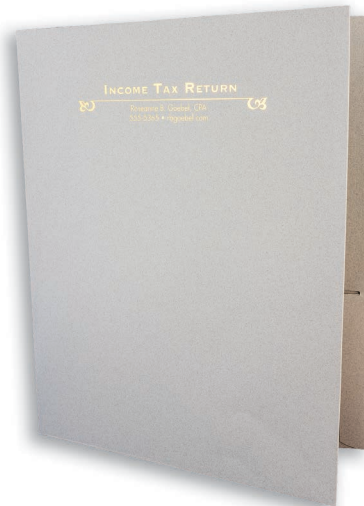
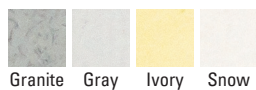

PF-8834 Presentation Folder

Reinforced double pocket, 9 5/8" x 11 3/4" overall
Business card slits on one pocket included
Imprint: As shown with design, one color or foil
Line 1: 20 characters
Line 2-3: 25 characters each
Foil imprint: Max 16 square inches

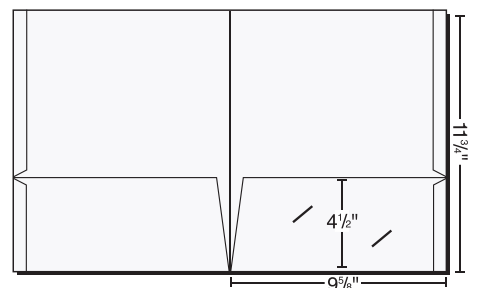

The edges are folded and glued

Envelopes

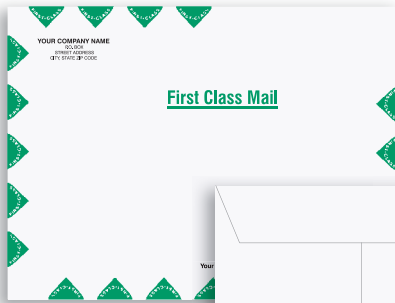

**ENV-9838 - Tyvek®
Catalog Envelope**
Open end, 10" x 13"
Imprint area 8½" x 11½"

**ENV-9839 - Tyvek®
Catalog Envelope**
Open end, 9" x 12"
Imprint area 8¾" x 11¼"

**ENV-9840 - Tyvek®
Catalog Envelope**
Open end, 10" x 13"
Imprint area 9½" x 12¼"

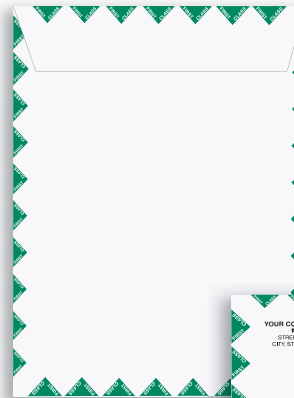

**ENV-9835 - Kraft®
Catalog Envelope**
Open end, 9" x 12"
Imprint area 8" x 10¾"



**ENV-9837 - Kraft®
Catalog Envelope**
Open end, 10" x 13"
Imprint area 9" x 12"



**ENV-9832 - White 28#
Booklet Envelope**
Open side, 6" x 9"
Imprint area 5¾" x 8¼"

**ENV-9834 - White 28#
Booklet Envelope**
Open side, 9" x 12"
Imprint area 8¾" x 11¼"



**ENV-9833 - White 28#
Catalog Envelope**
Open end, 9½" x 12½"
Imprint area 8¾" x 11¼"

**ENV-9831 - White 24#
Catalog Envelope**
Open end, 6" x 9"
Imprint area 5¾" x 8¼"

Tyvek® Envelopes

Cat. No.	ENV-	Size	Wt. per 1000	Imprinted Lot Prices		
				100	250	500
9838	10" x 13"	24#	157.97	318.91	538.91	863.93
9839	9" x 12"	20#	135.25	279.32	481.37	774.26
9840	10" x 13"	24#	150.29	303.77	525.28	828.99

Back printing not available.
Available in black ink only.

(R)

Kraft® Envelopes

Cat. No.	ENV-	Size	Wt. per 1000	Imprinted Lot Prices			
				100	250	500	1000
9835	9" x 12"	38#	85.50	117.30	183.17	288.95	554.59
9837	10" x 13"	44#	104.32	141.64	233.68	365.85	683.30

Back printing not available.

(R)

White Envelopes

Cat. No.	ENV-	Size	Wt. per 1000	Imprinted Lot Prices			
				100	250	500	1000
9831	6" x 9"	24#	59.76	88.85	129.09	187.39	334.70
9832	6" x 9"	28#	59.33	88.31	116.22	170.08	311.01
9833	9½" x 12½"	42#	82.26	117.52	183.06	289.17	587.15
9834	9" x 12"	38#	84.42	117.30	156.45	224.81	438.21

Back printing not available.

(R)

NOTE:



Includes your company's name, address and phone number in one of four colors! For blank forms, subtract 30% unless otherwise listed.



DuPont™
Tyvek®
Protect what's inside.™
Tyvek® Envelopes have pressure sensitive seals.

! Deduct 30% for blank envelopes these two pages.

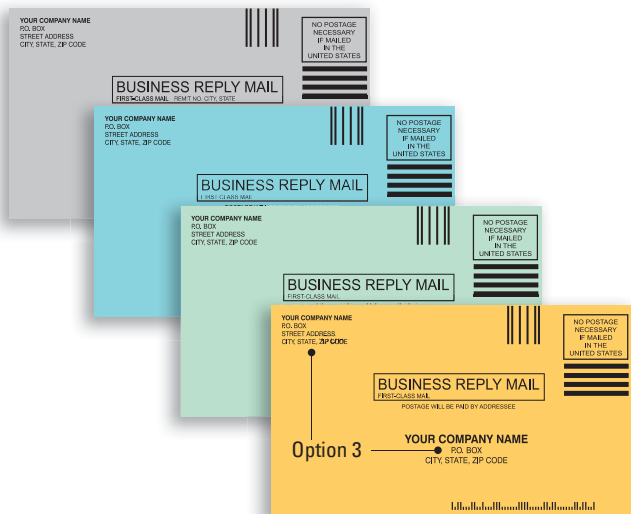

ENV-9814-9818 - #6 3/4 Envelopes
3 1/2" x 6"

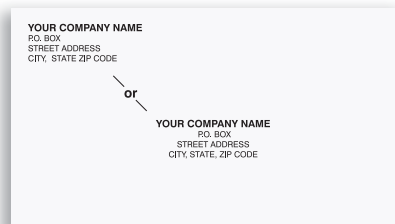

ENV-9823 - #6 3/4 Envelopes
Tinted, 3 3/4" x 6 1/2"

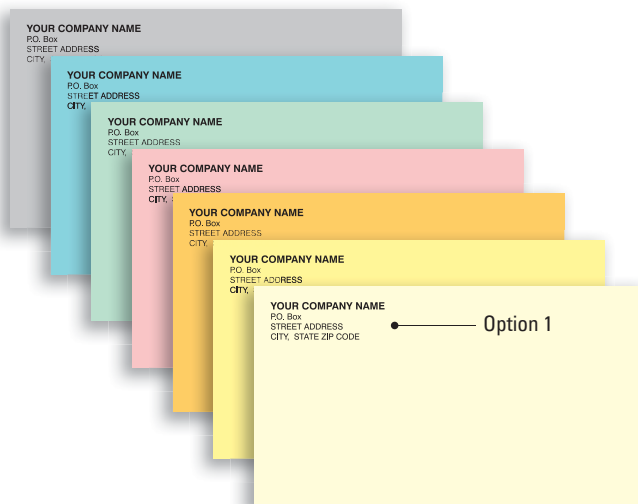

ENV-9824-9830 - #6 3/4 Envelopes
3 3/4" x 6 1/2"

#6 3/4 & #6 3/4 Envelopes

Cat. No.	ENV-	Size	Color	Wt. per 500	Imprinted Lot Prices			
					500	1000	2000	4000
9814	#6 3/4	Gray	5#	74.93	112.48	176.87	322.22	
9815	#6 3/4	Blue	5#	74.93	112.48	176.87	322.22	
9816	#6 3/4	Green	5#	74.93	112.48	176.87	322.22	
9818	#6 3/4	Goldenrod	5#	74.93	112.48	176.87	322.22	
9823*	#6 3/4	White	5#	74.93	112.48	176.87	322.22	
9824	#6 3/4	Gray	5#	74.93	112.48	176.87	322.22	
9825	#6 3/4	Blue	5#	74.93	112.48	176.87	322.22	
9826	#6 3/4	Green	5#	74.93	112.48	176.87	322.22	
9827	#6 3/4	Pink	5#	74.93	112.48	176.87	322.22	
9828	#6 3/4	Goldenrod	5#	74.93	112.48	176.87	322.22	
9829	#6 3/4	Canary	5#	74.93	112.48	176.87	322.22	
9830	#6 3/4	Creme	5#	74.93	112.48	176.87	322.22	

*Tinted inside.

(R)

#9 Envelopes

Cat. No.	ENV-	Size	Color	Wt. per 500	Imprinted Lot Prices			
					500	1000	2000	4000
9804	#9	Gray	7#	103.41	142.54	226.30	335.85	
9805	#9	Blue	7#	103.41	142.54	226.30	335.85	
9806	#9	Green	7#	103.41	142.54	226.30	335.85	
9807	#9	Pink	7#	103.41	142.54	226.30	335.85	
9809	#9	Canary	7#	103.41	142.54	226.30	335.85	
9810	#9	Creme	7#	103.41	142.54	226.30	335.85	

(R)

NOTE:

3 Imprint options available in all sizes.

- 1 - Upper Left
- 2 - Center
- 3 - Barcoded - Upper Left or Center



ENV-9804-9810 - #9 Envelopes
3 3/8" x 8 1/2"

Envelopes

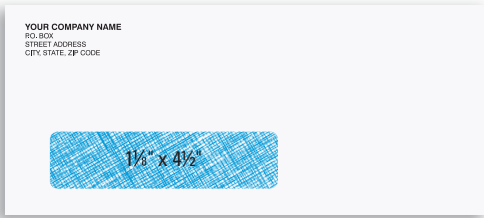

ENV-9901 - #10 Envelope
Security window, 4 1/8" x 9 1/2"

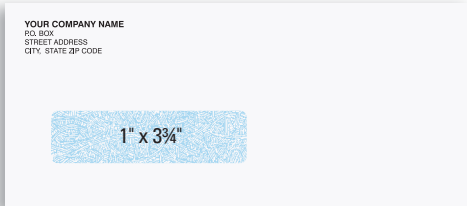

ENV-9905 - #9 Automotive Invoice Envelope
Security window, 3 7/8" x 8 7/8"

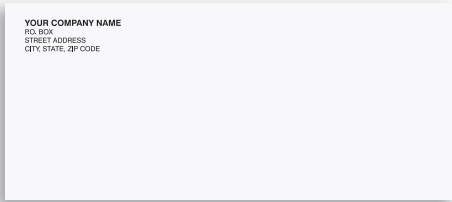

ENV-9906 - #9 Envelope
Regular (no window), 3 7/8" x 8 7/8"

ENV-9962 - #9 Envelope
Regular (no window), 3 7/8" x 8 7/8", **Recycled**

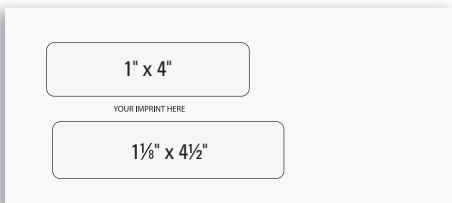

ENV-9907 - #9 Envelope
Double window, 3 7/8" x 8 7/8"

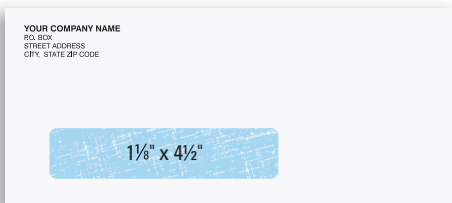

ENV-9908 - #9 Envelope
Security window, 3 7/8" x 8 7/8"

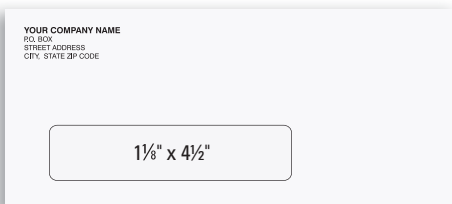

ENV-9909 - #9 Envelope
Single window, 3 7/8" x 8 7/8"

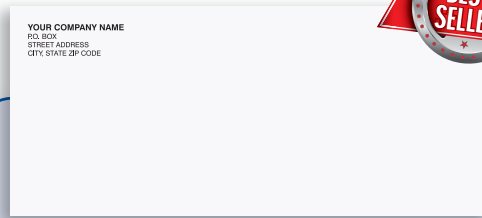

ENV-9910 - #10 Envelope
Regular (no window), 4 1/8" x 9 1/2"

ENV-9963 - #10 Envelope
Regular (no window), 4 1/8" x 9 1/2", **Recycled**

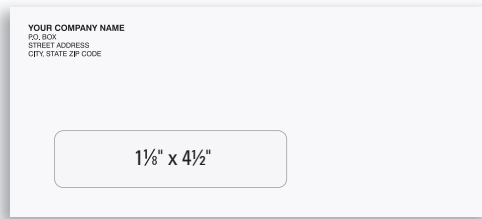

ENV-9911 - #10 Envelope
Single window, 4 1/8" x 9 1/2"

ENV-9964 - #10 Envelope
Single window, 4 1/8" x 9 1/2", **Recycled**

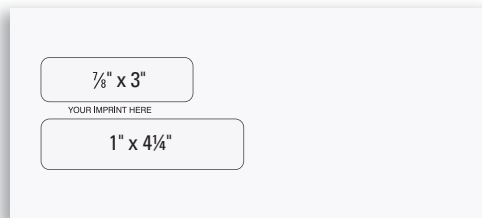

ENV-9912 - #10 Envelope
Double window, 4 1/8" x 9 1/2"



ENV-9913 - #6 3/4 Envelope
Single window, 3 7/8" x 6 1/2"

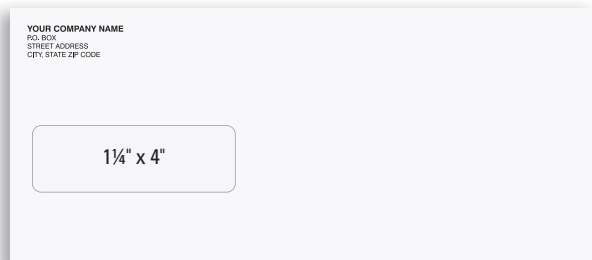

ENV-9914 - #14 Envelope
Single window, 5" x 11 7/16"



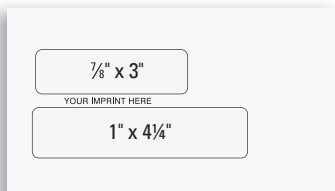

ENV-9915 - #6 3/4 Envelope
Double window, 3 3/8" x 6 1/2"

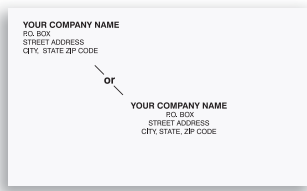

ENV-9916 - #6 3/4 Envelope
Regular (no window), 3 1/2" x 6"

ENV-9919 - #6 3/4 Envelope
Regular (no window), 3 3/8" x 6 1/2"

See page 99 for imprint position options.

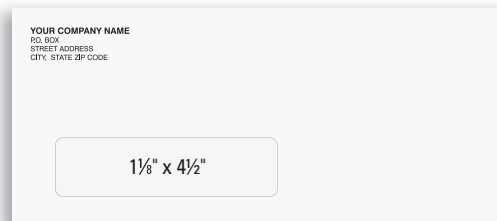

ENV-9917 - #10 Envelope
Self-sealing (no window), 4 1/8" x 9 1/2"

ENV-9918 - #10 Envelope
Self-sealing, single window, 4 1/8" x 9 1/2"

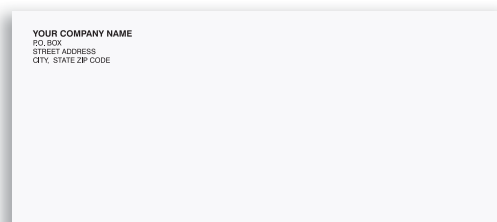

ENV-9937 - #10 Envelope
Tinted regular (no window), 4 1/8" x 9 1/2"
See page 99 for imprint position options.

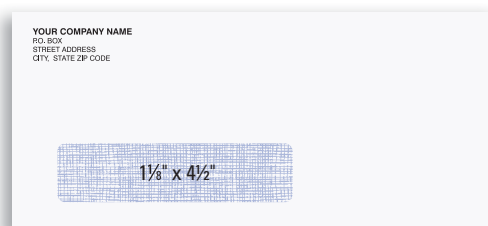

ENV-9939 - #10 Envelope
Tinted, self-sealing, single window
4 1/8" x 9 1/2"

ENV-9938 - #10 Envelope
Tinted, self-sealing (no window)
4 1/8" x 9 1/2"

Envelopes

Cat. No.	Size	Wt. per 500	Imprinted Lot Prices				
			500	1000	2000	3000	5000
9901	10	8#	74.58	114.70	226.76	335.57	556.86
9905	9	7#	74.58	114.70	226.76	335.57	556.86
9906	9	7#	53.92	85.18	168.68	250.12	418.85
9907	9	7#	94.37	159.91	299.33	428.04	678.97
9908	9	7#	111.89	168.46	283.76	386.51	624.14
9909	9	7#	69.60	111.78	205.23	296.20	479.85
9910	10	8#	74.47	124.76	217.46	315.45	510.68
9911	10	8#	77.06	132.77	239.09	348.22	562.38
9912	10	8#	92.86	166.08	305.82	452.70	702.34
9913	6 3/4	5#	79.01	130.60	231.41	334.38	539.56
9914	14	10#	107.24	159.91	298.90	427.72	668.37
9915	6 3/4	5#	91.02	155.26	288.52	409.66	654.85
9916	6 1/4	5#	76.74	114.92	213.78	306.04	469.25
9919	6 3/4	5#	72.20	124.44	224.05	317.61	512.19
9937	10	8#	86.37	130.39	236.60	330.81	512.08
ENV-	Blank Lot Prices						
9914	14	10#	91.12	135.90	254.23	363.58	568.11
9937	10	8#	60.41	91.23	165.65	231.52	358.39

All others deduct 30% for blank envelopes. (R)

Recycled Envelopes

Cat. No.	Size	Wt. per 500	Imprinted Lot Prices				
			500	1000	2000	3000	5000
9962	9	7#	71.87	114.49	194.74	290.14	470.33
9963	10	8#	78.25	131.14	228.38	331.24	536.20
9964	10	8#	80.96	139.26	250.88	365.42	590.50

Deduct 30% for blank envelopes. (R)

Self Sealing Envelopes

Cat. No.	Size	Wt. per 500	Imprinted Lot Prices		
			500	1000	2000
9917	10	8#	110.27	192.04	357.64
9918	10	8#	142.28	202.75	377.75
9938	10	8#	136.45	196.48	338.17
9939	10	8#	143.04	205.13	352.77
			Blank Lot Prices		
9917	10	8#	101.50	140.34	262.02
9918	10	8#	112.86	151.15	282.13
9938	10	8#	112.11	150.18	283.33
9939	10	8#	132.44	190.09	327.02

(R)

Recycled Envelopes are 24# White Recovery which meets or exceeds the 30% recycled content guidelines for EPA. Available in #9 (ENV-9962) or #10 (ENV-9963) regular no window or #10 (ENV-9964) single window versions.

NOTE:

Envelope Window Positioning

Item		Bottom	Left
9901		1/2"	7/8"
9905		1 3/16"	7/8"
9907	Top Window	2 1/4"	1 3/16"
	Bottom Window	9/16"	7/8"
9908		1/2"	7/8"
9909		1/2"	7/8"
9911		1/2"	7/8"
9912	Top Window	2 1/4"	1 1/16"
	Bottom Window	7/8"	5/8"
9913		9/16"	7/8"
9914		1 1/16"	3/8"
9915	Top Window	2 1/16"	1/2"
	Bottom Window	3/4"	7/16"
9918		1/2"	7/8"
9939		1/2"	7/8"

Need Special Information Added to the Face of Your Envelope?

You can choose from:

- Statement Enclosed
- Reply Requested
- Important Information
- Bill Enclosed
- Open Immediately
- Special Offer

or Submit Your Own Copy



Includes your company's name, address and phone number in one of four colors! For blank forms, subtract 30% unless otherwise listed.

! Don't see the Envelope you need? We can get it for you.



Create The Perfect Form.

You can create a form that works for you. You have the choice of eight perf positions or no perf. Add one or two file holes in the top or bottom or three hole punches for a binder.

Finish your form with one or all of these **FREE** options.

- One of our Stock Logos from pages 134-136
- Stock Logo as a phantom
- White, Navy Blue, Hunter Green or Burgundy paper
- Choice of Form Identifier

We will print your 1-color Full Page Custom Design for just \$64.58(R) additional art charge.

Note: Blank My Choice CreationsSM colors are the same as imprinted price per lot. For blank white stock, deduct 30%.

NOTE:

Available in White or 3 Great Colors!



For Blank White Stock, deduct 30%.

FREE! - Add a Form Identifier

For available typestyles, see page 104.

- | | | |
|-------------------|--------------|-----------------|
| • Statement | • Past Due | • Receipt |
| • Purchase Order | • Proposal | • Bulletin |
| • Sales Order | • Reminder | • Urgent |
| • Packing List | • Invoice | • Credit Memo |
| • Overdue Account | • Work Order | • Change Notice |
| • Thank You | • Quotation | • Final Notice |
| • Debit Memo | • Memo | • Requisition |
| • Agreement | • Estimate | • Job Invoice |



Includes your company's name, address and phone number in one of four colors! For blank forms, subtract 30% unless otherwise listed.

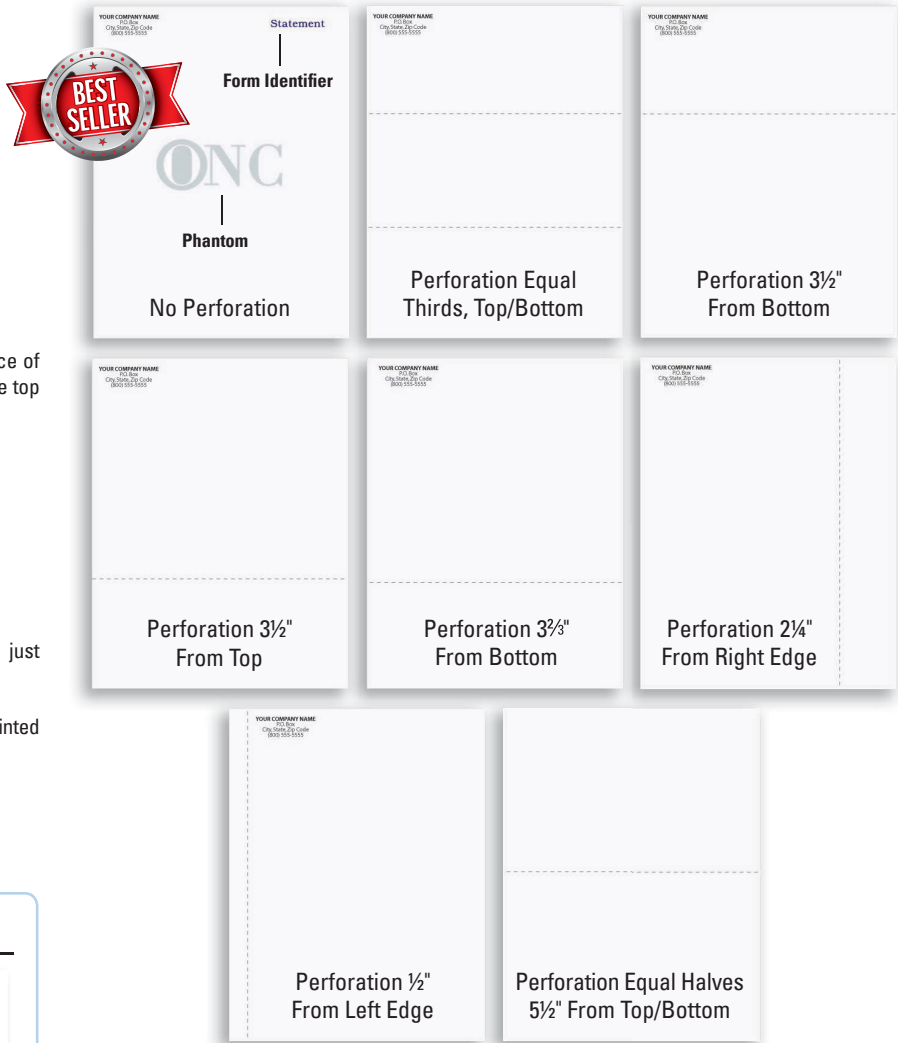

My Choice CreationsSM 8 1/2" x 11" Perforated Stock

Cat. No.		Position	Wt. per 1000	Imprinted Lot Prices				
20#	24#			250	500	1000	2000	3000
5701	5711	No Perf	11#	79.55	119.68	154.51	249.47	330.37
5702	5712	Equal Thirds	11#	79.55	119.68	154.51	249.47	330.37
5703	5713	3 1/2" from Top	11#	79.55	119.68	154.51	249.47	330.37
5704	5714	3 1/2" from Bottom	11#	79.55	119.68	154.51	249.47	330.37
5705	5715	3 3/8" from Bottom	11#	79.55	119.68	154.51	249.47	330.37
5706	5716	2 1/4" from Rt. Edge	11#	79.55	119.68	154.51	249.47	330.37
5708	5718	1/2" from Lt. Edge	11#	79.55	119.68	154.51	249.47	330.37
5709	5719	Equal Halves	11#	79.55	119.68	154.51	249.47	330.37

Not available numbered. (R)

Envelopes available on page 100. (9910)

For Hole Punched Forms, add:

	Lot Prices				
	250	500	1000	2000	3000
1 & 2 Hole Punch	25.13	25.13	25.13	29.81	34.28
3 & 4 Hole Punch	39.69	39.69	39.69	44.48	47.91

1/4" hole, 1/4" from the edge of the paper. (R)

Don't Forget Your Compatible Envelopes. All My Choice Creations forms fit our standard #10 envelope (ENV-9910, no window). See page 100.

Reliable. Dependable. Professional. Make the best impression with your business stationery.

Your business stationery, letterhead, envelopes and business cards are important investments. They can be the first impression your client receives about your business. Make that image one that will impress your clients with your dependability and strength.



A Envelopes
Standard size #9 & #10



B 495650 - Business Stationery Package
24# white accent opaque paper
Card stock is 65#

A Full-Color Envelopes

Cat. No.	Description	Wt. per 500	Imprinted Lot Prices			
			250	500	1000	2500
495660	#10 Regular	8#	117.19	151.37	171.27	342.60
495670	#9 Regular	8#	117.19	151.37	171.27	342.60
495680	#10 Window	8#	126.22	160.46	180.30	378.67
495690	#10 Window with Tint	8#	129.79	165.86	189.28	396.68

(R)

B Business Stationery Package

Cat. No.	Description	Wt. per 1000	Imprinted Lot Prices			
			250	500	1000	2500
495650	Envelopes, Letterhead, Business Cards	24#	232.54	304.69	376.83	701.36

No Watermark
Letterhead 8½" x 11"
#10 Envelope 4½" x 9½"
Business Cards 3½" x 2"

(R)

**No Bleeds,
Digital Files Required**

NOTE:



Business Stationery

Choose a typestyle, paper stock and ink color for attractive, matching business stationery. Give your stationery a finished look by adding your company logo for \$40.27(R), first time only charge or choose one of our stock logo's from pages 134-136. Or submit your own custom art.



20# Watermark Stationery

Cat. No.	Item	Color	Lot Price - Black Ink				
			500	1000	2000	3000	5000
323000	Letterhead	White	95.78	138.07	236.82	336.65	516.41
333000	Envelope	White	131.36	188.04	350.28	496.18	773.94

Card stock not available. (R)

24# 25% Cotton Stationery

Cat. No.	Item	Color	Lot Price - Black Ink				
			500	1000	2000	3000	5000
324000	Letterhead	White	102.16	143.91	245.79	345.41	536.64
334000	Envelope	White	122.92	184.36	313.18	447.94	707.85

Card stock not available. (R)

24# Linen Stationery

Cat. No.	Item	Color	Lot Price - Black Ink				
			500	1000	2000	3000	5000
325100	Letterhead	White	120.00	165.11	285.06	405.11	633.21
336100	Envelope	White	144.34	205.45	382.83	541.61	846.73

Card stock not available. (R)

24# White Accent Opaque

Cat. No.	Item	Color	Lot Price - Black Ink	
			500	1000
493000	Letterhead	White	127.14	170.19
494000	Envelope	White	136.66	187.71
495000	Card*	White	46.24	50.67

*Card Stock is 65# White Accent Opaque. (R)
No Watermark.

24# Sulphite Ultra White Stationery

Cat. No.	Item	Color	Lot Price - Black Ink	
			500	1000
493640	Letterhead	Ultra White	127.14	170.19
494640	Envelope	Ultra White	136.66	187.71
495640	Card*	Ultra White	46.24	50.67

*Card Stock is 80# Sulphite Cover 95% brightness - Bright White. (R)
No Watermark.

24# Classic Laid Stationery

Cat. No.	Item	Color	Lot Price - Black Ink	
			500	1000
493240	Letterhead	Antique Gray	149.10	191.39
494240	Envelope	Antique Gray	179.49	241.25
495240	Card*	Antique Gray	70.25	90.26

Cat. No.	Item	Color	Lot Price - Black Ink	
			500	1000
493400	Letterhead	Natural White	149.10	191.39
494400	Envelope	Natural White	179.53	241.25
495400	Card*	Natural White	70.25	90.26

*Card Stock is 65# Classic Laid Cover. (R)
Watermarked.
Classic Laid - not available in 4-color.
Bleeds not available.

24# Strathmore Stationery

Cat. No.	Item	Color	Lot Price - Black Ink	
			500	1000
493440	Letterhead	Ultimate White	163.16	213.02
494440	Envelope	Ultimate White	198.20	265.26
495440	Card*	Ultimate White	75.44	96.42

Cat. No.	Item	Color	Lot Price - Black Ink	
			500	1000
493480	Letterhead	Natural White	163.16	213.02
494480	Envelope	Natural White	198.20	265.26
495480	Card*	Natural White	75.44	96.42

*Card Stock is 88# Strathmore Writing Center Bristol Cover. (R)
Watermarked.
Bleeds not available.

24# Classic Linen Stationery

Cat. No.	Item	Color	Lot Price - Black Ink	
			500	1000
493040	Letterhead	Antique Gray	163.16	213.02
494040	Envelope	Antique Gray	198.20	265.26
495040	Card*	Antique Gray	75.44	96.42

Cat. No.	Item	Color	Lot Price - Black Ink	
			500	1000
493080	Letterhead	Baronial Ivory	163.16	213.02
494080	Envelope	Baronial Ivory	198.20	265.26
495080	Card*	Baronial Ivory	75.44	96.42

Cat. No.	Item	Color	Lot Price - Black Ink	
			500	1000
493160	Letterhead	Avon Brilliant White	163.16	213.02
494160	Envelope	Avon Brilliant White	198.20	265.26
495160	Card*	Avon Brilliant White	75.44	96.42

Cat. No.	Item	Color	Lot Price - Black Ink	
			500	1000
493200	Letterhead	Haviland Blue	163.16	213.02
494200	Envelope	Haviland Blue	198.20	265.26
495200	Card*	Haviland Blue	75.44	96.42

*Card Stock is 80# Classic Linen Cover. (R)
Watermarked.
Classic Linen - not available in 4-color.
Bleeds not available.

NOTE:

- Thermography will be used unless specified otherwise. Thermography is NOT laser compatible.
- Black ink is standard. Other colors available at an upcharge.
- Blank stationery is available. Call for prices.
- Paper samples are available.

Additional PMS Ink Colors

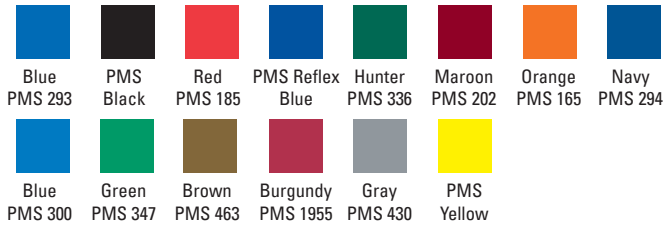

Color other than black	\$31.24
Two Color Combo	\$64.45
Proof	\$15.66
4-color process - letterhead and business cards additional charges	500 1000
	31.21 62.42

Colors shown are approximate. (R)

Available Typestyles

- | | |
|---|--|
| TA1 Bookman
TA2 Bookman Bold
TA3 Bookman Italic
TA4 Bookman Bold Italic
TB1 Helvetica
TB2 Helvetica Bold
TB3 Helvetica Italic
TB4 Helvetica Bold Italic
TC1 Cloister Black
TD1 Zapf Chancery
TE1 Brush Script
TE2 Brush Script Bold Italic | TF1 Kabel Md
TF2 Kabel Md Bold
TG1 Galliard
TG2 Galliard Bold
TG3 Galliard Italic
TG4 Galliard Bold Italic
TH1 Helvetica Narrow
TH2 Helvetica Narrow Bold
TJ1 Benguait
TJ2 Benguait Bold
TJ3 Benguait Italic
TJ4 Benguait Bold Italic |
|---|--|

Sizes

Letterhead 8½" x 11", Envelopes 4½" x 9½", Cards 2" x 3½"

Shipping Weights

Letterhead 11# per 1,000, Envelopes 10# per 1,000, Cards 3# per 1,000.
Back printing in 1 color is available on business cards for \$33.98(R) additional cost.



Includes your company's name, address and phone number in one of four colors! For blank forms, subtract 30% unless otherwise listed.



4-Color Process Digital Business Cards

A



A

4-Color Process Digital Business Cards, 10 pt. C1S White

Item Number	Description	Wt.		
		per 1000	500	1000
491200	4CP/Blank	3#	85.39	100.97
491210	4CP/4CP	3#	110.05	124.01

(R)

4-Color Process Digital Business Cards, 12 pt. C1S White

Item Number	Description	Wt.		
		per 1000	500	1000
491220	4CP/Blank	3#	95.34	111.24
491230	4CP/4CP	3#	122.38	139.36

(R)

4-Color Process Digital Business Cards, 10 pt. C2S White

Item Number	Description	Wt.		
		per 1000	500	1000
491240	4CP/Blank	3#	85.39	100.97
491250	4CP/4CP	3#	110.05	124.01

(R)

4-Color Process Digital Business Cards, 12 pt. C2S White

Item Number	Description	Wt.		
		per 1000	500	1000
491260	4CP/Blank	3#	95.34	111.24
491270	4CP/4CP	3#	122.38	139.36

*No thermography available.

(R)

B



Business Card Magnets

B

BIC® Business Card Magnet

Item Number	Description	Price Per Piece			
		500	1000	2500	5000
MGBC30	Card Magnet	0.69	0.60	0.56	0.50

(R)

Size: 3½" x 2"

Stock: 30 mil.

Imprint Color: 4-Color Process.

Personalization: Available for \$3.11(R) per name, up to 25 characters.

Optional Personalization: Multiple names on a minimum quantity order. Get one name printed on a 500 quantity order or ten different names at 50 quantity for each name.

Text should remain within 1⅞" x 3⅜".

Full bleeds available.

Note: Free round corners available.

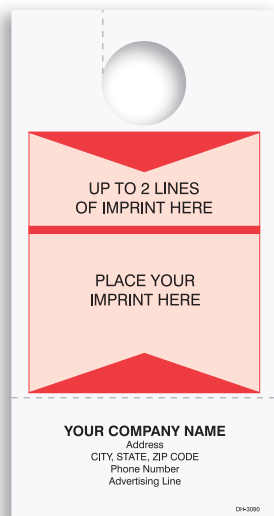

Format-3090
Red Door Hanger
Imprint area: Top 1/2" x 3"
Middle 1/4" x 3"
Bottom 1/4" x 3 1/2"

Format-3097
Blue Door Hanger
Imprint area: Top 1/2" x 3"
Middle 1/4" x 3",
Bottom 1/4" x 3 1/2"

Format-3098
Green Door Hanger
Imprint area: Top 1/2" x 3"
Middle 1/4" x 3",
Bottom 1/4" x 3 1/2"

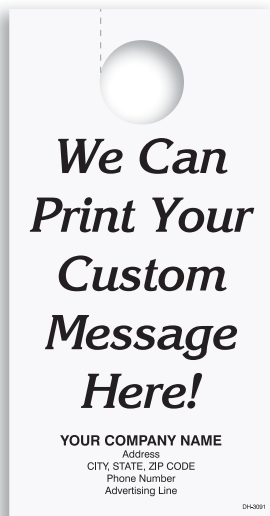

DH-3091
Custom Door Hanger
Imprint area 5" x 3 1/2"

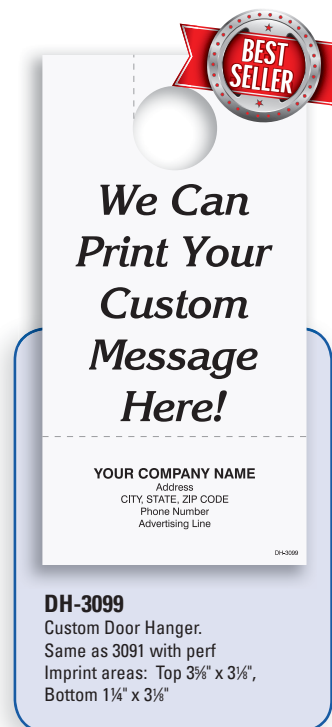

DH-3099
Custom Door Hanger.
Same as 3091 with perf
Imprint areas: Top 3 3/8" x 3 1/8",
Bottom 1 1/4" x 3 1/8"

3 2/3" x 7" Door Hanger

Cat. No.	Message	Wt. per 1000	Lot Prices				
			500	1000	2000	3000	5000
3091	Custom Also Formats 3093, 3094	6#	83.99	116.22	180.03	267.75	439.29
3099	Custom with Perf Also Formats 3090, 3097, 3098	6#	83.99	116.22	180.03	267.75	439.29

Add Jumbo Numbering: 500 - \$31.22
1000 - \$62.42

(R)

NOTE:

Additional PMS Ink Colors

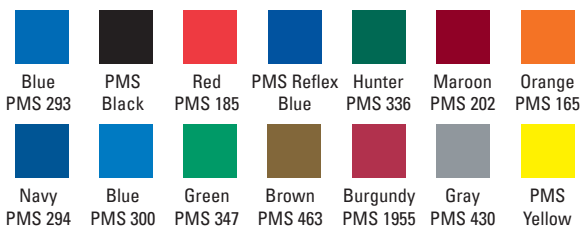

Color other than black \$31.24
2-Color Combo \$64.45
Proof \$15.66
Colors shown are approximate. (R)

Stock

100# White Tag



Includes your company's name, address and phone number in one of four colors! For blank forms, subtract 30% unless otherwise listed.



- Choose from one of our standard formats or submit your custom copy.
- Back printing available on most door hangers for an additional charge.



Format-3093
Sorry We Missed You Door Hanger
Imprint area 1" x 3 1/2"

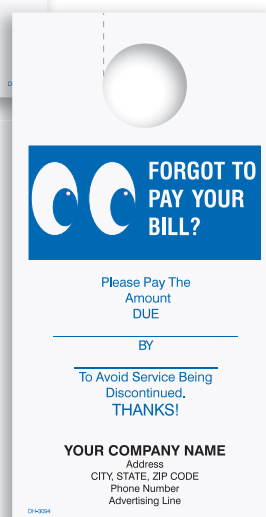

Format-3094
Utility Door Hanger
Imprint area 1" x 3 1/2"



A Blank Tags - Colored
 CSU - 513X - Size 5, 2 $\frac{3}{8}$ " x 4 $\frac{3}{4}$ "
 CSU - 813X - Size 8, 3 $\frac{1}{8}$ " x 6 $\frac{1}{4}$ "
Order by size and color.
 Replace "X" in Cat. No. with the number that corresponds with your choice of color.

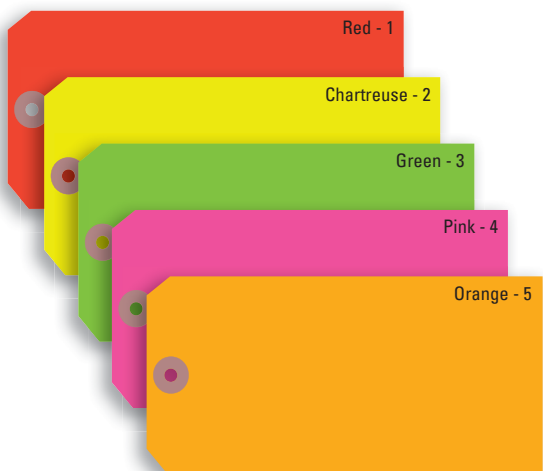

C Blank Tags - Fluorescent Colored
 FCSU - 539X - Size 5, 2 $\frac{3}{8}$ " x 4 $\frac{3}{4}$ "
 FCSU - 839X - Size 8, 3 $\frac{1}{8}$ " x 6 $\frac{1}{4}$ "
Order by size and color.
 Replace "X" in Cat. No. with the number that corresponds with your choice of color.

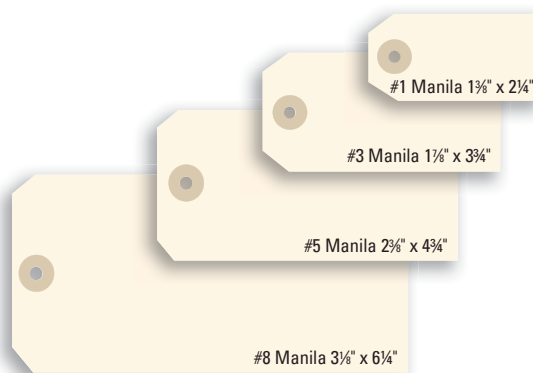

B Blank Tags - Manila
 SU-1131, 3131, 5131, 8131

A Blank Tags - Colored

Cat. No.	Size	Color	Wt. per 1000	Stock Lot Prices			
				1000	5000	10000	
513X	5	—	6#	61.81	102.91	231.95	412.68
813X	8	—	10#	85.18	142.18	284.73	567.89

Available imprinted and numbered. (R)

B Blank Tags - Manila

Cat. No.	SU-	Size	Color	Wt. per 1000	Stock Lot Prices		
					1000	5000	10000
1131	1	Manila	4#	33.58	58.89	125.41	223.95
3131	3	Manila	4#	37.59	62.79	141.64	253.15
5131*	5	Manila	6#	43.10	72.30	162.51	288.62
8131*	8	Manila	10#	53.27	88.42	199.39	355.36

*Available imprinted and numbered size 5 & 8. Cannot imprint on size 1 & 3. (R)

C Blank Tags - Fluorescent Colored

Cat. No.	FCSU-	Size	Color	Wt. per 1000	Stock Lot Prices		
					1000	5000	10000
539X	5	—	6#	77.17	128.66	289.92	515.87
839X	8	—	10#	106.48	177.76	356.01	709.91

Available imprinted and numbered. (R)

D Tag Connectors*

Cat. No.	Description	Price per 1000
1209	Twine - Cut String - 12", No.9 Gauge	19.09
1226	Loose Wire - 12", No.26 Gauge	12.93

*Image not shown. (R)

NOTE:

#5 & #8 Tags	1000	2000	5000	10000
330036 Imprint charge	76.62	148.73	360.14	699.10
330037 Number charge	76.62	148.73	360.14	699.10
330038 String charge	21.90	42.61	103.15	199.81

#5 & #8 colored or manila tags can be crash imprinted & numbered. (R)
 Black ink standard.
 Colors other than black \$31.24(R)
 Four-color process \$31.24 per thousand (R)
 5 days shipping.

4-Color Process Available!



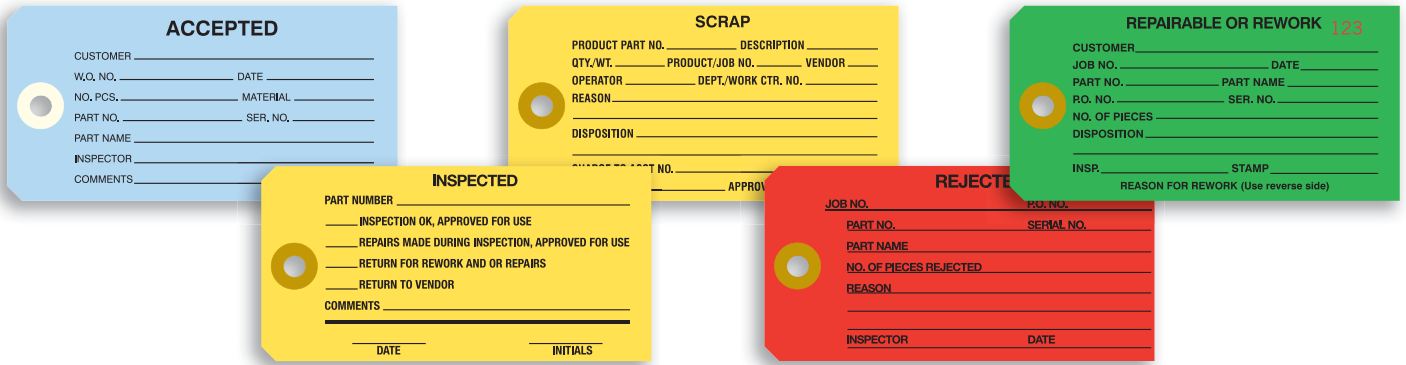

E PT-165, PTS-165 (w/string), PTW-165 (w/wire)
2 3/4" x 4 3/4"

E PT-165, PTS-165, PTW-165 - Work Order Tags						
Cat. No.	Description	Wt. per 1000	Blank Lot Prices			
PT-			1000	2000	5000	10000
165-1	Accepted	5#	63.65	105.94	238.87	425.01
165-2	Scrap	5#	63.65	105.94	238.87	425.01
165-3	Inspected	5#	63.65	105.94	238.87	425.01
165-4	Rejected	5#	63.65	105.94	238.87	425.01
165-5	Repairable	5#	63.65	105.94	238.87	425.01
PTS- (with string)			Blank Lot Prices			
165-1	Accepted	6#	82.69	144.12	334.16	615.59
165-2	Scrap	6#	82.69	144.12	334.16	615.59
165-3	Inspected	6#	82.69	144.12	334.16	615.59
165-4	Rejected	6#	82.69	144.12	334.16	615.59
165-5	Repairable	6#	82.69	144.12	334.16	615.59
PTW- (with wire)			Blank Lot Prices			
165-1	Accepted	6#	83.34	145.31	337.41	621.97
165-2	Scrap	6#	83.34	145.31	337.41	621.97
165-3	Inspected	6#	83.34	145.31	337.41	621.97
165-4	Rejected	6#	83.34	145.31	337.41	621.97
165-5	Repairable	6#	83.34	145.31	337.41	621.97

Not available imprinted. (R)

F STR-317 - Tag
Repair Tag, 3 1/2" x 6 1/4"
Imprint area 1" x 3"

F STR-317 - Repair Tag						
Cat. No.	Pts.	Wt. per 1000	Carbonless Lot Prices			
STR-			500	1000	2000	5000
317-2	2	10#	108.75	169.87	272.08	565.19
317-3	3	12#	135.90	206.75	331.89	715.53

Pre-strung. Black ink only. Mylar reinforced back. (R)

G STR-307 - Repair Tag							
Cat. No.	Pts.	Wt. per 1000	Stock Lot Prices				
STR-			500	1000	2000	3000	5000
307-1	1	8#	95.99	154.94	253.69	333.30	544.64

Pre-strung. Black ink only. Mylar reinforced back. (R)

G STR-307 - Tag
Repair Tag, 3 1/2" x 5 1/2"
Imprint area 3/4" x 2 3/4"

NOTE:



Includes your company's name, address and phone number in one of four colors! For blank forms, subtract 30% unless otherwise listed.



- ! We also offer Valet Parking Tags. See page 34.
- ! Back of STR-317 and STR-307 are reinforced with mylar.



Three Part

STR-302-1 REPAIR TAG
PRINTED IN U.S.A.

A 37423

YOUR COMPANY NAME
CITY, STATE, ZIP CODE
Address
Phone Number
Advertising Line

CUSTOMER	INV. NO. A 37423
ADDRESS	PHONE
MODEL	SER. NO.
PROBLEM:	REC'D.
	PROMISED

PARTS AND WORK PERFORMED

AMOUNT
PARTS
LABOR
TAX
TOTAL

SPECIAL INSTRUCTIONS

REC'D. BY _____

Thank you! CASH ON COMPLETION OF WORK

STR-305-2 REPAIR TAG
PRINTED IN U.S.A.

P 03183

YOUR COMPANY NAME
CITY, STATE, ZIP CODE
Address
Phone Number
Advertising Line

CUSTOMER	INV. NO. P 03183
ADDRESS	PHONE
MODEL	SER. NO.
PROBLEM:	REC'D.
	PROMISED

PARTS AND WORK PERFORMED

AMOUNT
PARTS
LABOR
TAX
TOTAL

SPECIAL INSTRUCTIONS

REC'D. BY _____

Thank you! CASH ON COMPLETION OF WORK

STR-301-1 REPAIR TAG
PRINTED IN U.S.A.

M 03303

YOUR COMPANY NAME
CITY, STATE, ZIP CODE
Address
Phone Number
Advertising Line

CUSTOMER	INV. NO. M 03303
ADDRESS	PHONE
MODEL	SER. NO.
PROBLEM:	REC'D.
	PROMISED

PARTS AND WORK PERFORMED

AMOUNT
PARTS
LABOR
TAX
TOTAL

SPECIAL INSTRUCTIONS

REC'D. BY _____

Thank you! CASH ON COMPLETION OF WORK

Two Part

STR-302-1 REPAIR TAG
PRINTED IN U.S.A.

A 37423

YOUR COMPANY NAME
CITY, STATE, ZIP CODE
Address
Phone Number
Advertising Line

CUSTOMER	INV. NO. A 37423
ADDRESS	PHONE
MODEL	SER. NO.
PROBLEM:	REC'D.
	PROMISED

PARTS AND WORK PERFORMED

AMOUNT
PARTS
LABOR
TAX
TOTAL

SPECIAL INSTRUCTIONS

REC'D. BY _____

Thank you! CASH ON COMPLETION OF WORK

Two Part

STR-302-1 REPAIR TAG
PRINTED IN U.S.A.

A 37423

YOUR COMPANY NAME
CITY, STATE, ZIP CODE
Address
Phone Number
Advertising Line

CUSTOMER	INV. NO. A 37423
ADDRESS	PHONE
MODEL	SER. NO.
PROBLEM:	REC'D.
	PROMISED

PARTS AND WORK PERFORMED

AMOUNT
PARTS
LABOR
TAX
TOTAL

SPECIAL INSTRUCTIONS

REC'D. BY _____

Thank you! CASH ON COMPLETION OF WORK

STR-305-2 REPAIR TAG
PRINTED IN U.S.A.

A 37423

YOUR COMPANY NAME
CITY, STATE, ZIP CODE
Address
Phone Number
Advertising Line

CUSTOMER	INV. NO. A 37423
ADDRESS	PHONE
MODEL	SER. NO.
PROBLEM:	REC'D.
	PROMISED

PARTS AND WORK PERFORMED

AMOUNT
PARTS
LABOR
TAX
TOTAL

SPECIAL INSTRUCTIONS

REC'D. BY _____

Thank you! CASH ON COMPLETION OF WORK

STR-301-1 REPAIR TAG
PRINTED IN U.S.A.

M 03303

YOUR COMPANY NAME
CITY, STATE, ZIP CODE
Address
Phone Number
Advertising Line

CUSTOMER	INV. NO. M 03303
ADDRESS	PHONE
MODEL	SER. NO.
PROBLEM:	REC'D.
	PROMISED

PARTS AND WORK PERFORMED

AMOUNT
PARTS
LABOR
TAX
TOTAL

SPECIAL INSTRUCTIONS

REC'D. BY _____

Thank you! CASH ON COMPLETION OF WORK

One Part

A STR-302, STC-305, STB-301 - Tag
Repair Tag, 3 1/8" x 9"
Imprint area 3/4" x 2 3/4"

LAY-AWAY TICKET NO.

Date _____ **01786**

Name _____
Address _____
Article _____ Sold by _____
Retail Price _____ Tax _____ Total _____

TICKET NO. **01786**

Name _____
Address _____
Article _____ Clerk No. _____

PAYMENTS MADE				
Date	Sales Slip Number	Amount	Balance	Rec'd By

CUSTOMER'S IDENTIFICATION STUB
LAY-AWAY TICKET NO. **01786**

This stub is to be retained until final payment is made and surrendered upon receipt of merchandise. If merchandise is not fully paid for and called for on or before _____ it will be returned to stock unless special arrangements are made.

SOLD BY _____ 613

REPAIR TAG Form 653

No. **04516** Date _____

Owner _____
Address _____
Promised _____

REPAIRS	CHARGES

AMT. DUE _____

No. **04516** Promised
CLAIM CHECK
ALL ITEMS CASH

NO WORK DELIVERED WITHOUT THIS CHECK
If Goods Are Not Called For In 30 Days They Will Be Sold For Charges.

A STR-302, STC-305, STB-301 - Repair Tag

Cat. No.	Color	Pts.	Wt. per 1000	Lot Prices				
				500	1000	2000	3000	5000
STR-302-1	Salmon	1	16#	136.66	216.37	410.41	583.69	919.52
Carbon Lot Prices								
STR-302-3	Salmon	3	20#	203.07	352.98	637.86	950.02	1,553.99
STC-305-2	Yellow	2	18#	188.14	323.78	588.66	861.98	1,397.37
STB-301-2	Blue	2	18#	188.14	323.78	588.66	861.98	1,397.37

Pre-strung. Black ink only. No choice of starting number. (R)

B TL-3509 - Layaway Tag

Cat. No.	Pts.	Wt. per 1000	Stock Lot Prices			
			500	1000	2000	5000
3509	1	11#	156.13	234.00	350.93	584.44

Pre-strung. Not available imprinted. No choice of starting number. (R)

C TR-3510 - Repair Tag

Cat. No.	Pts.	Wt. per 1000	Stock Lot Prices			
			500	1000	2000	5000
3510	1	8#	135.79	249.15	373.42	622.41

Pre-strung. Not available imprinted. No choice of starting number. (R)

NOTE:

Company Imprint

Includes your company's name, address and phone number in one of four colors! For blank forms, subtract 30% unless otherwise listed.



We also offer Work Order forms. See pages 46 - 49.

Backer

D **STWCC-323 - Tag**
Inventory Tag, 3 1/8" x 6 1/4"

E **STW-343 - Tag**
Inventory Tag, 3 1/8" x 6 1/4"

Backer

F **STWCC-313 - Tag**
Manila Inventory Tag, 3 3/8" x 6 3/4"

D **STWCC-323 - Inventory Tag**

Cat. No.	Wt.		Carbonless Lot Prices			
STWCC-	Pts.	per 1000	500	1000	2000	5000
323-2	2	8#	155.16	234.98	359.25	598.29

Not available imprinted. No choice of starting number. (R)

E **STW-343 - Inventory Tag**

Cat. No.	Wt.		Carbon Lot Prices			
STW-	Pts.	per 1000	500	1000	2000	5000
343-3	3	10#	170.62	258.45	395.16	333.62

Not available imprinted. No choice of starting number. (R)

F **STWCC-313 - Inventory Tag**

Cat. No.	Wt.		Carbonless Lot Prices			
STWCC-	Pts.	per 1000	500	1000	2000	5000
313-2	2	10#	155.16	234.98	359.25	598.29

Not available imprinted. (R)
Numbering charge for specific starting number. \$54.69(R) per M.

G **TI-3513 - Inventory Tag**

Cat. No.	Wt.		Stock Lot Prices			
TI-	Pts.	per 1000	500	1000	2000	5000
3513	1	9#	88.64	133.09	226.22	480.83

Pre-Strung. Not available imprinted. No choice of starting number. (R)

G **TI-3513 - Tag**
Manila Inventory Tag, 3 3/8" x 6 3/4"

A

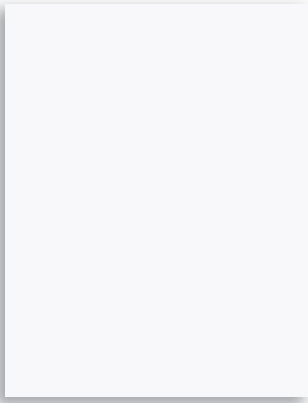

353391 & 393391
8½" x 11" with back score
Compatible with Avery #5165

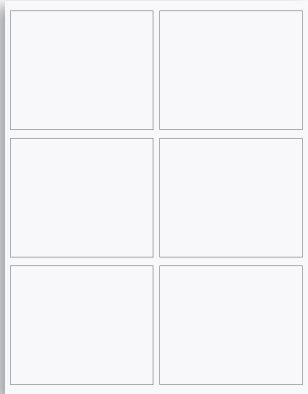

353393 & 393393
Label size 4" x 3½"
Compatible with Avery #5164

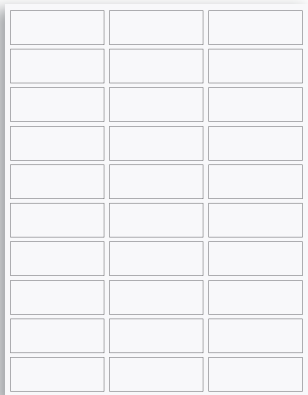

353397 & 393397
Label size 2¾" x 1"
Compatible with Avery #5160

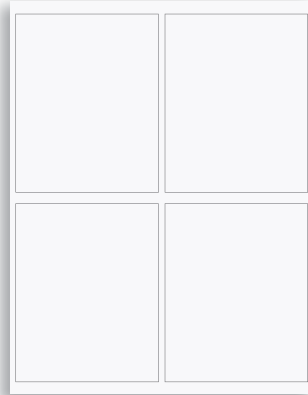

353392 & 393392
Label size 4" x 5"

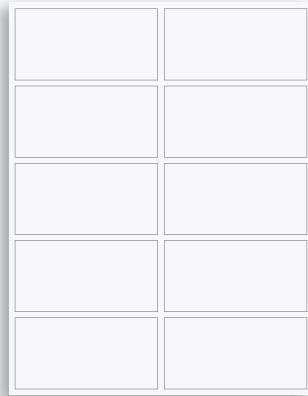

353394 & 393394
Label size 4" x 2"
Compatible with Avery #5163



4-color process is available for an additional charge per 100 sheets on Item A.

Additional charge:

100 sheets	200 sheets	300 sheets	400 sheets
43.76	80.80	117.59	148.62 ^(R)

Imprint size:
393391 - 8" x 10½"
393392 - 3¾" x 4⅞"
393393 - 3¾" x 3"
393394 - 3¾" x 1⅞"
393397 - 2½" x ⅞"

A Pressure Sensitive Shipping Labels

Cat. No.	Labels per Sheet	Wt. per 100 Sheets	Imprinted Lot Prices			
			100 Sheets	200 Sheets	300 Sheets	400 Sheets
393391	1	3#	106.38	150.94	188.69	229.79
393392	4	3#	106.38	150.94	188.69	229.79
393393	6	3#	106.38	150.94	188.69	229.79
393394	10	3#	106.38	150.94	188.69	229.79
393397	30	3#	106.38	150.94	188.69	229.79
Blank Lot Prices						
353391	1	3#	40.51	80.20	106.70	139.47
353392	4	3#	40.51	80.20	106.70	139.47
353393	6	3#	40.51	80.20	106.70	139.47
353394	10	3#	40.51	80.20	106.70	139.47
353397	30	3#	40.51	80.20	106.70	139.47

50# Laser Label stock (premium white) with no ooze permanent adhesive. ^(R)
100 label sheets per box.
No bleeds available. Sheet size 8½" x 11".
4-color process available.

0108 Pressure Sensitive Shipping Labels

Label 4" x 3 1/2"
Imprint Area 7/8" x 3"



Format A



Format 0101

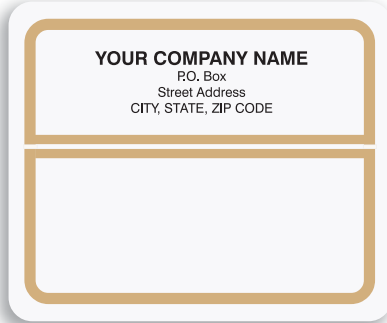

Format 0102

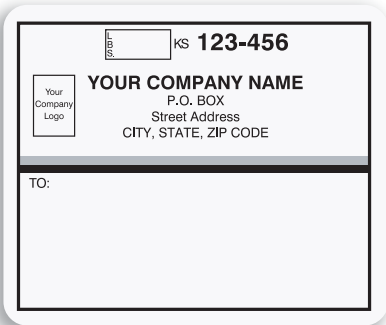

Format B

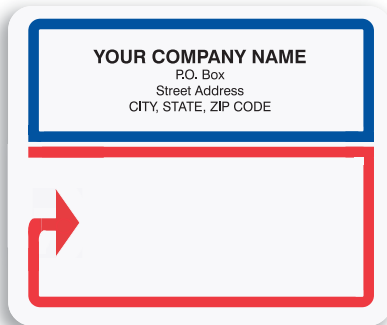

Format 0103



Format 1171

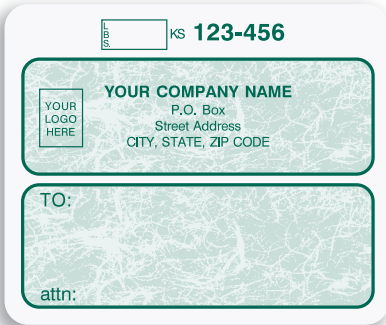

Format C



Format 1181

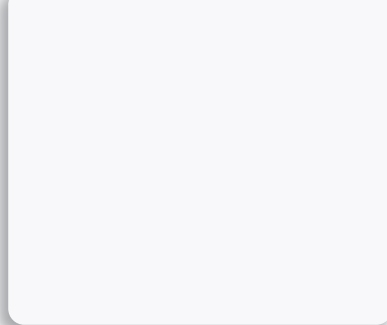

Format 1191 - Custom
Imprint Size 3 1/2" x 3"

Cat. No.	Labels		Lot Prices			
	Sheet	Wt. per 100 Sheets	100 Sheets	200 Sheets	300 Sheets	400 Sheets
0108	6	3#	106.38	150.94	188.69	229.79

2-color ink charge \$64.45(R) additional. (R)
*See page 117 for ink color selections for Format 1191.

NOTE:



Includes your company's name, address and phone number in one of four colors!
For blank forms, subtract 30% unless otherwise listed.



! For Shipping Forms, see pages 70-73.



Format D

Gift Certificates

A GC-784 - Wrap-Around Book
 Gift Certificate, 8½" x 3½"
 Imprint area ¾" x 3½"
 7" x 8½" overall



B GCD-784
Gift Certificate Display
 8½" x 11"



C GC-779 - 4-color Gift Certificates
 Gift Certificate, 7¼" x 3¼"
 Printed on 100lb white cover stock

Send your custom artwork or choose one of our predesigned formats.



FREE when you order items A or C

A GC-784 - Gift Certificate Book

Cat. No.	GCD- Pts.	Wt. per 5 Bks	Carbonless Lot Prices			20 Bks
			5 Bks	10 Bks	15 Bks	
784-3	3	12#	158.83	255.96	349.84	431.50

100 Gift Certificates, 50 sheet sets. Envelopes included. (R)

B GCD-784 - Gift Certificate Display

Cat. No.	GCD- each	Wt.	Price
784-5	2#		27.21

(R)

C GC-779 - 4-Color Gift Certificate

Cat. No.	GC- Pts.	Wt. per 250	Imprinted Lot Prices			1000
			100	250	500	
779-1	1	5#	78.31	105.67	140.99	202.64
779-2	2	5#	105.35	141.69	200.42	305.39

Full bleeds available for an additional charge of \$34.70. Specify custom artwork or format choice when ordering. 2-part is white/canary. Envelopes included. (R)

NOTE:



Includes your company's name, address and phone number in one of four colors! For blank forms, subtract 30% unless otherwise listed.



Colors correspond to sequence and number of parts selected in your order unless otherwise specified.



Choose a six-digit number for your imprinted form, or seven-digit for all register forms at no extra charge! Otherwise, we will start with 001001 or 0001001. Four, five and custom seven-digit numbering available at an additional charge. See page 142 for pricing.



Blank forms will be sequentially numbered unless specified otherwise.

FREE when you order items D or E



Envelopes



Counter Top Sign

Keep all your certificates together by binding 50 in a book with a wrap-around cover for a slight additional charge of \$11.65(R) per 1000.



D GC-780-783, GC-785-788 - Snap-A-Part
Gift Certificates, 8½" x 3½"
Imprint area 1" x 4"

D GC-780-783, GC-785-788 - Gift Certificates

Cat. No.	GC- Color	Pts.	Wt. per 250	Carbonless Lot Prices				
				Marble Background Colors				
				250	500	1000	2000	3000
780-2	Blue	2	5#	89.39	130.39	214.21	385.86	556.54
781-2	Red	2	5#	89.39	130.39	214.21	385.86	556.54
782-2	Green	2	5#	89.39	130.39	214.21	385.86	556.54
783-2	Orange	2	5#	89.39	130.39	214.21	385.86	556.54
Screened Background Colors								
785-2	Blue	2	5#	89.39	130.39	214.21	385.86	556.54
786-2	Red	2	5#	89.39	130.39	214.21	385.86	556.54
787-2	Green	2	5#	89.39	130.39	214.21	385.86	556.54
788-2	Orange	2	5#	89.39	130.39	214.21	385.86	556.54

(R)

E GC-790-793 - Gift Certificate Book

Cat. No.	GC- Color	Pts.	Wt. per 2 Bks	Imprinted Carbonless Lot Prices				
				2(300)	4(600)	6(900)	8(1200)	10(1500)
790-2	Blue	2	4#	119.68	227.84	323.89	409.76	483.85
791-2	Red	2	4#	119.68	227.84	323.89	409.76	483.85
792-2	Green	2	4#	119.68	227.84	323.89	409.76	483.85
793-2	Balloons	2	4#	119.68	227.84	323.89	409.76	483.85
Blank Carbonless Lot Prices								
Blank	Blank	2	4#	104.97	199.83	284.84	359.69	424.47

(R)

NOTE:

Available background options (Item E)

Select from 3 background colors or balloon pattern for gift certificates.



E GC-790-793 - Wire Bound Book
Gift Certificate, 8½" x 11" overall
Certificate size 8½" x 3½"
Imprint area 1" x 4"
150 certificates per book

Calendars & Sticky Notes

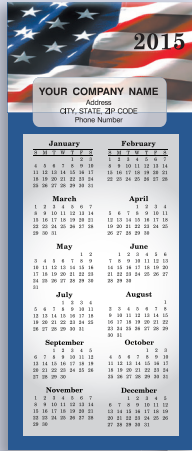

A 491275, 491276
Card Calendar, 3½" x 8½"
491275: 4-color/blank
491276: 4-color/black



B 491277
Card Calendar with magnetic back, 8½" x 3½"
4 color

Available with or without the calendar, you choose what you want printed. Just send your artwork and we'll take care of the rest!



B 491277
Card Calendar with magnetic back, 8½" x 3½"
4 color



C Sticky Notes™
4" x 3" pads
Imprint area 3" x 4"



Add color with a FREE flood coat!



D Sticky Notes™
3" x 3" pads
Imprint area 3" x 3"



E Sticky Notes™
3" x 8" pads
Imprint area 8" x 3"

Add a magnet to the back of your 3" x 8" notepad for the ultimate convenience! \$.52(R) additional per pad.



A Card Calendars

Cat. No.	per 1000	Price Per Piece				
		Wt. 50	100	200	500	1000
491275	9#	1.77	1.35	1.25	1.04	0.83
491276	9#	1.77	1.35	1.25	1.04	0.83

B Card Calendars with Magnet

Cat. No.	per 1000	Price Per Piece				
		Wt. 40#	50	100	200	500
491277	40#	3.43	2.60	2.08	1.56	1.35

C Bic® Sticky Notes™

Item Number	Size	Wt. per 500 Pads	Pages per Pad	500 per Pad
P4A3A25	4" x 3"	22#	25	0.68
P4A3A50	4" x 3"	44#	50	1.20

Adhesive is on the 4" side.

D Bic® Sticky Notes™

Item Number	Size	Wt. per 500 Pads	Pages per Pad	500 per Pad
P3A3A25	3" x 3"	16#	25	0.68
P3A3A50	3" x 3"	32#	50	1.20

E Bic® Sticky Notes™

Item Number	Size	Wt. per 500 Pads	Pages per Pad	500 per Pad
P3A8A25	3" x 8"	44#	25	1.66
P3A8A50	3" x 8"	56#	50	3.17

Adhesive is on the 3" side.

Minimum Quantity: 500
Paper Colors: White (Add color with a FREE flood coat.)
Imprint Colors: Black, Red, Yellow, Orange, Light Orange, Navy, Reflex Blue, Blue, Royal, Purple, Plum, Burgundy, Lime, Green, Teal, Forest Green, Magenta, Brown, Cyan, Warm Gray.
Price includes a 4-color process imprint. Converting 4-color process will not guarantee a perfect match to spot color.
Specifications: Text can be as small as 6 point type. Lines must be 0.5 point thick. Floodcoat 10-30% tint recommended. Phantom - 10% tints work best.

- No setup charges.
- No additional charge for phantom (ghost) imprints, flood coating or bleeds.
- Change the paper color on one side by printing a flood coat.

Submit your layout for Custom Punch Cards!

These are great for:

- Beauty Shops & Spas
- Coffee Shops
- Restaurants
- Video/DVD Rentals
- Insurance Agencies
- Pet Stores
- And more...

A 3½" x 2" Punch Cards

Cat. No.	DC-	Pts.	Wt. per 1000	Lot Prices - Black Ink	
				500	1000
4601		1	3#	46.24	50.67

Black ink is standard. Other colors are available at an upcharge. (R)
 Back printing available for \$33.57(R).
 Printed on 65# White Accent Opaque Card Stock.
 Bleeds available.
 4-color is available for additional charge. 500=\$31.21, 1000=\$62.42 (R).

B Note Pads - 100 Sheets

Cat. No.	NP-	Size	Wt. per 8 Pads	Lot Prices				
				8	16	32	64	128
2000		2¾" x 4¼"	2#	81.17	108.86	167.27	218.75	367.15
2200		4¼" x 5½"	3#	96.53	129.20	218.00	259.53	414.09
2400		5½" x 8½"	5#	114.70	144.77	262.02	425.66	662.53

No bleeds available. (R)

C Note Pads - 50 Sheets

Cat. No.	NP-	Size	Wt. per 8 Pads	Lot Prices				
				8	16	32	64	128
2100		2¾" x 4¼"	1#	59.54	80.20	134.93	160.78	271.10
2300		4¼" x 5½"	2#	71.12	95.45	160.35	191.28	319.99
2500		5½" x 8½"	3#	84.64	106.70	193.55	313.61	489.26

No bleeds available. (R)

NOTE:

Additional PMS Ink Colors

Blue PMS 293	Black PMS Black	Red PMS 185	PMS Reflex Blue	Hunter PMS 336	Maroon PMS 202	Orange PMS 165
Navy PMS 294	Blue PMS 300	Green PMS 347	Brown PMS 463	Burgundy PMS 1955	Gray PMS 430	PMS Yellow

Color other than black \$31.24
 2-Color Combo \$64.45
 Proof \$15.66
 Colors shown are approximate. (R)



Includes your company's name, address and phone number in one of four colors! For blank forms, subtract 30% unless otherwise listed.

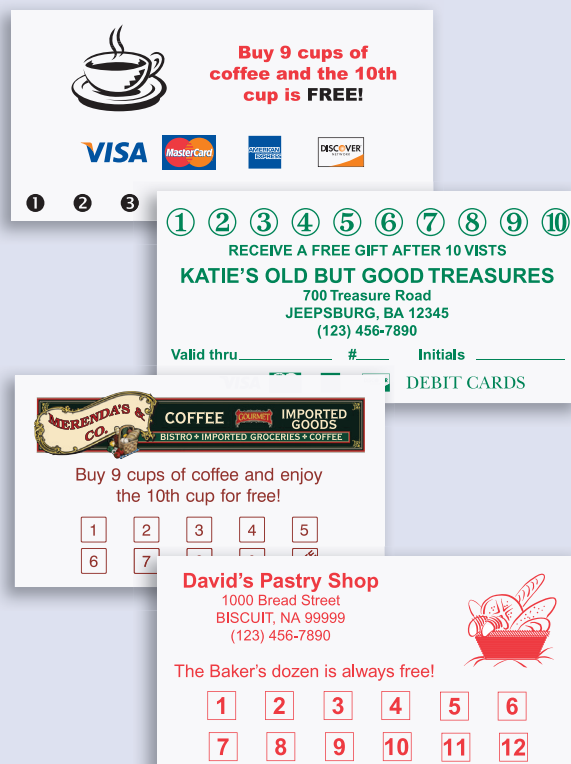

A Punch Cards

3½" x 2"
 Imprint area 1½" x 3"



B Note Pads
 100 sheets per pad

C Note Pads
 50 sheets per pad

Writing Instruments



BIC® Grip Roller



BIC® Grip Roller Gold



BIC® Pivo®



BIC® Mark-It™



BIC® Brite Liner Grip®

BIC® Grip Roller & Grip Roller Gold Pens

Item Number	Description	Price Per Piece	
		300	500+
GR	Grip Roller	1.37	1.34
GRG	Grip Roller Gold	1.65	1.62

(R)

Ink Colors: Black or Blue - Fine Point.

Pen Colors: White, Navy, Light Gray, Forest Green, Charcoal, Burgundy, Black, (Red & Blue on GR). All pens have black grip.

Imprint Colors: White, Black, Yellow, Navy, Pink, Red, Burgundy, Purple, Teal, Reflex Blue, Process Blue, Maroon, Green, Orange, Charcoal, Brown, Forest Green, Cream, Metallic Silver (except on white barrel).

Imprint Area: 1½" x ⅝" Cap or Barrel.

Choose barrel or cap imprint. If not specified, imprint will be on cap.

Price includes 1-color imprint on cap or barrel. Second color add \$.15(R) per piece.

BIC® Pivo® Twist Action Pens

Item Number	Description	Price Per Piece	
		300	500+
TWP	Pivo®	1.06	1.04

(R)

Ink Colors: Blue or Black. Available in Medium or Fine Point.

Pen Colors: White, Black, Navy, Forest Green, Red, Teal, Purple, Yellow, Burgundy, Blue.

Ring Colors: Black, White, Navy, Red, Yellow, Forest Green, Blue, Burgundy, Teal, Purple. Choose 1 pen & 1 ring color.

Imprint Colors: Black, Brown, Burgundy, Charcoal, Green, Maroon, Navy, Orange, Forest Green, Pink, Process Blue, Purple, Red, Reflex Blue, Teal, White, Yellow, Cream, Metallic Gold, Metallic Silver, Metallic Blue, Metallic Copper, Metallic Green, Metallic Magenta.

Imprint Area: 2" x ¾"

Price includes 1-color imprint on cap or barrel. Second color add \$.15(R) per piece.

Clip Imprint Area: 1" x ⅝"

Add \$.15(R) per piece for clip imprint.

BIC® Mark-It™ Permanent Marker

Item Number	Description	Price Per Piece	
		300	500+
MRPG	Mark-It™ Permanent Marker	1.74	1.60

(R)

Ink Colors: Black or Blue - Fine Point.

Trim/Grip Colors: Black or Blue.

Barrel Colors: White only.

Imprint Colors: Black, Brown, Burgundy, Charcoal, Green, Maroon, Navy, Orange, Forest Green, Pink, Process Blue, Purple, Red, Reflex Blue, Teal, White, Yellow, Cream, Metallic Gold, Metallic Silver, Metallic Blue, Metallic Copper, Metallic Green, Metallic Magenta.

Imprint Area: 1½" x ⅝" Cap or Barrel.

Choose barrel or cap imprint. If not specified, imprint will be on cap.

Price includes 1-color imprint on cap or barrel. Up to 4 colors available on any cap/barrel combination. Add \$.15(R) per marker for each color in second location.

BIC® Brite Liner Grip®

Item Number	Description	Price Per Piece	
		300	500+
BLG	Brite Liner Grip®	1.40	1.28

(R)

Barrel Colors with Matching Ink: Yellow, Pink, Green, Orange, Blue.

All include textured, gray rubber grip & matching clip.

Imprint Colors: Black, Brown, Burgundy, Charcoal, Green, Maroon, Navy, Orange, Forest Green, Pink, Process Blue, Purple, Red, Reflex Blue, Teal, White, Yellow, Cream, Metallic Gold, Metallic Silver, Metallic Blue, Metallic Copper, Metallic Green, Metallic Magenta.

Imprint Area: 1½" x ⅝" Cap or Barrel.

Choose barrel or cap imprint. If not specified, imprint will be on cap. Price includes 1-color imprint on cap or barrel. Second color add \$.15(R) per piece.

BIC® Clic Stic® & Clic Stic® Grip Pens

Item Number	Description	Price Per Piece	
		300	500+
CS	Clic Stic®	0.82	0.79
CSCG	Clic Stic® Grip	1.27	1.22

(R)

Ink Colors: Blue, Black or Red - Medium Point, Black or Blue - Fine Point.

CS **Barrel/Trim Colors:** Clear, Purple, Teal, Red, Black, Silver, Burgundy, Navy, Cream, Blue, Forest Green, Yellow, White, Green, Orange, Pink, Metallic Dark Blue, Metallic Red, Metallic Green, Metallic Brown, Metallic Orange, Metallic Sand.

Barrel Imprint Area: 2 1/8" x 3/4"

CSCG **Barrel Colors:** White Only.

Trim Colors: Black, Blue, Forest Green, Purple, Red, Navy, Pink, Burgundy, Yellow.

Barrel Imprint Area: 1 3/4" x 1/2"

Imprint Colors: Black, Brown, Burgundy, Charcoal, Green, Maroon, Navy, Orange, Forest Green, Pink, Process Blue, Purple, Red, Reflex Blue, Teal, White, Yellow, Cream, Metallic Gold, Metallic Silver, Metallic Blue, Metallic Copper, Metallic Green, Metallic Magenta.

Choose 1 barrel & 1 trim color.

Price includes a 1-color imprint on barrel. Second color add \$.15(R) per piece.

Clip Imprint Area: 1 1/8" x 5/32" Add \$.15(R) per piece for clip imprint.

BIC® Widebody Grip® & Widebody Grip® Color Pens

Item Number	Description	Price Per Piece	
		300	500+
CSWBG	Widebody Grip®	1.74	1.61
CSWBCG	Widebody Grip® Color	1.74	1.61

(R)

Ink Colors: Blue, Black or Red - Medium Point, Blue or Black - Fine Point.

CSWBCG **Barrel Color:** White Only.

Grip and Trim: Black, Purple, Yellow, Red, Blue, Forest Green, Orange, Pink, Navy, Burgundy (Grip and Trim must be the same color).

CSWBG **Barrel/Trim Colors:** Silver (Barrel only), Black, White, Navy, Cream, Yellow, Teal, Blue, Red, Forest Green, Purple, Burgundy.

Grip: Black Only.

Choose 1 barrel & 1 trim color.

Imprint Colors: Black, Brown, Burgundy, Charcoal, Green, Maroon, Navy, Orange, Forest Green, Pink, Process Blue, Purple, Red, Reflex Blue, Teal, White, Yellow, Cream, Metallic Gold, Metallic Silver, Metallic Blue, Metallic Copper, Metallic Green, Metallic Magenta.

Barrel Imprint Areas:

Option 1: 2 1/8" x 5/8" Barrel imprint on opposite side of clip.

Option 2: 1 1/8" x 1" Barrel imprint aligned with clip, when there is a clip imprint.

Price includes 1-color imprint on barrel. Second color add \$.15(R) per piece.

Clip Imprint Area: 3/4" x 5/32" Add \$.15(R) per piece for clip imprint.

BIC® Velocity® Gel

Item Number	Description	Price Per Piece		
		150	300	500+
VGEL	Velocity® Gel	2.54	2.37	2.20

(R)

Barrel Colors: Black or Blue.

Barrel matches the ink color.

Ink Colors: Black or Blue Gel Ink - Medium Point.

Barrel Imprint Area: 1 3/4" x 7/16" Add \$.15(R) per piece for a second color.

Imprint Colors: Black, Brown, Burgundy, Charcoal, Green, Maroon, Navy, Orange, Forest Green, Pink, Process Blue, Purple, Red, Reflex Blue, Teal, White, Yellow, Cream, Metallic Gold, Metallic Silver, Metallic Blue, Metallic Copper, Metallic Green, Metallic Magenta.

Price includes 1-color imprint on barrel.

NOTE:



! Allow 3 extra days for proof.



BIC® Clic Stic®



BIC® Clic Stic® Grip



BIC® Widebody Grip®



BIC® Widebody Grip® Color



BIC® Velocity® Gel

Writing Instruments



BIC® Style®



BIC® Style® Clear



BIC® Protrusion Grip™



BIC® Pencil Solid



BIC® Media Clic™ Grip



BIC® Media Clic™

BIC® Style® & Style® Clear

Item Number	Discription	Price Per Piece	
		500+	
STYL	Style®	0.49	
STYLCL	Style® Clear	0.54	

(R)

Ink Colors: Black ink - Medium Ballpoint.

Colors:

STYL Cap Colors: Black, Blue, Green, Red. All include a white barrel.

STYLCL Pen Colors: Blue, Green, Purple, Red. Cap matches barrel color.

Imprint Area: Barrel: 2¼" x ¾"

Imprint Colors: Black, Brown, Burgundy, Charcoal, Green, Maroon, Navy, Orange, Forest Green, Pink, Process Blue, Purple, Red, Reflex Blue, Teal, White, Yellow, Cream, Metallic Gold, Metallic Silver, Metallic Blue, Metallic Copper, Metallic Green, Metallic Magenta.

Note: Price includes a 1-color imprint on barrel. Second color add \$.15(R) per piece.

BIC® Protrusion Grip™

Item Number	Discription	Price Per Piece	
		50	250+
PG	Protrusion Grip™	7.41	7.29

(R)

Ink Colors: Black ink - Medium Ballpoint.

Barrel Colors: Copper, Black, Blue, Silver. All include polished chrome plated trim and clip.

Imprint Area: Barrel Screen Printing: 1½" x ½", opposite clip.

Screen printing price includes 1 color barrel imprint.

Imprint Colors: Black, Brown, Burgundy, Charcoal, Green, Maroon, Navy, Orange, Forest Green, Pink, Process Blue, Purple, Red, Reflex Blue, Teal, White, Yellow, Cream, Metallic Gold, Metallic Silver, Metallic Blue, Metallic Copper, Metallic Green, Metallic Magenta.

Note: Black velour sleeve included.

BIC® Pencil Solid

Item Number	Discription	Price Per Piece	
		500+	
BPS	Wooden Pencil Solid	0.34	

(R)

Barrel Colors: Red, Blue, Neon Green, Yellow, Black, Orange, Navy, Silver, Purple, White, Pink.

Specifications: Pencil has a gold ferrule, white eraser & #2 Graphite lead.

Barrel Imprint Area: 4" x ¾"

Additional Ink Color: Add \$.15(R) per piece for second imprint color.

Imprint Colors: White, Black, Red, Yellow, Orange, Pink, Navy, Reflex Blue, Process Blue, Purple, Burgundy, Maroon, Green, Teal, Forest Green, Brown, Charcoal, Cream, Metallic Blue, Metallic Green, Metallic Gold, Metallic Magenta, Metallic Copper, Metallic Silver.

BIC® Media Clic™ & Media Clic™ Grip

Item Number	Discription	Price Per Piece	
		300	500+
MC	Media Clic™	0.78	0.76
MCG	Media Clic™ Grip	1.08	1.01

(R)

Ink Colors: Black or Blue ink. Medium Ballpoint.

Barrel/Trim Colors:

Media Clic: Black, Forest Green, Light Blue, Navy, Pink, Red, Silver, Yellow, White. (Choose 1 barrel & 1 trim color)

Media Clic Grip: Black, Forest Green, Light Blue, Navy, Pink, Red, Yellow.

Media Clic Grip White Barrel only.

Imprint Area: Barrel: 2½" x ¾", Clip: ⅝" x ⅜"

Imprint Colors: Black, Brown, Burgundy, Charcoal, Green, Maroon, Navy, Orange, Forest Green, Pink, Process Blue, Purple, Red, Reflex Blue, Teal, White, Yellow, Cream, Metallic Gold, Metallic Silver, Metallic Blue, Metallic Copper, Metallic Green, Metallic Magenta.

Note: Price includes a 1-color imprint on barrel. Second & third color add \$.15(R) per piece.

BIC® Mechanical Pencils

Item Number	Discription	Price Per Piece	
		300	500+
PMRCG	Matic Grip®	1.42	1.38
PMRMC	Media Clic™	1.23	1.15

(R)

PMRCG **Lead/Erasers:** .7mm Lead, White Erasers.
Barrel Colors: White.
Trim/Grip Colors: Forest Green, Blue, Black or Red.
Clip Imprint Area: 1" x 1/8", Add \$.15(R) per piece for clip imprint.
Barrel Imprint Area: 1 1/2" x 1/2"
 Add \$.15(R) per piece for second imprint color.
 Price includes 3 - .7mm #2 graphite leads.

PMRMC **Lead/Erasers:** .7mm Lead, White Erasers.
Barrel Colors: Black, Navy or White.
Clip Imprint Area: 1 5/16" x 5/32", Add \$.15(R) per piece for clip imprint.
Barrel Imprint Area: 2 1/8" x 3/4"
 Add \$.15(R) per piece for second imprint color.
 Price includes 1 - .7mm #2 graphite lead.

Imprint Colors: Black, Brown, Burgundy, Charcoal, Green, Maroon, Navy, Orange, Forest Green, Pink, Process Blue, Purple, Red, Reflex Blue, Teal, White, Yellow, Cream, Metallic Gold, Metallic Silver, Metallic Blue, Metallic Copper, Metallic Green, Metallic Magenta.

BIC® Round Stic® Pens

Item Number	Discription	Price Per Piece	
		300	500+
RS	Round Stic®	0.58	

(R)

Ink Colors: Blue or Black - Fine Point, Blue, Black, Red or Purple - Medium Point.
Barrel/Trim Colors: Clear, Purple, Teal, Red, Black, Silver, Burgundy, Navy, Blue, Cream, Forest Green, Yellow, White, Pink, Orange, Green, Metallic Dark Blue, Metallic Green, Metallic Orange, Metallic Red.
 Choose 1 barrel & 1 trim color.

Imprint Colors: Black, Brown, Burgundy, Charcoal, Green, Maroon, Navy, Orange, Forest Green, Pink, Process Blue, Purple, Red, Reflex Blue, Teal, White, Yellow, Cream, Metallic Gold, Metallic Silver, Metallic Blue, Metallic Copper, Metallic Green, Metallic Magenta.

Barrel Imprint Area: 2 1/2" x 3/4"
 Price includes a 1-color imprint on barrel. Second color add \$.15(R) per piece.

BIC® Tri-Stic® & Tri-Stic® Clear Pens

Item Number	Discription	Price Per Piece	
		300	500+
TS	Tri-Stic®	1.00	0.95
TSCL	Tri-Stic® Clear	1.18	1.15

(R)

Ink Colors: TS: Black or Blue - Fine Point.
 TSCL: Black, Blue or Red - Medium Point.

TS Barrel/Trim Colors: Navy, Black, Forest Green, Blue, Yellow, Red, Teal, Cream, Purple, White, Green, Orange, Burgundy, Pink.

TSCL Clear Barrel Colors: Pink, Blue, Orange, Green, Purple, Clear, Black, Royal Blue, Red. **Trim Colors:** Transparent White Ice Only.

Imprint Colors: Black, Brown, Burgundy, Charcoal, Green, Maroon, Navy, Orange, Forest Green, Pink, Process Blue, Purple, Red, Reflex Blue, Teal, White, Yellow, Cream, Metallic Gold, Metallic Silver, Metallic Blue, Metallic Copper, Metallic Green, Metallic Magenta.

Imprint Area: 3" x 1/2" per panel
 Copy and imprint color may be different on each side at no additional cost.
Clip Imprint Area: 1 1/8" x 5/32" Add \$.15(R) per piece for clip imprint.

NOTE:



! Allow 3 extra days for proof.



BIC® Matic Grip®



BIC® Media Clic™



BIC® Round Stic®

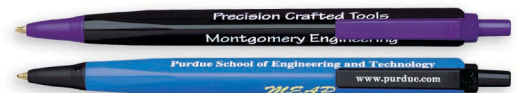

BIC® Tri-Stic®



BIC® Tri-Stic® Clear

Self Inking Stamps



A

NOT FOR PUBLICATION

Impression Area: 1½" x ⅝" (41mm x 16mm)



B

Mara Beth Stevens
1234 West End Drive
Chicago, IL 60611
312-555-1212

Impression Area: 2⅝" x ¾" (61mm x 20mm)



C

PAY TO THE ORDER OF
1ST LOCAL BANK AND TRUST
E. GRAND STREET BRANCH
FOR DEPOSIT ONLY
CLASSIC EDITION, INC.
ACCT. #123-45-678

Impression Area: 2½" x 1" (65mm x 25mm)



D

**HANDLE WITH CARE!
DO NOT X-RAY
COMPUTER DISCS**

Impression Area: 3" x 1½" (77mm x 39mm)



E

Received
Jan 19, 2016
Simply Sara's Clothing

Impression Area: 1½" x 1" (41mm x 24mm)

A Ideal 4911 Self Inking Stamps

Cat No.	Item	Size	Ink	Price
320009	Ideal 4911	1½" x ⅝"	Black	35.32
320013	Ideal 4911	1½" x ⅝"	Red	35.31

Maximum 3 lines of copy. (R)
Free bottle of ink included.

B Ideal 4913 Self Inking Stamps

Cat No.	Item	Size	Ink	Price
320010	Ideal 4913	2⅝" x ¾"	Black	37.59
320014	Ideal 4913	2⅝" x ¾"	Red	37.59

Maximum 4 lines of copy. (R)
Free bottle of ink included.

C Ideal 4914 Self Inking Stamps

Cat No.	Item	Size	Ink	Price
320011	Ideal 4914	2½" x 1"	Black	39.53
320015	Ideal 4914	2½" x 1"	Red	39.53

Maximum 7 lines of copy. (R)
Free bottle of ink included.

D Ideal 4926 Self Inking Stamps

Cat No.	Item	Size	Ink	Price
320012	Ideal 4926	3" x 1½"	Black	41.70
320016	Ideal 4926	3" x 1½"	Red	41.70

Maximum 9 lines of copy. (R)
Free bottle of ink included.

E Self Inking Date Stamps

Cat No.	Item	Price
320017	Date Stamp Only	35.96
320018	Date Stamp "Paid"	48.94
320019	Date Stamp "Received"	48.94
320020	Date Stamp "Faxed"	48.94

Black ink only. (R)

NOTE:



! Impressions are customizable with your info.

Forms That Work For Your Business.

Use these three easy steps to place your order:

- Step 1** - Choose the sales book size
- Step 2** - Determine parts needed
- Step 3** - Send us your camera-ready art

To personalize your sales book, add a custom or stock logo. Choose up to two colors to complete your book.

Back printing and part-to-part art changes are not available.

All original – each part is individually printed.

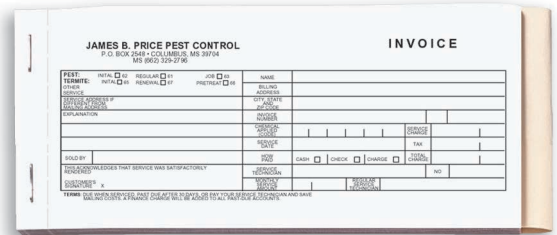
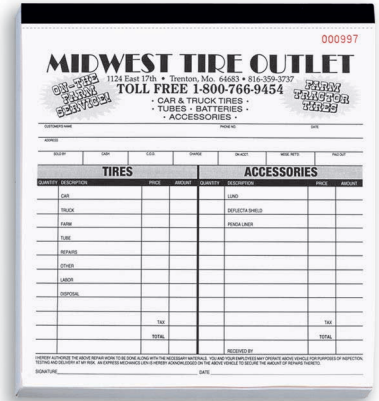
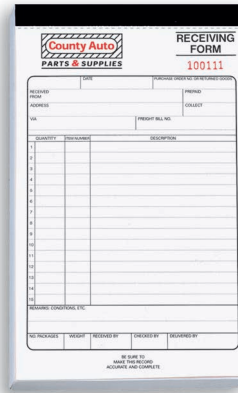

2-Part Carbonless - Stitched - 50 Sets Per Book

Cat. No.	Size	Last Pt. Perfed	Book Constr.	Pts.	Wt. 10 Bks	Carbonless Lot Prices				
						10 Bks	20 Bks	25 Bks	50 Bks	100 Bks
DFCSB-828-2	3 3/8" x 8 1/2"	Yes	Economy	2	4#	123.85	182.41	218.05	412.70	773.91
DFMB-034-2	5 1/2" x 8 1/2"	No	Manifold	2	5#	155.03	271.62	318.29	584.66	1,059.90
DFCSB-827-2	5 1/2" x 8 1/2"	Yes	Economy	2	5#	151.54	268.65	314.55	577.23	1,044.84
DFMB-063-2	8 1/2" x 7"	No	Manifold	2	7#	169.35	276.18	316.92	581.80	1,135.11
DFMB-037-2	8 1/2" x 8 1/2"	No	Manifold	2	8#	175.94	276.71	320.84	611.37	1,169.05
DFMB-036-2	8 1/2" x 11"	No	Manifold	2	9#	179.75	285.51	323.92	619.66	1,182.31
DFMB-020-2	8 1/2" x 14"	No	Manifold	2	10#	205.42	326.25	379.92	705.48	1,371.35

(R)

3-Part Carbonless - Stitched - 50 Sets Per Book

Cat. No.	Size	Last Pt. Perfed	Book Constr.	Pts.	Wt. 10 Bks	Carbonless Lot Prices				
						10 Bks	20 Bks	25 Bks	50 Bks	100 Bks
DFCSB-828-3	3 3/8" x 8 1/2"	Yes	Economy	3	6#	135.94	213.17	236.51	455.56	859.83
DFMB-034-3	5 1/2" x 8 1/2"	No	Manifold	3	8#	167.02	295.38	340.36	635.26	1,173.72
DFCSB-827-3	5 1/2" x 8 1/2"	Yes	Economy	3	8#	161.82	289.44	335.16	626.14	1,143.39
DFMB-063-3	8 1/2" x 7"	No	Manifold	3	10#	208.93	350.12	413.87	761.28	1,484.86
DFMB-037-3	8 1/2" x 8 1/2"	No	Manifold	3	12#	215.19	360.41	418.23	784.20	1,530.15
DFMB-036-3	8 1/2" x 11"	No	Manifold	3	13#	221.45	370.80	423.31	808.70	1,560.71
DFMB-020-3	8 1/2" x 14"	No	Manifold	3	15#	254.11	424.59	496.51	924.86	1,796.94

(R)

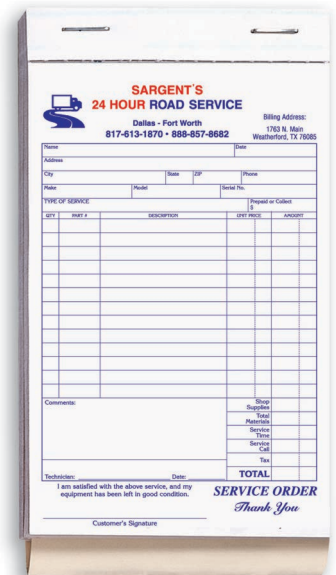

Special Feature Prices

Cat.No.	Quantity Lot Prices					
	5Bks	10Bks	20Bks	25Bks	50Bks	100Bks
	Numbering on Imprinted Forms/Books					
310025	13.43	13.43	18.52	36.46	53.93	89.89
	2-Hole Punch					
310050	24.42	24.42	24.42	28.93	33.32	38.89
	3-Hole Punch					
310056	38.54	38.54	38.54	43.17	47.91	56.94
	Heavy/Full Custom Composition					
310020	159.71 all quantities					
	Medium Composition Changes/Deletions					
310015	64.58 all quantities					
	Light Composition					
310014	24.65 all quantities					
	Fax Proof					
310007	15.63 per proof					

(R)

NOTE:

Book Construction

- Manifold
 - Front Flap
 - White Stock
 - Wrap-around Flap
 - Stitched & Taped (Black)
- Economy
 - No Front Flap
 - Manila Stock
 - Wrap-around Flap
 - Stitched, No Tape

Maximum Imprint Area

Form Size	Imprint Size
3 3/8" x 8 1/2"	3 1/8" x 8"
5 1/2" x 8 1/2"	5" x 8"
8 1/2" x 7"	8" x 6 1/2"
8 1/2" x 8 1/2"	8" x 8"
8 1/2" x 11"	8" x 10 1/2"
8 1/2" x 14"	8" x 13 1/2"



! Ready-To-Go Formats, see pages 130-131.

! Envelopes available, see page 100.

Custom Multiform Books

Whether stitched or wire bound, a multiform book adds convenience and reduces the number of lost forms. You can also add a custom cover for a professional look. Use one of our convenient Ready-to-Go formats or submit your custom art to make your book exactly what you need.

Design The Perfect Cover.

Once you have decided what you need in a book and how you want it bound, you can design the cover.

Covers are printed in Black ink. If you want your cover printed in another color, we can do that for you at an additional charge. 4-color process is available for an additional charge of \$30.60(R) for 500 [sheets] and \$61.20(R) for 1,000 [sheets].

Custom Book Covers are only available on stitched, wire bound and manifold books. No close registration and printing is one side only.

Custom Book Covers

1-100 Bks	101-200 Bks	201-300 Bks	301-400 Bks	401-500 Bks
125.97	135.63	145.38	154.93	165.23

(R)



Ordering Is Easy!

Choose:

- Number of forms per page: 2 to 8
- Type of book binding: Wire, Stitched, Economy
- Starting number
- Ink color
- Format: Ready-To-Go or Custom Art
- Optional special features
- Optional cover

Binding

Stitched

- Side-stitched for durability
- Heavy duty wire staples
- Wrap around flap
- Attractive matte black spine tape
- White stock front cover
- Economical

Wire

- Book lays flat when opened
- Plastic-coated heavy gauge wire
- Won't "spring" like spiral binding
- Includes wrap-around cover with flyleaf
- White stock front cover
- Top of the line

Economy

- Same as Wire, but with insert sheet instead of wrap-around cover.

Ink Choices for forms and covers

The standard is black ink but you can choose more than one color or a color other than black.

Blue PMS 293	PMS Black	Red PMS 185	PMS Reflex Blue	Hunter PMS 336	Maroon PMS 202	Orange PMS 165
Navy PMS 294	Blue PMS 300	Green PMS 347	Brown PMS 463	Burgundy PMS 1955	Gray PMS 430	PMS Yellow

Color Other Than Black	\$31.24
2-Color Combo	\$64.45
Proof	\$15.66
Colors shown are approximate. (R)	
No bleeds.	

Special Feature Prices

Cat.No.	Quantity Lot Prices					
	5Bks	10Bks	20Bks	25Bks	50Bks	100Bks
Numbering on Imprinted Forms/Books						
310025	13.43	13.43	18.52	36.46	53.93	89.89
2-Hole Punch						
310050	24.42	24.42	24.42	28.93	33.32	38.89
3-Hole Punch						
310056	38.54	38.54	38.54	43.17	47.91	56.94
Heavy/Full Custom Composition						
310020	159.71 all quantities					
Medium Composition Changes/Deletions						
310015	64.58 all quantities					
Light Composition						
310014	24.65 all quantities					
Fax Proof						
310007	15.66 per proof					

(R)

Two-On-A-Page Books

Shown in Ready-To-Go Formats

PO-12 - Ready-To-Go Format

Purchase Order, 8½" x 11" overall
Form size 8½" x 5½"
Imprint area ¾" x 5"

PO-22 - Ready-To-Go Format

Purchase Order, 8½" x 11" overall
Form size 8½" x 5½"
Imprint area ¾" x 5"

Sizes

Overall Size	8½" x 11"
Form Size	5½" x 8½"
Maximum Print Area	5" x 8"

2-Part Carbonless - 100 Receipts/50 Sheet Sets

Cat. No.	DFCWB-	Bind	Last Pt. Perfed	Pts.	Wt. 10 Bks	Carbonless Lot Prices				
						10 Bks	20 Bks	25 Bks	50 Bks	100 Bks
055-2		Stitched	No	2	9#	154.19	281.91	309.60	591.24	1,116.23
057-2		Wire	No	2	9#	187.39	346.09	392.55	742.40	1,447.20

(R)

3-Part Carbonless - 100 Receipts/50 Sheet Sets

Cat. No.	DFCWB-	Bind	Last Pt. Perfed	Pts.	Wt. 10 Bks	Carbonless Lot Prices				
						10 Bks	20 Bks	25 Bks	50 Bks	100 Bks
055-3		Stitched	No	3	19#	250.62	452.38	508.28	960.08	1,863.14
057-3		Wire	No	3	19#	283.92	518.25	591.02	1,125.46	2,194.32

(R)

NOTE:



Colors correspond to sequence and number of parts selected in your order unless otherwise specified.



! Back printing and part-to-part changes are not available. Last part is not perforated.

! All formats available with stitched or wire binding.

Custom Multiform Books

Three-On-A-Page Books

Shown in Ready-To-Go Formats

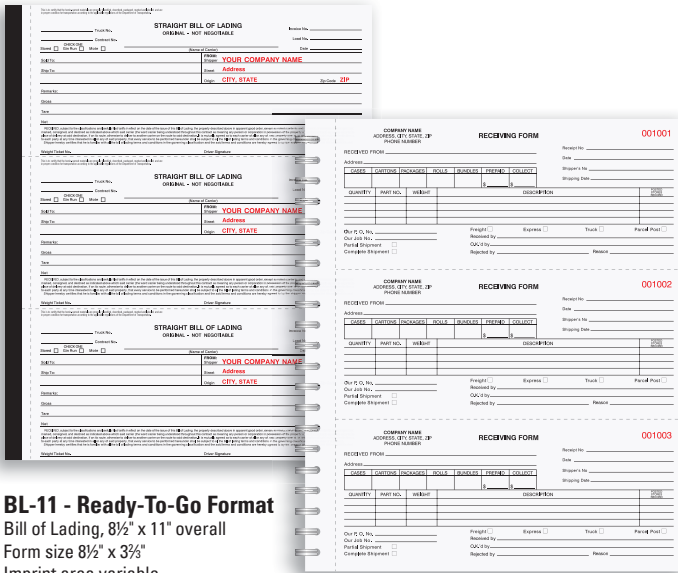

BL-11 - Ready-To-Go Format

Bill of Lading, 8½" x 11" overall
Form size 8½" x 3½"
Imprint area variable

RF-13 - Ready-To-Go Format

Receiving Form, 8½" x 11" overall
Form size 8½" x 3½"
Imprint area ½" x 2¾"

Sizes

Overall Size	8½" x 11"
Form Size	8½" x 3½"
Maximum Print Area	8" x 3"

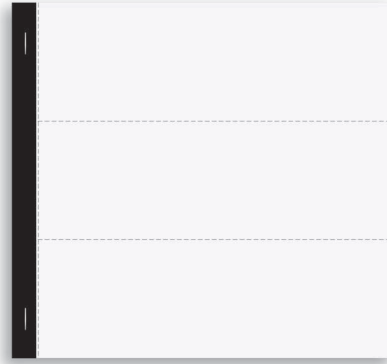

DFCWB-027

Stitched Book*
Overall: 9¼" x 8¼"
Form size 8½" x 2¾"
Imprint area 2½" x 8"

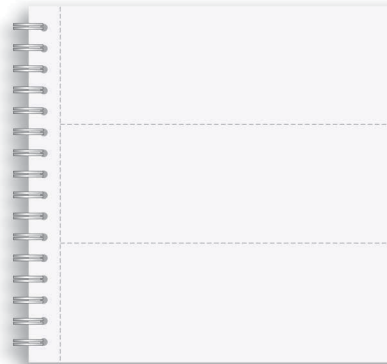

DFCWB-028

Wire Bound Book*
Overall: 9¼" x 8¼"
Form size 8½" x 2¾"
Imprint area 2½" x 8"

*Special sizes.

2-Part Carbonless

Cat. No.	# Sheet	# Receipts	Bind	Last Pt.	Perfed	Pts.	Carbonless Lot Prices				
							5 Bks	5 Bks	10 Bks	25 Bks	50 Bks
066-2	50	150	Stitched	No	2	8#	103.69	154.19	309.59	591.24	1,116.23
068-2	50	150	Wire	No	2	8#	120.14	187.39	392.55	742.40	1,447.20
060-2	63	189	Stitched	No	2	8#	135.09	202.98	411.75	769.66	1,492.39
062-2	63	189	Wire	No	2	8#	151.22	235.87	494.70	935.47	1,823.67
826-2	75	225	Economy	No	2	10#	177.42	276.92	576.17	1,100.53	--
886-2	75	225	Economy	Yes	2	10#	177.42	276.92	576.17	1,100.53	--
027-2	50*	150	Stitched	No	2	7#	98.39	146.55	294.11	561.75	1,060.43
028-2	50*	150	Wire	No	2	7#	114.09	178.06	372.92	705.27	1,374.74

*Note: Different form and overall size.

(R)

3-Part Carbonless

Cat. No.	# Sheet	# Receipts	Bind	Last Pt.	Perfed	Pts.	Carbonless Lot Prices				
							5 Bks	5 Bks	10 Bks	25 Bks	50 Bks
066-3	50	150	Stitched	No	3	9#	163.95	250.83	508.28	960.08	1,863.14
068-3	50	150	Wire	No	3	9#	180.60	283.71	591.02	1,125.46	2,194.32
826-3	50	150	Economy	No	3	10#	178.16	278.73	580.52	1,109.12	--
886-3	50	150	Economy	Yes	3	10#	178.16	278.73	580.52	1,109.12	--
060-3	42	126	Stitched	No	3	9#	135.31	205.21	413.87	780.38	1,511.27
062-3	42	126	Wire	No	3	9#	151.75	238.20	496.61	945.86	1,842.34
027-3	50*	150	Stitched	No	3	8#	155.78	238.20	482.93	912.02	1,770.00
028-3	50*	150	Wire	No	3	8#	171.69	269.50	561.53	1,069.13	2,084.53

*Note: Different form and overall size.

(R)

4-Part Carbonless

Cat. No.	# Sheet	# Receipts	Bind	Last Pt.	Perfed	Pts.	Carbonless Lot Prices				
							5 Bks	5 Bks	10 Bks	25 Bks	50 Bks
826-4	50	150	Economy	No	4	14#		224.41	352.24	732.96	1,400.20

(R)

NOTE:



Colors correspond to sequence and number of parts selected in your order unless otherwise specified.



Four-On-A-Page Books

RB-14 - Ready-To-Go Format
 Receipt Book, 8½" x 11" overall
 Form size 8½" x 2¾"
 Imprint area ½" x 4"

PO-14 - Ready-To-Go Format
 Purchase Order, 8½" x 11" overall
 Form size 8½" x 2¾"
 Imprint area ½" x 4"

PO-24 - Ready-To-Go Format
 Purchase Order, 8½" x 11" overall
 Form size 8½" x 2¾"
 Imprint area ½" x 4"

Sizes

Overall Size	8½" x 11"
Form Size	8½" x 2¾"
Maximum Print Area	8" x 2½"

2-Part Carbonless

Cat. No.	# Sheet	# Receipts	Last Pt.	Pts.	Wt.	Carbonless Lot Prices					
						5 Bks	5 Bks	10 Bks	25 Bks	50 Bks	100 Bks
083-2	50	200	Stitched	No	2	8#	103.69	154.19	309.59	591.24	1,116.23
088-2	50	200	Wire	No	2	8#	120.14	187.39	392.55	742.40	1,447.20
070-2	63	252	Stitched	No	2	8#	135.09	202.98	411.75	769.66	1,492.39
072-2	63	252	Wire	No	2	8#	151.22	235.87	494.70	935.47	1,823.67
824-2	75	300	Economy	No	2	10#	177.42	276.92	576.17	1,100.53	--
884-2	75	300	Economy	Yes	2	10#	177.42	276.92	576.17	1,100.53	--

(R)

3-Part Carbonless

Cat. No.	# Sheet	# Receipts	Last Pt.	Pts.	Wt.	Carbonless Lot Prices					
						5 Bks	5 Bks	10 Bks	25 Bks	50 Bks	100 Bks
083-3	50	200	Stitched	No	3	9#	163.95	250.83	508.28	960.08	1,863.14
088-3	50	200	Wire	No	3	9#	180.60	283.71	591.02	1,125.46	2,194.32
824-3	50	200	Economy	No	3	10#	178.16	278.73	580.52	1,109.12	--
884-3	50	200	Economy	Yes	3	10#	178.16	278.73	580.52	1,109.12	--
070-3	42	168	Stitched	No	3	9#	135.31	205.21	413.87	780.38	1,511.27
072-3	42	168	Wire	No	3	9#	151.75	238.20	496.61	945.86	1,842.34

(R)

4-Part Carbonless

Cat. No.	# Sheet	# Receipts	Last Pt.	Pts.	Wt.	Carbonless Lot Prices					
						5 Bks	5 Bks	10 Bks	25 Bks	50 Bks	
824-4	50	200	Economy	No	4	14#		235.76	369.74	769.56	1,470.32

(R)

NOTE:

- ❗ See page 124 for special feature prices and ink colors.
- ❗ All formats available with stitched or wire binding.
- ❗ Design perfect cover, see page 124.

Six-On-A-Page, Eight-On-A-Page

Ordering Is Easy!

Choose:

- Number of forms per page
- Type of book binding
- Starting number
- Ink color
- Ready-To-Go style or submit your custom art
- Provide imprint information

Sizes Six-On-A-Page

Overall Size	11" x 9½"
Form Size	4¾" x 3⅜"
Maximum Print Area	4½" x 3"

Sizes Eight-On-A-Page

Overall Size	11" x 9½"
Form Size	4¾" x 2¾"
Maximum Print Area	4½" x 2½"



PO-16 - Ready-To-Go Format
Purchase Order, 11" x 9½" overall
Form size 4¾" x 3⅜"
Imprint area 1" x 2"

PO-18 - Ready-To-Go Format
Purchase Order, 11" x 9½" overall
Form size 4¾" x 2¾"
Imprint area ½" x 2¼"

2-Part Carbonless - Six-On-A-Page

Cat. No.	# Sheet	# Receipts	Last Pt.	Wt.	Carbonless Lot Prices						
					5 Bks	10 Bks	25 Bks	100 Bks			
090-2	83	498	Stitched	No	2	9#	182.93	277.66	568.85	1,066.90	2,071.16
092-2	83	498	Wire	No	2	9#	199.48	310.87	651.70	1,232.49	2,402.34

(R)

3-Part Carbonless - Six-On-A-Page

Cat. No.	# Sheet	# Receipts	Last Pt.	Wt.	Carbonless Lot Prices						
					5 Bks	10 Bks	25 Bks	100 Bks			
090-3	56	336	Stitched	No	3	10#	185.80	284.67	579.36	1,095.33	2,125.37
092-3	56	336	Wire	No	3	10#	202.35	317.97	662.20	1,260.81	2,456.97

(R)

2-Part Carbonless - Eight-On-A-Page

Cat. No.	# Sheet	# Receipts	Last Pt.	Wt.	Carbonless Lot Prices						
					5 Bks	10 Bks	25 Bks	100 Bks			
095-2	83	664	Stitched	No	2	9#	182.93	277.66	568.85	1,066.90	2,071.16
097-2	83	664	Wire	No	2	9#	199.48	310.87	651.70	1,232.49	2,402.34

(R)

3-Part Carbonless - Eight-On-A-Page

Cat. No.	# Sheet	# Receipts	Last Pt.	Wt.	Carbonless Lot Prices						
					5 Bks	10 Bks	25 Bks	100 Bks			
095-3	56	448	Stitched	No	3	10#	185.80	284.67	579.36	1,095.33	2,125.37
097-3	56	448	Wire	No	3	10#	202.35	317.97	662.20	1,260.81	2,456.97

(R)

NOTE:



Colors correspond to sequence and number of parts selected in your order unless otherwise specified.



NOTE:

- ! See page 124 for special feature prices, ink colors and book binding.
- ! All formats available with stitched or wire binding.
- ! Back printing and part-to-part changes are not available.

Predesigned Layout Options

Ordering Is Easy!

Choose:

- Number of forms per page
- Type of book binding
- Starting number
- Ink color
- Ready-To-Go style (or submit your custom art)
- Provide imprint information

PO-13
Purchase Order
Form size 8½" x 3¾"
Imprint area ½" x 4"

PO-23
Purchase Order
Form size 8½" x 3¾"
Imprint area ½" x 4"

RB-13
Receipt Book
Form size 8½" x 3¾"
Imprint area ¾" x 4"

RB-23
Receipt Book
Form size 8½" x 3¾"
Imprint area 1" x 5"

RB-33
Receipt Book
Form size 8½" x 3¾"
Imprint area ¼" x 2½"

NOTE:

- All formats available with stitched or wire binding.
- See page 126 for pricing.

Predesigned Layout Options

YOUR COMPANY NAME
Address
CITY, STATE, ZIP CODE
Phone Number
Advertising Line

CHANGE ORDER
001001

TO	PHONE	DATE
JOB NUMBER/AGENT		
JOB LOCATION		
ORDER CONTRACT NUMBER	ORDER CONTRACT DATE	ORDER EXTENSION
JOB PHONE		

WE HEREBY agree to make the changes specified above at this total price:

PREVIOUS CONTRACT AMOUNT	\$
REBID CONTRACT TOTAL	\$

NOTE: This Change Order becomes part of and in conformance with the existing contract.

WE AGREE hereby to make the change(s) specified above at this total price:

DATE: _____

AUTHORIZED SIGNATURE CONTRACTOR: _____

SALES/ADVERTISING: _____

AGENCY ADDRESS: _____

AGENCY PHONE: _____

ACCEPTED - The above prices and specifications of the Change Order are satisfactory and are hereby accepted. All work is to be performed under the same terms and conditions as specified in the original contract unless otherwise specified.

CO-21
Change Order
Form size 8½" x 14"
Imprint area 1" x 4"

CO-11
Change Order
Form size 8½" x 11"
Imprint area 1" x 4"

YOUR COMPANY NAME
Address
CITY, STATE, ZIP CODE
Phone Number
Advertising Line

INVOICE
001001

DATE						
S O L D T O	S H I P T O					
OUR ORDER NO.	DATE SHIPPED	SHIPPED TO	TERMS	SALESMAN	QUOTA	OUR ORDER NO.
QUANTITY	DESCRIPTION	UNIT PRICE	AMOUNT			

YOUR COMPANY NAME
Address
CITY, STATE, ZIP CODE
Phone Number
Advertising Line

INVOICE
001001

DATE						
S O L D T O	S H I P T O					
OUR ORDER NO.	DATE SHIPPED	SHIPPED TO	TERMS	SALESMAN	QUOTA	OUR ORDER NO.
QUANTITY	DESCRIPTION	UNIT PRICE	AMOUNT			

Thank You

IN-31
Invoice
Form size 8½" x 11"
Imprint area 1" x 4"

IN-21
Invoice
Form size 8½" x 8½"
Imprint area 1" x 4"

IN-11
Invoice
Form size 8½" x 7"
Imprint area 1" x 4"

NOTE:

Ordering Is Easy!

Choose:

- Number of forms per page: 2 to 8
- Type of book binding: Wire, Stitched, Economy
- Starting number
- Ink color
- Format: Ready-To-Go or Custom Art
- Optional special features
- Optional cover
- See page 123, 132 & 133 for pricing

Binding

Stitched

- Side-stitched for durability
- Heavy duty wire staples
- Wrap around flap
- Attractive matte black spine tape
- White stock front cover
- Economical

Wire

- Book lays flat when opened
- Plastic-coated heavy gauge wire
- Won't "spring" like spiral binding
- Includes wrap-around cover with flyleaf
- White stock front cover
- Top of the line

Economy

- Same as Wire, but with insert sheet instead of wrap-around cover.

Ink Choices for forms and covers

The standard is black ink but you can choose more than one color or a color other than black.

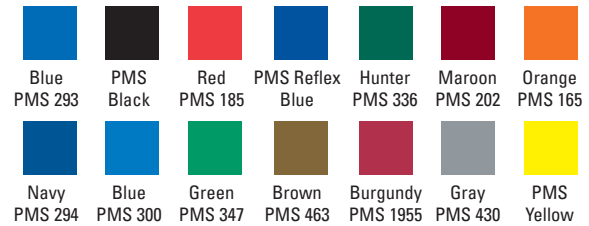

Color Other Than Black	\$31.24
Two Color Combo	\$64.45
Proof	\$15.66

Colors shown are approximate. (R)
No bleeds.



Colors correspond to sequence and number of parts selected in your order unless otherwise specified.

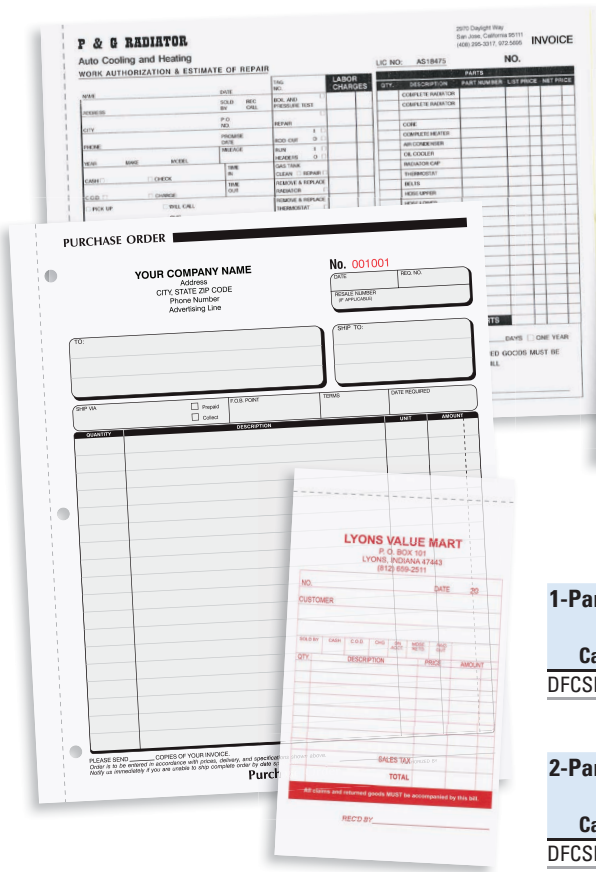

Design The Form You Need

Can't find a stock form that works for your business?

Design your own with the columns, lines and spaces you need. Add your company logo or use one of our stock logos (see pages 134-136) and choose up to two PMS colors for your form for an additional charge. See page 130.

Back printing and part-to-part changes are not available. Available without stub. Please request this option when placing your order. All original - each part is individually printed.

Custom Register Forms Available. Call for Pricing.

NOTE:

Maximum Imprint Area

Form Size	Imprint Size
4 1/4" x 7"	3 3/4" x 6 1/2"
5 1/2" x 8 1/2"	5" x 8"
8 1/2" x 7"	8" x 6 1/2"
8 1/2" x 8 1/2"	8" x 8"
8 1/2" x 11"	8" x 10 1/2"
8 1/2" x 14"	8" x 13 1/2"
11" x 8 1/2"	10 1/2" x 8"

See page 124 for additional charges.



Colors correspond to sequence and number of parts selected in your order unless otherwise specified.



1-Part Laser

Cat. No.	Size	Pts.	Wt. per 1000	Carbonless Lot Prices				
				250	500	1000	2000	5000
DFCSF-829-1	8 1/2" x 11"	1	11#	97.22	129.68	203.94	350.75	851.03

(R)

2-Part Carbonless - Snap-A-Part

Cat. No.	Size	Last Pt. Perf	Last Pt. Tag	Pts.	Wt. per 1000	Carbonless Lot Prices				
						250	500	1000	2000	5000
DFCSF-823-2	4 1/4" x 7"	Yes	No	2	8#	88.63	115.47	178.27	303.02	651.81
DFPC-089-2	5 1/2" x 8 1/2"	Yes	No	2	10#	111.54	148.67	236.51	432.44	1,049.82
DFPC-099-2	8 1/2" x 7"	Yes	No	2	13#	121.73	162.36	255.71	439.75	1,066.79
DFPC-023-2	8 1/2" x 8 1/2"	Yes	No	2	14#	125.55	167.34	263.34	453.23	1,098.72
DFPC-069-2*	8 1/2" x 11"	Yes	No	2	16#	129.68	172.65	272.04	468.08	1,134.37
DFCSF-889-2	8 1/2" x 11"	Yes	Yes	2	25#	142.31	190.04	299.30	514.65	1,248.40
DFPC-079-2	8 1/2" x 14"	Yes	No	2	19#	148.88	198.63	312.67	538.09	1,305.37
DFPC-029-2	11" x 8 1/2"	Yes	No	2	16#	155.67	207.23	326.46	561.64	1,361.17

*Also available as DFCSF-829-2 item number.

(R)

3-Part Carbonless - Snap-A-Part

Cat. No.	Size	Last Pt. Perf	Last Pt. Tag	Pts.	Wt. per 1000	Carbonless Lot Prices				
						250	500	1000	2000	5000
DFCSF-823-3	4 1/4" x 7"	Yes	No	3	12#	98.18	135.41	217.62	381.83	868.42
DFPC-089-3	5 1/2" x 8 1/2"	Yes	No	3	16#	118.33	157.90	285.51	518.25	1,163.75
DFPC-099-3	8 1/2" x 7"	Yes	No	3	19#	151.75	202.35	336.22	583.17	1,414.42
DFPC-023-3	8 1/2" x 8 1/2"	Yes	No	3	22#	156.31	208.39	346.09	600.78	1,456.11
DFPC-069-3*	8 1/2" x 11"	Yes	No	3	25#	161.51	215.18	357.44	620.41	1,504.48
DFCSF-889-3	8 1/2" x 11"	Yes	Yes	3	35#	177.63	236.51	393.29	636.11	1,542.35
DFPC-079-3	8 1/2" x 14"	Yes	No	3	29#	185.48	247.43	411.01	713.33	1,730.11
DFPC-029-3	11" x 8 1/2"	Yes	No	3	25#	193.76	257.93	428.93	744.52	1,805.32

*Also available as DFCSF-829-3 item number.

(R)

4-Part Carbonless - Snap-A-Part

Cat. No.	Size	Last Pt. Perf	Last Pt. Tag	Pts.	Wt. per 1000	Carbonless Lot Prices				
						250	500	1000	2000	5000
DFPC-089-4	5 1/2" x 8 1/2"	Yes	No	4	22#	126.18	168.19	310.55	559.09	1,288.82
DFPC-099-4	8 1/2" x 7"	Yes	No	4	25#	180.28	240.32	412.60	760.12	1,843.72
DFPC-023-4	8 1/2" x 8 1/2"	Yes	No	4	30#	185.59	247.64	424.80	783.03	1,898.25
DFPC-069-4*	8 1/2" x 11"	Yes	No	4	32#	191.53	255.39	438.91	808.28	1,960.20
DFCSF-889-4	8 1/2" x 11"	Yes	Yes	4	43#	211.05	281.27	482.50	889.53	2,156.45
DFPC-079-4	8 1/2" x 14"	Yes	No	4	39#	220.49	293.89	504.89	929.74	2,263.91
DFPC-029-4	11" x 8 1/2"	Yes	No	4	32#	229.82	306.52	526.74	969.94	2,352.16

*Also available as DFCSF-829-4 item number.

(R)

Snap-A-Part - 2 Part

Cat. No.	DFCC-	Size	Pts.	Wt. per 1000	Carbonless Lot Prices				
					250	500	1000	2000	3000
830-2	4 1/4" x 7"	2	6#	83.11	103.80	151.85	247.75	339.62	
831-2	5 1/2" x 8 1/2"	2	9#	90.01	117.38	178.48	300.90	421.08	
832-2	8 1/2" x 7"	2	10#	96.27	127.56	197.68	336.54	482.72	
834-2	8 1/2" x 11"	2	16#	123.32	161.83	216.88	423.84	622.00	
835-2*	8 1/2" x 11"	2	25#	120.14	165.54	270.45	513.69	759.80	

*Last part is manila tag. (R)
No back printing available.

Snap-A-Part - 3 Part

Cat. No.	DFCC-	Size	Pts.	Wt. per 1000	Carbonless Lot Prices				
					250	500	1000	2000	3000
830-3	4 1/4" x 7"	3	9#	90.96	119.92	183.25	310.55	439.33	
831-3	5 1/2" x 8 1/2"	3	13#	101.78	140.50	225.15	389.68	560.90	
832-3	8 1/2" x 7"	3	16#	115.15	163.20	265.78	469.78	674.09	
833-3	8 1/2" x 8 1/2"	3	20#	129.36	182.19	295.49	520.16	747.49	
834-3	8 1/2" x 11"	3	25#	141.99	207.55	344.60	618.92	897.60	
835-3*	8 1/2" x 11"	3	35#	143.15	215.18	360.62	667.19	975.14	
836-3*	5 1/2" x 8 1/2"	3	21#	102.74	143.26	230.56	400.08	576.60	
837-3*	8 1/2" x 8 1/2"	3	26#	135.52	197.15	327.31	585.19	844.77	

*Last part is manila tag. (R)
No back printing available.

Snap-A-Part - 4 Part

Cat. No.	DFCC-	Size	Pts.	Wt. per 1000	Carbonless Lot Prices				
					250	500	1000	2000	3000
831-4	5 1/2" x 8 1/2"	4	20#	107.72	149.10	237.99	414.72	599.62	
832-4	8 1/2" x 7"	4	25#	132.44	196.51	328.79	581.58	859.62	
833-4	8 1/2" x 8 1/2"	4	26#	150.79	222.29	371.76	663.80	959.76	
834-4	8 1/2" x 11"	4	32#	156.20	239.48	411.43	758.84	1,104.56	
835-4*	8 1/2" x 11"	4	43#	174.55	263.45	448.98	822.49	1,195.04	
836-4*	5 1/2" x 8 1/2"	4	27#	114.30	165.75	275.33	489.93	712.17	

*Last part is manila tag. (R)
No back printing available.

Special Feature Prices

Cat. No.	Quantity Lot Prices				
	250	500	1000	2000	3000
Numbering on Imprinted Forms/Books					
310025	13.43	13.43	18.52	36.46	53.93
2-Hole Punch					
310050	24.42	24.42	24.42	28.93	33.32
3-Hole Punch					
310056	38.54	38.54	38.54	43.17	47.91
Heavy/Full Custom Composition					
310020	159.71 all quantities				
Medium Composition Changes/Deletions					
310015	64.58 all quantities				
Light Composition					
310014	24.65 all quantities				
Snaps Bound in Books of 50					
330021	11.65 per 1000 all quantities				
Fax Proof					
310007	15.63 per proof				

(R)

Full Body Crash Printed!

Choose from one of four standard ink colors, red, green, blue or black, for your imprint. These forms are full body crash imprinted so fine lines, screens and heavy solids do not reproduce well.

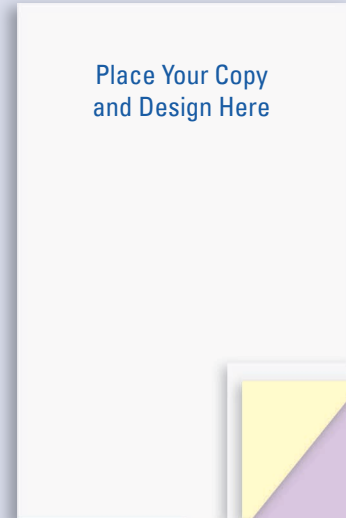

Place Your Copy and Design Here

NOTE:

Maximum Imprint Area

Form Size	Imprint Size
4 1/4" x 7"	3 3/4" x 6 1/4"
5 1/2" x 8 1/2"	5" x 7 3/4"
8 1/2" x 7"	8" x 6 1/4"
8 1/2" x 8 1/2"	8" x 7 3/4"
8 1/2" x 11"	8" x 10 1/4"



Includes your company's name, address and phone number in one of four colors! For blank forms, subtract 30% unless otherwise listed.



Colors correspond to sequence and number of parts selected in your order unless otherwise specified.



! Envelopes available, see page 100.

Stock Logos

										
Appliance AP-1	Appliance AP-2	Appliance AP-3	Appliance AP-4	Appliance AP-5	Appliance AP-6	Appliance AP-7	Appliance AP-8	Appliance AP-10	Auto Repair AU-1	Auto Sales AU-2
										
Auto Sales AU-3	Auto Sales AU-5	Auto Repair AU-6	Auto Repair AU-7	Auto Repair AU-8	Auto Repair AU-9	Auto Repair AU-10	Auto Repair AU-13	Auto Repair AU-16	Auto Repair AU-19	Auto Repair AU-20
										
Auto Repair AU-21	Auto Repair AU-22	Auto Repair AU-23	Beauty BE-1	Beauty BE-2	Beauty BE-3	Beauty BE-4	Beauty BE-5	Beauty BE-6	Building BU-2	Building BU-3
										
Building BU-5	Building BU-6	Building BU-7	Building BU-8	Building BU-11	Building BU-12	Building BU-13	Building BU-14	Building BU-15	Building BU-16	Building BU-17
										
Carpet CA-1	Carpet CA-2	Carpet CA-3	Carpet CA-4	Carpet CA-5	Cleaning CL-2	Cleaning CL-3	Cleaning CL-4	Cleaning CL-5	Cleaning CL-6	Cleaning CL-7
										
Cleaning CL-9	Cleaning CL-10	Cleaning CL-11	Cleaning CL-12	Cleaning CL-13	Clothing CS-1	Clothing CS-2	Clothing CS-3	Clothing CS-4	Clothing CS-5	Clothing CS-6
										
Construction CO-1	Construction CO-3	Construction CO-4	Construction CO-6	Construction CO-7	Construction CO-8	Construction CO-10	Drugs DR-1	Drugs DR-2	Drugs DR-3	Drugs DR-4
										
Drugs DR-6	Electrical EL-1	Electrical EL-2	Electrical EL-4	Electrical EL-5	Electrical EL-6	Exterminator EX-1	Exterminator EX-4	Exterminator EX-5	Exterminator EX-6	Exterminator EX-7
										
Exterminator EX-9	Farming FA-1	Farming FA-2	Farming FA-3	Farming FA-4	Farming FA-5	Farming FA-7	Farming FA-8	Farming FA-9	Farming FA-10	Farming FA-11



Flooring
FL-1



Flooring
FL-5



Flooring
FL-6



Flooring
FL-7



Flooring
FL-8



Flooring
FL-9



Food
FO-1



Food
FO-2



Food
FO-3



Food
FO-4



Food
FO-5



Food
FO-6



Food
FO-7



Food
FO-8



Food
FO-9



Food
FO-10



Food
FO-11



Food
FO-12



Food
FO-13



Food
FO-14



Food
FO-15



Food
FO-16



Food
FO-17



Food
FO-18



Food
FO-20



Food
FO-21



Food
FO-22



Food
FO-23



Floral/Gift
GI-1



Floral/Gift
GI-2



Floral/Gift
GI-4



Floral/Gift
GI-5



Floral/Gift
GI-6



Floral/Gift
GI-7



Floral/Gift
GI-8



Floral/Gift
GI-12



Floral/Gift
GI-13



Floral/Gift
GI-14



Floral/Gift
GI-15



Floral/Gift
GI-16



Floral/Gift
GI-17



Floral/Gift
GI-18



Floral/Gift
GI-21



Floral/Gift
GI-22



Floral/Gift
GI-23



Floral/Gift
GI-24



Floral/Gift
GI-25



Floral/Gift
GI-26



Floral/Gift
GI-27



Floral/Gift
GI-28



Floral/Gift
GI-29



Furniture
FU-3



Furniture
FU-4



Furniture
FU-5



Furniture
FU-6



Heat/Air
HE-3



Heat/Air
HE-4



Heat/Air
HE-5



Heat/Air
HE-6



Heat/Air
HE-7



Heat/Air
HE-8



Heat/Air
HE-9



Heat/Air
HE-10



Heat/Air
HE-11



Home Repair
HO-3



Home Repair
HO-4



Home Repair
HO-6



Home Repair
HO-7



Home Repair
HO-12



Home Repair
HO-13



Home Repair
HO-14



Home Repair
HO-15



Home Repair
HO-18



Hotel/Motel
HM-1



Hotel/Motel
HM-2



Hotel/Motel
HM-3



Hotel/Motel
HM-4



Insurance
IN-1



Insurance
IN-2



Insurance
IN-3



Insurance
IN-4



Insurance
IN-6



Jewelry
JE-2



Jewelry
JE-3



Jewelry
JE-5



Jewelry
JE-6



Jewelry
JE-7



Jewelry
JE-8



Jewelry
JE-9



Jewelry
JE-10



Jewelry
JE-12



Jewelry
JE-13



Landscaping
LA-1



Landscaping
LA-2



Landscaping
LA-4



Landscaping
LA-5



Landscaping
LA-6



Landscaping
LA-7



Landscaping
LA-8

Stock Logos



Landscaping
LA-9



Legal
LE-1



Legal
LE-2



Legal
LE-3



Legal
LE-4



Marinas
MA-1



Marinas
MA-2



Marinas
MA-3



Marinas
MA-4



Marinas
MA-6



Marinas
MA-7



Marinas
MA-8



Marinas
MA-9



Misc.
MI-1



Misc.
MI-2



Misc.
MI-3



Misc.
MI-4



Misc.
MI-5



Misc.
MI-6



Misc.
MI-7



Misc. Retail
MR-1



Misc. Retail
MR-2



Misc. Retail
MR-4



Misc. Retail
MR-5



Misc. Retail
MR-6



Misc. Retail
MR-7



Misc. Retail
MR-9



Misc. Retail
MR-10



Misc. Retail
MR-11



Misc. Retail
MR-12



Motorcycle
MO-1



Motorcycle
MO-2



Motorcycle
MO-3



Motorcycle
MO-5



Motorcycle
MO-6



Office Supp.
OF-1



Office Supp.
OF-4



Office Supp.
OF-6



Office Supp.
OF-7



Office Supp.
OF-8



Office Supp.
OF-10



Office Supp.
OF-11



Office Supp.
OF-12



Office Supp.
OF-13



Painters
PA-1



Painters
PA-2



Painters
PA-3



Painters
PA-4



Painters
PA-5



Painters
PA-7



Painters
PA-8



Painters
PA-9



Painters
PA-10



Painters
PA-11



Photography
PH-1



Photography
PH-2



Photography
PH-3



Photography
PH-4



Photography
PH-5



Photography
PH-6



Photography
PH-7



Plumbing
PL-1



Plumbing
PL-2



Plumbing
PL-3



Plumbing
PL-4



Plumbing
PL-6



Plumbing
PL-7



Real Estate
RE-3



Real Estate
RE-4



Towing
TO-2



Towing
TO-3



Towing
TO-8



Towing
TO-9



Travel
TV-1



Travel
TV-2



Travel
TV-4



Travel
TV-5



Travel
TV-7



Trucks
TR-1



Trucks
TR-2



Trucks
TR-3



Trucks
TR-6



Trucks
TR-8



Trucks
TR-9



Trucks
TR-11

Locate the Perfect Form!

Finding the form you need is easy. We have provided this alphabetical index to help you find what you are looking for.

Form	Page	Form	Page	Form	Page	Form	Page	Form	Page	Form	Page
#		491220.....	106	ARO-372-4.....	7	CDCC-374-5.....	41	DCCC-392-2.....	87	DFC-148-2.....	89
202.....	33	491230.....	106	ARO-373-4.....	10	CM-235-2.....	80	DCCC-392-3.....	87	DFC-174-1.....	91
204.....	33	491240.....	106	ARO-637-3.....	9	CM-235-3.....	80	DCCC-393-3.....	87	DFC-174-2.....	91
312.....	33	491250.....	160	ARO-637-4.....	9	CM-579-3.....	80	DCCC-394-2.....	87	DFC-175-1.....	91
412.....	30	491260.....	106	ARO-647-3.....	6	CMCC-574-4.....	79	DCCC-394-3.....	87	DFC-175-2.....	91
422.....	31	491270.....	106	ARO-647-4.....	6	CMCC-575-4.....	79	DCCC-470-2.....	87	DFC-176-1.....	91
434.....	31	491275.....	116	ARO-655-2.....	8	CMCC-576-3.....	80	DCCC-470-3.....	87	DFC-176-2.....	91
700.....	30	491276.....	116	ARO-655-3.....	8	CO-696-3.....	43	DCCC-472-2.....	87	DFC-182-1.....	91
814.....	30	491277.....	116	ARO-656-3.....	6	COCC-583-3.....	43	DCCC-472-3.....	87	DFC-182-2.....	91
0108.....	113	493000.....	105	ARO-657-3.....	8	COPA-185-2.....	37	DCCC-473-2.....	87	DFC-183-1.....	91
1209.....	108	493040.....	105	ARO-659-3.....	9	CPCC-795-3.....	23	DCCC-615-2.....	88	DFC-184-1.....	91
1226.....	108	493080.....	105	ARO-659-4.....	9	CPCC-796-3.....	23	DCCC-615-3.....	88	DFC-186-1.....	90
4246.....	30	493160.....	105	ARO-666-3.....	7	CRB-110-2.....	66	DCCC-622-2.....	88	DFC-186-2.....	90
4611.....	32	493200.....	105	ARO-671-4.....	10	CRB-110-3.....	66	DCCC-622-3.....	88	DFC-187-1.....	90
4622.....	32	493240.....	105	ARO-672-4.....	7	CRB-111-2.....	66	DCCC-623-2.....	88	DFC-187-2.....	90
4651.....	29	493400.....	105	ARO-682-3.....	9	CRB-111-3.....	66	DCCC-623-3.....	88	DFCC-830-2.....	133
4805.....	34	493440.....	105	ARO-682-4.....	9	CRB-114-2.....	66	DCCC-626-2.....	88	DFCC-830-3.....	133
4851.....	29	493480.....	105	AROCC-365-4.....	7	CRB-114-3.....	66	DCCC-626-3.....	88	DFCC-831-2.....	133
4901.....	32	493640.....	105	AROCC-374-4.....	10	CRB-117-2.....	66	DCCC-628-3.....	88	DFCC-831-3.....	133
4902.....	32	494000.....	105	AROCC-377-4.....	10	CRB-117-3.....	66	DCG-613-3.....	88	DFCC-831-4.....	133
4905.....	32	494040.....	105	AROCC-600-3.....	7	CRB-118-2.....	66	DCM-578-3.....	80	DFCC-832-2.....	133
4912.....	31	494080.....	105	AROCC-624-3.....	9	CRB-118-3.....	66	DCR-9930.....	95	DFCC-832-3.....	133
4913.....	31	494160.....	105	AROCC-644-3.....	9	CRB-119-2.....	66	DDL-143-2.....	73	DFCC-832-4.....	133
4918.....	31	494200.....	105	AROCC-644-4.....	9	CRB-119-3.....	66	DDL-343-2.....	73	DFCC-833-3.....	133
4928.....	29	494240.....	105	AROCC-645-3.....	8	CRB-120-2.....	66	DFC-045-1.....	90	DFCC-833-4.....	133
4929.....	29	494400.....	105	AROCC-646-3.....	6	CRB-120-3.....	66	DFC-045-2.....	90	DFCC-834-2.....	133
9927.....	15	494440.....	105	AROCC-646-4.....	6	CS.....	119	DFC-046-1.....	90	DFCC-834-3.....	133
320009.....	122	494480.....	105	AROCC-648-4.....	10	CSCG.....	119	DFC-046-2.....	90	DFCC-834-4.....	133
320010.....	122	494640.....	105	AROCC-664-3.....	6	CSU-5132.....	108	DFC-054-1.....	90	DFCC-835-2.....	133
320011.....	122	495000.....	105	AROCC-665-4.....	7	CSU-5133.....	108	DFC-054-2.....	90	DFCC-835-3.....	133
320012.....	122	495040.....	105	AROCC-667-3.....	8	CSU-5134.....	108	DFC-104-1.....	90	DFCC-835-4.....	133
320013.....	122	495080.....	105	AROCC-677-4.....	10	CSU-5135.....	108	DFC-104-2.....	90	DFCC-836-3.....	133
320014.....	122	495160.....	105	AROCC-685-3.....	9	CSU-5136.....	108	DFC-121-1.....	89	DFCC-836-4.....	133
320015.....	122	495200.....	105	AROCC-685-4.....	9	CSU-5137.....	108	DFC-121-2.....	89	DFCC-837-3.....	133
320016.....	122	495240.....	105	B		CSU-5138.....	108	DFC-122-1.....	89	DFCC-840-2.....	86
320017.....	122	495400.....	105	BBL-321-5.....	71	CSU-5139.....	108	DFC-122-2.....	89	DFCC-840-3.....	86
320018.....	122	495440.....	105	BBL-621-5.....	71	CSU-8132.....	108	DFC-123-1.....	89	DFCC-841-2.....	86
320019.....	122	495480.....	105	BBLCC-620-5.....	71	CSU-8133.....	108	DFC-123-2.....	89	DFCC-841-3.....	86
320020.....	122	495640.....	105	BGS-555-2.....	18	CSU-8134.....	108	DFC-125-1.....	89	DFCC-842-2.....	86
323000.....	104	495650.....	103	BGS-565-2.....	18	CSU-8135.....	108	DFC-125-2.....	89	DFCC-842-3.....	86
324000.....	104	495660.....	103	BGS-575-2.....	18	CSU-8136.....	108	DFC-126-1.....	89	DFCC-843-2.....	86
325100.....	104	495670.....	103	BGS-675-2.....	18	CSU-8137.....	108	DFC-127-1.....	89	DFCC-843-3.....	86
333000.....	104	495680.....	103	BGS-685-2.....	18	CSU-8138.....	108	DFC-134-2.....	91	DFCSB-827-2.....	123
334000.....	104	495690.....	103	BGS-775-3.....	18	CSU-8139.....	108	DFC-135-2.....	91	DFCSB-827-3.....	123
336100.....	104	A		BGS-885-3.....	18	CSWBCG.....	119	DFC-136-2.....	91	DFCSB-828-2.....	123
353391.....	112	AA-138-3.....	16	BL-601-3.....	71	CSWBG.....	119	DFC-137-2.....	91	DFCSB-828-3.....	123
353392.....	112	AA-138-4.....	16	BL-601-4.....	71	CT-300.....	17	DFC-138-1.....	91	DFCSF-823-2.....	132
353393.....	112	AC-370-1.....	41	BLCC-602-3.....	71	CWCC-799-3.....	23	DFC-139-1.....	91	DFCSF-823-3.....	132
353394.....	112	AP-217-2.....	62	BLCC-602-4.....	71	CWICC-797-3.....	23	DFC-142-1.....	91	DFCSF-829-1.....	132
353397.....	112	AP-217-3.....	62	BLCC-604-3.....	71	D		DFC-143-1.....	91	DFCSF-889-2.....	132
393391.....	112	AP-232-2.....	62	BLCC-604-4.....	71	DC-243-2.....	61	DFC-144-1.....	89	DFCSF-889-3.....	132
393392.....	112	APR-667-4.....	45	BLG.....	118	DC-243-3.....	61	DFC-144-2.....	89	DFCSF-889-4.....	132
393393.....	112	APRCC-567-4.....	45	BPR-0024.....	83	DC-4601.....	117	DFC-145-1.....	89	DFCWB-027-2.....	126
393394.....	112	ARO-282-2.....	64	BPS.....	120	DC-610-3.....	88	DFC-145-2.....	89	DFCWB-027-3.....	126
393397.....	112	ARO-282-3.....	64	BR-598-1.....	33	DCB-612-3.....	88	DFC-147-1.....	89	DFCWB-028-2.....	126
491200.....	106	ARO-356-3.....	6	BR-598-2.....	33	DCCC-390-2.....	87	DFC-147-2.....	89	DFCWB-028-3.....	126
491210.....	106	ARO-371-4.....	10	C		DCCC-390-3.....	87	DFC-148-1.....	89	DFCWB-055-2.....	125

Index

Form	Page	Form	Page	Form	Page	Form	Page	Form	Page	Form	Page
DFCWB-055-3.....	125	DFPC-089-4.....	132	ENV-9839.....	98	FM-9922.....	19	GP-158-3.....	51	GS-654-2.....	50
DFCWB-057-2.....	125	DFPC-099-2.....	132	ENV-9840.....	98	FM-9923.....	19	GP-159-2.....	52	GS-654-3.....	50
DFCWB-057-3.....	125	DFPC-099-3.....	132	ENV-9854.....	92	FM-9924.....	19	GP-159-3.....	52	GSA-210-2.....	57
DFCWB-060-2.....	126	DFPC-099-4.....	132	ENV-9855.....	92	FM-9931.....	19	GR.....	118	GSA-210-3.....	57
DFCWB-060-3.....	126	DH-3091.....	107	ENV-9856.....	92	FM-9932.....	19	GRCC-694-2.....	34	GSA-244-2.....	63
DFCWB-062-2.....	126	DH-3099.....	107	ENV-9857.....	92	FM-9933.....	19	GRG.....	118	GSA-244-3.....	63
DFCWB-062-3.....	126	DM-577-3.....	80	ENV-9868.....	26	FM-9934.....	19	GRO-663-3.....	45	GSCC-552-3.....	50
DFCWB-066-2.....	126	DRCC-642-2.....	72	ENV-9869.....	26	FM-9935.....	19	GROCC-563-3.....	45	GSCC-652-2.....	50
DFCWB-066-3.....	126	DRCC-642-3.....	72	ENV-9901.....	100	FM-9936.....	19	GS-201-2.....	59	GSCC-652-3.....	50
DFCWB-068-2.....	126	DSA-115-3.....	5	ENV-9905.....	100	FM-9941.....	19	GS-201-3.....	59	GSCC-652-4.....	50
DFCWB-068-3.....	126	DSA-115-4.....	5	ENV-9906.....	100	FM-9942.....	19	GS-201-4.....	59	GSCC-653-2.....	50
DFCWB-070-2.....	127	DSA-115-3-NC.....	5	ENV-9907.....	100	FM-9944.....	19	GS-202-2.....	55	GSCC-653-3.....	50
DFCWB-070-3.....	127	DSA-115-4-NC.....	5	ENV-9908.....	100	FM-9945.....	19	GS-202-3.....	55	GSCC-670-2.....	51
DFCWB-072-2.....	127	DT-400-2.....	93	ENV-9909.....	100	FM-9946.....	19	GS-202-4.....	55	GSCC-670-3.....	51
DFCWB-072-3.....	127	DT-400-3.....	93	ENV-9910.....	100	FMT-897-3.....	15	GS-203-2.....	58	GSCC-670-4.....	51
DFCWB-083-2.....	127	DT-410-2.....	93	ENV-9911.....	100	FMTCC-898-3.....	15	GS-203-3.....	58	GSD-204-2.....	56
DFCWB-083-3.....	127	DT-410-3.....	93	ENV-9912.....	100	FORM59-3.....	4	GS-203-4.....	58	GSD-204-3.....	56
DFCWB-088-2.....	127	DT-411-2.....	93	ENV-9913.....	100	FPCC-766-3.....	44	GS-209-2.....	57	GSDCC-643-2.....	50
DFCWB-088-3.....	127	DT-411-3.....	93	ENV-9914.....	100	FR-248-2.....	61	GS-209-3.....	57	GSF-214-2.....	26
DFCWB-090-2.....	128	DT-412-2.....	93	ENV-9915.....	101	FR-248-3.....	61	GS-215-2.....	59	GSF-214-3.....	26
DFCWB-090-3.....	128	DT-412-3.....	93	ENV-9916.....	101			GS-215-3.....	59	GSF-221-2.....	26
DFCWB-092-2.....	128	DT-413-1.....	94	ENV-9917.....	101	G		GS-222-3.....	56	GSF-221-3.....	26
DFCWB-092-3.....	128	DT-414-1.....	94	ENV-9918.....	101	GC-779-1.....	114	GS-223-2.....	57	GSF-229-2.....	26
DFCWB-095-2.....	128	DT-415-1.....	94	ENV-9919.....	101	GC-779-2.....	114	GS-223-3.....	57	GSF-229-3.....	26
DFCWB-095-3.....	128	DT-416-1.....	94	ENV-9937.....	101	GC-780-2.....	115	GS-224-2.....	56	GSF-239-2.....	26
DFCWB-097-2.....	128	DT-417-1.....	92	ENV-9938.....	101	GC-781-2.....	115	GS-224-3.....	56	GSFCC-639-3.....	26
DFCWB-097-3.....	128	DT-417-2.....	92	ENV-9939.....	101	GC-782-2.....	115	GS-226-2.....	55	GSFCC-649-3.....	26
DFCWB-824-2.....	127	DT-417-3.....	92	ENV-9940.....	96	GC-783-2.....	115	GS-226-3.....	55	GSR-225-2.....	62
DFCWB-824-3.....	127	DTJ-430-3.....	40	ENV-9955.....	96	GC-784-3.....	114	GS-227-2.....	60	GSR-225-3.....	62
DFCWB-824-4.....	127	DTJ-431-3.....	40	ENV-9956.....	96	GC-785-2.....	115	GS-227-3.....	60		
DFCWB-826-2.....	126			ENV-9957.....	96	GC-786-2.....	115	GS-228-2.....	59	H	
DFCWB-826-3.....	126	E		ENV-9958.....	96	GC-787-2.....	115	GS-228-3.....	59	HAC-680-3.....	21
DFCWB-826-4.....	126	ECO-674-3.....	14	ENV-9959.....	96	GC-788-2.....	115	GS-230-2.....	60	HAC-681-3.....	21
DFCWB-884-2.....	127	ECO-674-4.....	14	ENV-9960.....	39	GC-790-2.....	115	GS-230-3.....	60	HAC-684-3.....	21
DFCWB-884-3.....	127	ELCC-798-3.....	47	ENV-9961.....	38	GC-791-2.....	115	GS-234-2.....	58	HR-370-2.....	40
DFCWB-886-2.....	126	ENV-4420.....	95	ENV-9962.....	100	GC-792-2.....	115	GS-234-3.....	58	HRCC-365-2.....	41
DFCWB-886-3.....	126	ENV-4421.....	95	ENV-9963.....	100	GC-793-2.....	115	GS-237-2.....	58	HVAC-683-3.....	21
DFMB-020-2.....	123	ENV-9804.....	99	ENV-9964.....	100	GCD-784-5.....	114	GS-237-3.....	58		
DFMB-020-3.....	123	ENV-9805.....	99	ENV-9968.....	39	GJ-212-2.....	27	GS-240-2.....	60	I	
DFMB-034-2.....	123	ENV-9806.....	99	ENV-9969.....	39	GJ-212-3.....	27	GS-240-3.....	60	INV-751-3.....	74
DFMB-034-3.....	123	ENV-9807.....	99	ERO-660-2.....	11	GJ-219-2.....	27	GS-251-2.....	59	INV-751-4.....	74
DFMB-036-2.....	123	ENV-9809.....	99	ERO-660-3.....	11	GJ-219-3.....	27	GS-251-3.....	59	INV-751-5.....	74
DFMB-036-3.....	123	ENV-9810.....	99	EROCC-560-2.....	11	GJ-241-2.....	27	GS-252-2.....	59	INV-752-3.....	74
DFMB-037-2.....	123	ENV-9814.....	99	EROCC-560-3.....	11	GJ-241-3.....	27	GS-252-3.....	59	INV-752-4.....	74
DFMB-037-3.....	123	ENV-9815.....	99	ES-697-2.....	11	GP-139-2.....	52	GS-253-2.....	59	INV-754-2.....	75
DFMB-063-2.....	123	ENV-9816.....	99			GP-139-3.....	52	GS-253-3.....	59	INV-754-3.....	75
DFMB-063-3.....	123	ENV-9818.....	99	F		GP-149-2.....	51	GS-254-2.....	55	INV-754-4.....	75
DFPC-023-2.....	132	ENV-9823.....	99	FCSU-5391.....	108	GP-149-3.....	51	GS-254-3.....	55	INV-764-3.....	75
DFPC-023-3.....	132	ENV-9824.....	99	FCSU-5392.....	108	GP-151-2.....	51	GS-255-2.....	55	INV-764-4.....	75
DFPC-023-4.....	132	ENV-9825.....	99	FCSU-5393.....	108	GP-151-3.....	51	GS-255-3.....	55	INV-764-5.....	75
DFPC-029-2.....	132	ENV-9826.....	99	FCSU-5394.....	108	GP-152-2.....	53	GS-256-2.....	55	INV-781-4.....	76
DFPC-029-3.....	132	ENV-9827.....	99	FCSU-5395.....	108	GP-153-2.....	52	GS-256-3.....	55	INV-781-5.....	76
DFPC-029-4.....	132	ENV-9828.....	99	FCSU-8391.....	108	GP-153-3.....	52	GS-271-2.....	58	INVCC-750-2.....	74
DFPC-069-2.....	132	ENV-9829.....	99	FCSU-8392.....	108	GP-154-2.....	51	GS-271-3.....	58	INVCC-750-3.....	74
DFPC-069-3.....	132	ENV-9830.....	99	FCSU-8393.....	108	GP-154-3.....	51	GS-272-2.....	58	INVCC-750-4.....	74
DFPC-069-4.....	132	ENV-9831.....	98	FCSU-8394.....	108	GP-155-2.....	53	GS-272-3.....	58	INVCC-753-3.....	74
DFPC-079-2.....	132	ENV-9832.....	98	FCSU-8395.....	108	GP-155-3.....	53	GS-273-2.....	58	INVCC-753-4.....	74
DFPC-079-3.....	132	ENV-9833.....	98	FGC-625-1.....	26	GP-156-2.....	54	GS-273-3.....	58	INVCC-755-2.....	75
DFPC-079-4.....	132	ENV-9834.....	98	FH-9977.....	43	GP-156-3.....	54	GS-273-4.....	58	INVCC-755-3.....	75
DFPC-089-2.....	132	ENV-9835.....	98	FH-9979.....	43	GP-157-2.....	54	GS-651-2.....	50	INVCC-755-4.....	75
DFPC-089-3.....	132	ENV-9837.....	98	FH-9980.....	43	GP-157-3.....	54	GS-651-3.....	50	INVCC-757-3.....	76
		ENV-9838.....	98	FM-9921.....	19	GP-158-2.....	51	GS-651-4.....	50	INVCC-758-3.....	76
										INVCC-758-4.....	76

Form	Page	Form	Page	Form	Page	Form	Page	Form	Page	Form	Page
INVCC-759-3	76	LS-5744	78	OARE-9920	15	PSCC-895-3	46	SCCC-381-3	87	STCC-687-2	77
INVCC-760-2	75	LT-584-2	43	OSCC-668-3	17	PSECC-863-3	28	SCCC-382-2	87	STCC-689-2	77
INVCC-760-3	75	LWO-893-1	25	OSCC-669-3	17	PT-165-1	49, 109	SCCC-382-3	87	STCC-689-3	77
INVCC-760-4	75	LWOCC-245-3	28			PT-165-2	49, 109	SCCC-383-2	87	STCC-689-4	77
INVCC-765-2	75	LWOCC-794-3	24			PT-165-3	49, 109	SCCC-383-3	87	STCC-689-5	77
INVCC-765-3	75			P3A3A25	116	PT-165-4	49, 109	SCCC-384-2	87	STOICC-341-3	13
INVCC-765-4	75	M		P3A3A50	116	PT-165-5	49, 109	SCCC-384-3	87	STR-302-1	110
INVCC-765-5	75	MAC-9968	65	P3A8A25	116	PTS-165-1	49, 109	SCCC-480-2	87	STR-302-3	110
INVCC-767-3	75	MAC-9969	65	P3A8A50	116	PTS-165-2	49, 109	SCCC-480-3	87	STR-307-1	109
INVCC-782-4	76	MAC-9970	65	P4A3A25	116	PTS-165-3	49, 109	SCCC-481-2	87	STR-317-2	109
		MAC-9972	65	P4A3A50	116	PTS-165-4	49, 109	SCCC-481-3	87	STR-317-3	109
		MAC-9973	65	PACC-692-3	42	PTS-165-5	49, 109	SCCC-482-2	87	STWCC-313-2	111
J		MAC-9975	65	PACC-693-2	42	PTW-165-1	49, 109	SCCC-482-3	87	STWCC-323-2	111
JI-216-3	61	MB-012-2	52	PC-881-3	22	PTW-165-2	49, 109	SCCC-483-3	87	STWCC-343-3	111
JRE-9947	27	MB-247-2	53	PCCC-880-3	22	PTW-165-3	49, 109	SCCC-484-3	87	STYL	120
JRE-9948	27	MB-258-2	53	PCCC-882-2	22	PTW-165-4	49, 109	SCCC-616-2	88	STYLCL	120
JWO-860-3	48	MB-347-3	53	PCICC-879-2	22	PTW-165-5	49, 109	SCCC-616-3	88	SU-1131	108
JWO-861-3	46	MB-358-3	53	PDE-9949	37			SCCC-617-2	88	SU-3131	108
JWOCC-862-3	46	MC	120	PF-8832	97	Q		SCCC-617-3	88	SU-5131	108
JWOCC-870-3	48	MCF-387-1	38	PF-8833	97	R		SCCC-618-2	88	SU-8131	108
		MCF-387-2	38	PF-8834	97	RA-581-3	35	SCCC-618-3	88	SWO-207-2	49
KBPCC-867-3	44	MCF-389-1	38	PG	120	RACC-582-3	35	SCCC-619-2	88	SWO-207-3	49
KBWCC-871-3	44	MCG	120	PH-211-2	36	RB-9984	95	SCCC-619-3	88	SWO-643-4	13
		MCH-350-1	17	PH-211-3	36	RB-9985	95	SCCC-627-2	88	SWOCC-640-4	13
L		MCH-351-1	17	PH-233-2	36	RB-9987	95	SCCC-627-3	88		
LC-5770	92	MCH-352-1	17	PH-233-3	36	RE-661-3	11	SERO-635-3	20	T	
LC-5771	92	MCH-354-1	17	PHCC-853-2	36	RECC-621-3	11	SEROCC-638-3	20	TC-5031	40
LC-5772	92	MGBC30	106	PLBCC-665-3	47	REQCC-574-3	73	SFCC-740-2	86	TERCC-363-2	41
LC-5776	92	MLCC-800-2	82	PLBCC-955-3	47	RF-640-3	72	SFCC-740-3	86	TI-3513	111
LC-5777	92	MLCC-802-2	82	PLCC-630-2	71	RFCC-641-3	72	SFCC-741-2	86	TL-3509	110
LC-5778	92	MLCC-803-2	82	PLCC-630-3	71	RFI-237	4	SFCC-741-3	86	TOY-115-5-NC	4
LE-791-1	25	MLCC-803-3	82	PLE-9430	71	RM-858-3	81	SFCC-742-2	86	TPR-0026	83
LF-5701	102	MLR-113-2	42	PM-101-2	82	RMCC-848-2	81	SFCC-742-3	86	TPR-0027	83
LF-5702	102	MPACC-736-3	20	PMRCG	121	RMCC-848-3	81	SFCC-745-3	86	TPR-0028	83
LF-5703	102	MPVCC-690-2	14	PMRMC	121	RMCC-868-3	81	SFCC-746-3	86	TR-3510	110
LF-5704	102	MPVCC-690-3	14	PO-700-2	68	RO-673-3	7	SFCC-746-2	86	TRO-638-4	14
LF-5705	102	MPVCC-690-4	14	PO-700-3	68	RO-658-3	8	SFCC-746-3	86	TROCC-633-4	14
LF-5706	102	MRB-109-3	37	PO-700-4	68	ROCC-558-3	8	SFCC-747-2	86	TS	121
LF-5708	102	MRM-810-3	81	PO-701-3	68	ROCC-573-3	7	SFCC-747-3	86	TSCL	121
LF-5709	102	MRM-859-3	81	PO-703-3	68	ROI-694-4	12	SO-620-3	72	TVR-669-4	45
LF-5711	102	MRO-636-3	20	PO-703-4	68	RS	121	S OCC-505-2	12	TVRCC-569-4	45
LF-5712	102	MROCC-634-3	20	POB-311-3	67	RS-242-2	64	S OCC-505-3	12	TWP	118
LF-5713	102	MRPG	118	POB-312-3	67	RS-242-3	64	S OCC-505-4	12		
LF-5714	102	MS-249-2	20	POCC-702-3	68	RSB-142-2	17, 52	S OCC-629-3	72	V	
LF-5715	102	MS-249-3	20	POCC-702-4	68	RSB-142-3	17, 52	S OCC-695-3	12	VC-800-1	34
LF-5716	102			POCC-704-2	68	RSD-141-2	16, 54	SOF-698-3	51	VGEL	119
LF-5718	102	N		POCC-704-3	68	RV-643-3	72	SOFCC-699-3	51	VRA-200-2	35
LF-5719	102	NC-124-2	16, 67	POCC-706-2	69			SP-208-2	63	VRA-231-2	35
LMCC-793-3	25	NC-124-3	16, 67	POCC-706-3	69	S		SP-208-3	63	VRACC-580-2	35
LPC-792-3	24	NC-124-3 FUEL	5	POCC-707-2	68	SA-1506-3	15	SP-238-2	63	VRACC-580-3	35
LS-5730	78	NC-146-2	16	POCC-707-3	68	SA-1506-4	15	SP-238-3	63	VT-245-2	36
LS-5731	78	NC-146-3	16	POCC-707-4	68	SC-607-3	88	SS-213-2	64	VT-246-2	36
LS-5732	78	NP-2000	117	POCC-707-5	68	SC-608-3	88	SS-213-3	64	VTCC-845-2	36
LS-5733	78	NP-2100	117	POCC-708-3	69	SC-609-3	88	SS-236-2	64		
LS-5734	78	NP-2200	117	POCC-717-3	69	SC-611-3	88	SS-236-3	64	W	
LS-5735	78	NP-2300	117	PP-2600	39	SC-614-3	88	ST-678-2	77	WFCC-648-2	26
LS-5736	78	NP-2400	117	PP-2601	39	SCB-115-2	49	ST-686-2	77	WO-662-3	48
LS-5737	78	NP-2500	117	PP-2602	39	SCCA-375-4	13	ST-688-2	77	WOCC-632-3	48
LS-5738	78	NS-247-2	32	PP-2603	39	S CCACC-385-4	13	STB-301-2	110	WOCC-850-3	28
LS-5739	78	O		PR-0023	83	S CCC-380-2	87	STC-305-2	110	WOICC-890-3	46
LS-5740	78	ODOM-103-3	4	PSCC-865-3	28	S CCC-380-3	87	STCC-677-2	77	WOICC-890-4	46
LS-5741	78	ODOM-103-4	4			S CCC-381-2	87	STCC-679-2	77	WOICC-891-2	28
LS-5742	78									WOICC-891-3	28
LS-5743	78										

Index - By Product Name

Form	Page
A	
Appliance Repair Form.....	45
Application for Employment.....	40
Attendance Calendar	41
Automotive Forms:	
Buyer's Guide.....	18
Cash Receipt Book.....	16
Commission Voucher.....	4
Daily Time/Job Ticket.....	40
Deal Recap.....	4
Document Jackets.....	96
Emission Control Work Order.....	14
Estimate.....	10-11
Floor Mats - Car.....	19
Floor Mats - Truck.....	19
Fuel Meter Ticket.....	15
Fuel Purchase Order Book.....	5
Heating & Air.....	21
Multi-Point Vehicle Inspection.....	14
Odometer Disclosure.....	4, 17
Overnight Auto Repair Envelope.....	15
Purchase Order Book.....	16
Repair Order.....	6-11
Road Service Book.....	16-17, 54
Smog Control Order.....	13
Special Order Form.....	12
Special Parts Order Form.....	5
Toyota Special Parts Order Form.....	4
Transmission Repair.....	14
We Owe.....	15
Weekly Service Appt. Pad.....	15
B	
Bi-Lingual Forms:	
Buyer's Guide.....	18
General Sales.....	50,56
Guest Checks/Restaurant.....	29
Invoice.....	75
Purchase Order.....	69
Register Form.....	56
Bills of Lading.....	70-71
Business Cards.....	103-106
Buyers Guides.....	18
C	
Calendars.....	41, 116
Cards:	
Business Cards.....	104-106
Punch Cards.....	117
Magnetic Business Cards.....	106
Cash Receipt Books.....	16, 66
Change Order.....	43
Checks:	
Accounts Payable.....	87-88
Check Binder.....	95
Design-A-Form™.....	86
Dual Purpose.....	87-88

Form	Page
General Expense - 3-on-a-page.....	89-91
Laser Checks.....	92
Payroll - 3-on-a-page.....	89-91
Select-A-Style.....	84-85
Cleaning Forms.....	23
Collection Forms.....	79
Credit Memos.....	80
Custom Forms:	
Books.....	123-129
Book Covers.....	124
Design-A-Form™.....	133
Manifold Books.....	123
One-Part.....	132
Ready-To-Go.....	125-131
Snap-A-Part.....	132
Twin Loop Wire Bound Bks.....	125-129
D	
Daily Cash Report Envelope.....	95
Daily Time/Job Ticket.....	40
Debit Memo.....	80
Delivery Receipts.....	72
Deposit Tickets.....	92-94
Design-A-Form™.....	86, 133
Document Jackets.....	96
Door Hangers:	
Custom/Imprinted.....	107
Preprinted.....	107
Driver's Log Book.....	73
DVD Rental.....	35
E	
Electrical Forms.....	47
Envelopes:	
Automotive Invoice.....	100
Business Reply.....	99
Catalog/Booklet.....	98
Checks.....	92, 100
Daily Cash Report.....	95
General.....	99-101
Jewelry Repair.....	27
Kraft First Class.....	98
Overnight Auto Repair.....	15
Medical Claim.....	38-39
Packing List.....	71
Pill/Drug Envelope.....	37
Recycled.....	100
Self Sealing.....	101
Stationery.....	103-105
Teller Helper Envelopes.....	95
Tyvek Catalog.....	98
Tyvek First Class.....	98
Estimates:	
Auto.....	10-11
Kitchen/Bath.....	44
Landscaping.....	25
Protection.....	28
Repair.....	10-11, 45

Form	Page
F	
Floor Mats.....	19
Florist Gift Cards and Envelopes.....	26
Florist Sales Forms.....	26
Form Holders.....	24, 43
Framing Form.....	61
Freight Bill.....	71
Fuel Meter Ticket.....	15
G	
General Repair Forms.....	45
Gift Certificates.....	114-115
Gift Certificate Display.....	114-115
Glass Work Order.....	46
Guest Checks.....	29-33
Guest Checks - Bar.....	29
Guest Checks - Bi-lingual.....	29
H-I	
Health Forms.....	37-39
Hotel Registration.....	34
Human Resource Forms.....	40-41
HVAC Forms.....	21
Inventory Tags.....	111
Invoices:	
Bi-Lingual.....	75
Janitorial.....	23
Job.....	61
Lawn Maintenance.....	24-25
Locksmith.....	28
Pest Control.....	22
Protection.....	28
Snap-A-Parts.....	74-76
J-L	
Janitorial Forms.....	23
Jewelry Repair Register.....	27
Job Work Orders.....	See Work Order
Key Card Holders.....	34
Kitchen/Bath Remodeling Forms.....	44
Labels, Laser.....	112
Labels, Mailing.....	113
Landscaping Forms.....	24-25
Laser/Inkjet Cut Sheets.....	78, 102
Layaway Tags.....	110
Letterhead.....	103-105
Letter of Transmittal.....	43
Locksmith Form.....	28
M	
Magnetic Business Card.....	106
Manifold Books.....	123
Marine Forms.....	20
Material/Labor Record.....	42
Medical Forms.....	37-39
Memos:	
Collection.....	79
Credit.....	80
Debit, Debit/Credit.....	80
Phone.....	82

Index - By Product Name

Form	Page
Memo Letters.....	82
Message/Reply.....	81
Motorcycle Repair.....	20
Multiform Books.....	124-129
N-O	
Note Pads.....	116-117
Odometer Disclosure.....	17
Office Supplies:	
Phone Memo Book.....	82
Pressure Sensitive Labels.....	112-113
Self Inking Stamps.....	122
Thermal Rolls.....	83
Writing Instruments.....	118-121
P	
Packing List:	
Envelopes.....	71
Packing List Form.....	71
Pens and Pencils.....	118-121
Pest Control Forms.....	22
Pharmacy Forms.....	36
Phone Memos.....	82
Plumbing Work Order.....	47
Pool Services.....	46
Prescription Pads.....	39
Presentation Folders.....	97
Pressure Sensitive Shipping Labels.....	112-113
Promotional Advertising.....	106, 116, 118-121
Proposals.....	23-24, 42
Proposal/Acceptance.....	42
Protection/Security Forms.....	28
Punch Cards.....	117
Purchase Orders:	
Bi-Lingual.....	69
Snap-A-Part.....	68-69
Twin Loop Wire Bound Bks 3 and 4-on-a-page.....	16, 67
Q	
Quotation Form.....	42
R	
Ready-To-Go Forms.....	125-131
Receiving Forms.....	72
Register Forms:	
Apparel.....	62
Auto Service.....	63
Bi-Lingual.....	56
Credit Memo.....	80
Dry Cleaners.....	61
Florist Sales.....	26
Framing/Matting.....	61
General Sales.....	55-60
Gift/Jewelry.....	27
Job Invoice.....	61
Locksmith.....	28
Marine.....	20

Form	Page
Pharmacy.....	36
Retail Sales.....	62
Road Service.....	64
Service Station.....	64
Service Work Order.....	49
Stock Parts.....	63
Veterinary.....	36
Video/DVD Rental.....	35
Register Machines.....	65
Remodeling.....	44
Rental Agreement.....	35
Repair Orders:	
Appliance Repair.....	45
Auto.....	6-11
General Repair.....	45
Marine Repair.....	20
Motorcycle/Small Engine.....	20
Repair Estimate Order.....	45
Service Order.....	12
Transmission.....	14
Repair Tags.....	109-110
Requisition.....	73
Restaurant Forms:	
Gift Certificates.....	114-115
Guest Checks.....	29-33
Punch Cards.....	117
Return To Vendor.....	72
Road Service Book.....	16-17, 52
S	
Sales Books:	
General.....	51-53
Road Service.....	16, 52, 54
Service Station.....	53
Twin Loop Wire Bound.....	54
Sales Forms:	
Bi-Lingual.....	50, 56
Florist.....	26
General.....	50-51
Retail/DVD/Video Rental.....	35
Sales Order.....	51
Security Protection Forms.....	28
Service Call Book.....	49
Service Order.....	12
Service Work Order.....	49
Shipping Order.....	72
Small Engine Repair.....	20
Smog Forms.....	13
Special Order.....	12
Stamps, Self-Inking.....	122
Statements.....	77-78
Statements, Laser.....	78
Stationery.....	103-105
Sticky Notes.....	116
String (for Tags).....	108

Form	Page
T	
Tags:	
Blank.....	108
Inventory.....	111
Layaway.....	110
Repair.....	109-110
Valet Parking.....	34
Work Order.....	49, 109
Teller Helper Envelopes.....	95
Thermal Rolls.....	83
Time Cards.....	40
Transmission Repair.....	14
V	
Valet Parking Tag.....	34
Veterinary Forms.....	36
Video/DVD Rental.....	35
W	
Wedding Flower Order Form.....	26
Weekly Service Appt. Pad.....	15
Wire (for Tags).....	108
Work Orders:	
Cleaning.....	23
Electrical.....	47
Emissions Control.....	14
General.....	46, 48-49
Glass.....	46
Kitchen/Bath.....	44
Landscaping.....	24-25
Locksmith.....	28
Plumbing.....	47
Pool Services.....	46
Protection.....	28
Service.....	49
Smog Check.....	13
Work Order/Invoice.....	46
Work Order Tags.....	49, 109

Ordering Information

Logos

We will print one of the Stock Logos shown on pages 134 - 136 in this catalog at no additional charge. Logos can be positioned to the left, right, above or below your imprint, dependent on your total imprint size.

The Stock Logos shown in this catalog are only a sample of the hundreds available.

When requesting a stock logo, please specify by ID code.

Special Features

Options listed below meet most special needs for an additional charge. If you need a feature we haven't anticipated, call us!

Booking – \$11.65/M(R)

Carbonless Snap-A-Part Forms can be booked into sets of 50 (stapled through the stub and wrapped with a heavy manila backer).

Padding – \$4.26/M(R)

Guest Checks on page 29 - 33 can be padded into sets (hot-glued together with a hard backer for writing support and security).

Packing (with drilled hole) – \$16.89(R) per 500 sets

Most forms can be shrink-wrapped in sets of 50 with a drilled hole at the top. Just order the item number followed by PK.

Packing (without drilled hole) – See Pricing Below

Most forms can be shrink-wrapped in sets of 50 and 100 without a drilled hole (includes firm chipboard for sturdy packaging).

PKGs in 50's

250–\$11.81 500–\$16.32 1,000–\$23.96(R)

PKG IN 100's

500–\$13.55 1,000–\$19.22 5,000–\$66.89(R)

Extra Imprint Lines – \$18.40(R)

Add additional lines of type (up to six lines) in the body of most imprinted forms.

Proof – \$15.66(R)

We can fax or email a proof to you for any imprinted order.

Digital Press Proof – \$130.05(R)

Starting Numbers (4, 5 and 7 digits) – \$14.70/M(R)

Register Forms must have a seven-digit starting number and are at no extra charge. All other imprinted forms have a six-digit number at no extra charge. Four, five and custom seven-digit numbering is available at an additional charge.

Forms Fulfillment – Call for Details

We will print your special forms in large quantities and warehouse them for you. Upon request, we'll send them with the appropriate branch or location information in quantities as low as 250. It's a convenient money-saver for companies with multiple offices, branches, locations or franchises.

Rush Orders – Call for Details

For orders that can't wait.

Acceptable Programs (PC Based)

QuarkXPress®: Version 7.0 or less.

(Hint: Quark has a command "Collect for Output" that will automatically gather everything needed to successfully output your document.)

Adobe Acrobat Pro®: PDF Files

Adobe Indesign®

Adobe Illustrator®. Save as an EPS file. Create outlines on all fonts.

Adobe PageMaker®. Save as a PageMaker file.

Macromedia® Freehand: version 8.0 or less. Save as an EPS file.

CorelDraw™: Version 12.0 or less. Save as a normal CDR file.

Microsoft® Word 2000: Save as a DOC file. (NOT recommended for forms design)

Microsoft® Excel 2000: Save as a XLS file. (NOT recommended for forms design)

Microsoft® Publisher 2000: Save as a PUBLISHER file.

Photoshop

File Information:

PDF files ARE accepted but files cannot be altered if changes are to be made.

All EPS and TIFF files used in creating the document must be included.

Art must be made to the correct size of the printed piece. Save a copy of each piece to be printed under a different file name. Include a copy of every file used in creating the document. Always keep copies of all files sent to the producing plant, as the plant is not responsible for loss or damage to your electronic media.

Acceptable compressed files: Stuffit Expander and WinZip® 7.0. Some problems have occurred opening Stuffit files.

Digital Press Files:

Print quality PDF files needed or vector artwork. If specific Pantone color is needed must use that pantone swatch when being created. If no swatch is specified will be printed in 4 color process.

Colors:

When assigning a color to art or text, please use spot colors, not process colors unless 4-color process.

File Storage:

Zip disks, compact disks (CD) and e-mail files are accepted.

Note:

Following these instructions does not guarantee the electronic art will output.

If sending electronic media is not possible, please send "unscreened", color separated, black and white camera-ready artwork. Camera-ready artwork is not recommended due to the use of computer-to-plate-process.

