

SFP+ 8.5G 850nm Multimode Optical Transceiver



Description

The BlueOptics® BO35H856S3D SFP+ transceiver is a high performance, cost effective module supporting a datarate up to 8.5Gbps with 300 Meter link length on multimode fiber.

BlueOptics® transceivers are 100% compliant with SFP+ Multi-Source Agreement (MSA).

All BlueOptics® SFP+ transceivers are always equipped with digital diagnostic function compliant to MSA SFF-8472.

Using digital diagnostic, BlueOptics® SFP+ transceivers provide the following real time information:

- Supply voltage
- Laser bias current
- Laser average output power
- Laser received input power
- Temperature

The transceiver consists of five sections: A VCSEL transmitter, a PIN photodiode, a trans-impedance preamplifier (TIA), the LD Driver and the digital diagnostic function.

Applications

- ✓ 2x / 4x / 8x Fibre Channel

Features

- ✓ 8.5Gb/s serial optical interface
- ✓ VCSEL laser transmitter
- ✓ PIN photo-detector
- ✓ Hot-pluggable SFP+ footprint compliant to SFF-8431
- ✓ Duplex LC/UPC type pluggable optical interface
- ✓ 2-wire interface for management
- ✓ Metal enclosure, for lower EMI
- ✓ RoHS compliant and lead-free
- ✓ Single +3.3V power supply
- ✓ Compliant with SFF-8472
- ✓ Case operating temperature
 - Commercial: 0°C to +70°C
 - Extended: -10°C to +80°C
 - Industrial: -40°C to +85°C

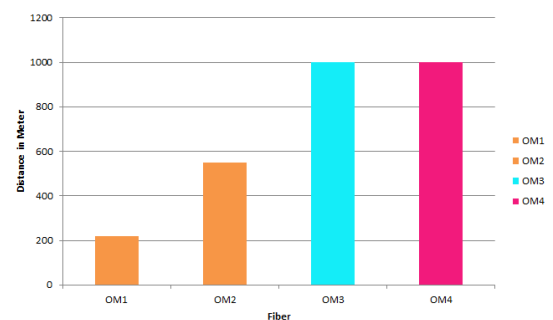

Warnings

Handling Precautions: This device is susceptible to damage as a result of electrostatic discharge (ESD). A static free environment is highly recommended.

Laser Safety: Even small radiation emitted by laser devices can be dangerous to human eyes and lead to permanent eye injuries. Be sure to avoid eye contact with direct or indirect radiation.

Warranty

Every BlueOptics® transceiver comes with a 5 year replacement warranty and lifetime support.

For a warranty inquiry, please contact your CBO sales representative.

This warranty only covers the first user of the equipment.

Important Notice

Performance figures, data and any illustrative material provided in this data sheet are typical and must be specifically confirmed in writing by CBO before they become applicable to any particular order or contract. In accordance with the CBO policy of continuous improvement specifications may change without notice.

The publication of information in this data sheet does not imply freedom from patent or other protective rights of CBO or others.

Further details are available from any CBO sales representative.

Installation

Before installation attach an ESD-preventive wrist to ensure not to damage the transceiver or hardware.

BlueOptics® BO35H856S3D can be installed in any Small Form Factor Pluggable+ (SFP+) port. You can install the BO35H856S3D regardless if the system is powered on or off, because it is hot-swappable.

Insert the transceiver into the SFP port and remove the dust cap.

You can now connect your cable.

Order Information

Part No.	Temp.	DDM
BO35H856S3D	0°C to +70°C	✓
BO35H856S3DEX	-10°C to +80°C	✓
BO35H856S3DIN	-40°C to +80°C	✓

Regulatory Compliance

Feature	Standard	Co.
Electrostatic Discharge (ESD)	- IEC/EN 61000-4- 2	✓
Electromagnetic Interference (EMI)	- FCC Part 15 Class B EN 55022 - Class B (CISPR 22A)	✓
Laser Eye Safety	- FDA 21CFR 1040.10, 1040.11 - IEC/EN 60825-1, 2	Class 1 ✓
Component Recognition	- IEC/EN 60950, UL	✓
RoHS	- 2002/95/EC	✓
EMC	- EN61000-3	✓

1. Absolute Maximum Ratings

Parameter	Symbol	Min.	Typ.	Max.	Unit
Storage Temperature	Ts	-40		85	°C
Storage Ambient Humidity	HA	5		95	%

2. Recommended Operating Conditions

Parameter	Symbol	Min.	Typ.	Max.	Unit	Note	
Case Operating Temperature	Tcase	0		70		BO35H856S3D	
		-10		80	°C	BO35H856S3DEX	
		-40		85		BO35H856S3DIN	
Ambient Humidity	HA	5		70	%		
Transmission Distance				300	M		
Coupled Fiber		Multimode fiber					50/125µm MMF

3. Electrical Interface Characteristics

Parameter	Symbol	Min.	Typ.	Max.	Unit	Note
Power Supply Voltage	Vcc	3.14	3.3	3.46	V	
Signal Input Voltage	Icc			250	mA	
Transmitter						
Input differential impedance	Rin		100		Ω	1
Single ended data input swing	Vin,pp	180		700	mV	
Transmit Disable Voltage	VD	Vcc-1.3		Vcc	V	
Transmit Enable Voltage	VEN	Vee		Vee+0.8	V	2
Transmit Disable Assert Time				10	µs	
Receiver						
Differential data output swing	Vout,pp	300		850	mV	3
Data output rise time	tr	38			Ps	4
Data output fall time	tf	38			Ps	4
LOS Fault	VLOS fault	Vcc-1.3		VccHOST	V	5
LOS Normal	VLOS norm	Vee		Vee+0.8	V	5
Power Supply Rejection	PSR	100			mVpp	6

Notes:

- Internally AC coupled.
- Or open circuit.
- Into 100Ω differential termination.
- 20-80%
- LOS is an open collector output. Should be pulled up with 4.7KΩ on the host board.
- All transceiver specifications are compliant with a power supply sinusoidal modulation of 20 Hz to 1.5 MHz up to specified value through the power supply filtering network shown on page 23 of the Small Form - factor Pluggable (SFP) Transceiver Multi Source Agreement (MSA), September 14, 2000.

4. Transmitter Specifications - Optical

Parameter	Symbol	Min.	Typ.	Max.	Unit	Note
Average Output Power	P _{OUT}	-8.2		-1	dBm	
Extinction Ratio	ER	3			dB	
Center Wavelength	λ _C	840	850	860	nm	VCSEL Laser
Transmitter and Dispersion Penalty	TDP			3.2	dB	
RIN	RIN			-128	dB/Hz	
Transmitter Jitter (peak to peak)	FC-PI-4 rev 7.0					

5. Receiver Specifications - Optical

Parameter	Symbol	Min.	Typ.	Max.	Unit	Note
Input Optical Wavelength	λ _{IN}	840	850	860	nm	
Receiver Sensitivity	P _{IN}			-10	dBm	1
Input Saturation Power (Overload)	P _{SAT}	0.5			dBm	
LOS Assert	P _A	-25			dBm	
LOS De-assert	P _D			-14	dBm	
LOS Hysteresis	P _A -P _D	0.5			dB	

Notes:

1. Measured with Light source 850nm, ER=3dB; BER =<10⁻¹² @PRBS=2³¹ -1 non-return-to-zero.

6. SFP+ to Host Connector Pin Out

Pin	Symbol	Name / Description	Note
1	V _{EET}	Transmitter Ground (Common with Receiver Ground)	1
2	T _{FAULT}	Transmitter Fault indication	2
3	T _{DIS}	Transmitter Disable	3
4	SDA	2-wire Serial Interface Data Line	4
5	SCL	2-wire Serial Interface Clock Line	4
6	MOD-ABS	Module Absent. Grounded within the module	4
7	RS0	Rate Select 0	5
8	LOS	Loss of Signal indication	6
9	RS1	No connection required	1
10	V _{EER}	Receiver Ground (Common with Transmitter Ground)	1
11	V _{EER}	Receiver Ground (Common with Transmitter Ground)	1
12	RD-	Inv. Received Data Out	
13	RD+	Received Data Out	
14	V _{EER}	Receiver Ground (Common with Transmitter Ground)	1
15	V _{CCR}	Receiver Power Supply	
16	V _{CCT}	Transmitter Power	
17	V _{EET}	Transmitter Ground (Common with Receiver Ground)	1
18	TD+	Transmit Data In	
19	TD-	Inv. Transmit Data In	
20	V _{EET}	Transmitter Ground (Common with Receiver Ground)	1

Notes:

1. Circuit ground is isolated from chassis ground.
2. Needs to be pulled up with 4.7k – 10kΩ on host board to a voltage from 2.0V to Vcc + 0.3V.
3. Tx_Disable is an input contact with a 4.7 kΩ to 10 kΩ pullup to VccT inside the module.
4. Mod_ABS is connected to VeeT or VeeR in the SFP+ module. The host may pull this contact up to Vcc_Host with a resistor from 4.7 kΩ up to 10 kΩ.
5. RS1 are module inputs and are pulled low to VeeT with > 30 kΩ resistors in the module.
6. This is an open collector output, which should only be pulled with a resistor of 4.7k - 10kΩ. Pull up voltage between 2.0V and 3.6V. Logic 1 indicates loss of signal; logic 0 indicates normal operation. The output will be pulled to less than 0.8V.

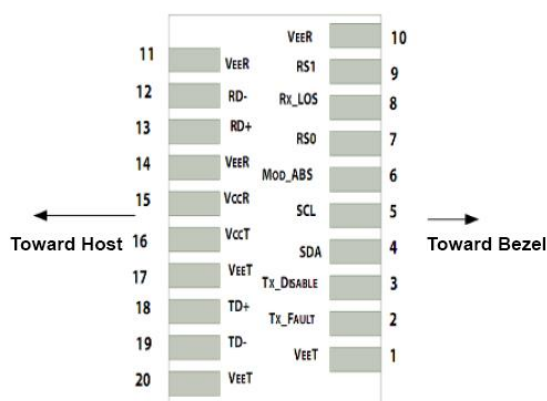

Pinout of Connector Block on Host Board

7. EEPROM Information

The SFP MSA defines a 256-byte memory map in EEPROM describing the transceivers capabilities, standard interfaces, manufacturer, and other information, which is accessible over a 2 wire serial interface at the 8-bit address 1010000X (A0h).

Data Address	Field Size (Bytes)	Name of Field	Contents (Hex)	Description
0	1	Identifier	XX	Formfactor
1	1	Ext. Identifier	XX	
2	1	Connector	XX	
3-10	8	Transceiver	XX XX XX XX XX XX XX XX	Transmittter Code
11	1	Encoding	XX	
12	1	BR, Nominal	XX	Transceiver Speed
13	1	Reserved	00	
14	1	Length (9µm) km	XX	Max. link length in KM
15	1	Length (9µm) 100m	XX	Max. link length in M
16	1	Length (50µm) 10m	XX	Max. link length in M
17	1	Length(62.5µm)10m	XX	Max. link length in M
18	1	Length (Copper)	XX	Max. link length in M
29	1	Reserved	00	
30-35	16	Vendor name	XX XX XX XX XX XX XX XX XX XX XX XX XX XX XX XX	Vendor name - OEM
36	1	Reserved	00	
37-39	3	Vendor OUI	XX XX XX	

40-55	16	Vendor PN	XX XX XX XX XX XX XX XX XX XX XX XX XX XX XX XX	Product Number - depending on Part
56-59	4	Vendor rev	XX XX XX XX	Vendor revision
60-61	2	Wavelength	XX XX	Transceiver Wavelength
62	1	Reserved	00	
63	1	CC BASE	XX	Checksum of bytes 0-62
64-65	2	Options	XX XX	
66	1	BR, max	XX	
67	1	BR, min	XX	
68-83	16	Vendor SN	XX XX XX XX XX XX XX XX XX XX XX XX XX XX XX XX	Part serial number
84-91	8	Vendor date code	XX XX XX XX XX XX 20 20	Year, Month, Day
92	1	Diagnostic type	XX	Diagnostics
93	1	Enhanced option	XX	Diagnostics
94	1	SFF-8472	XX	Diagnostics
95	1	CC_EXT	XX	Checksum of bytes 64-94
96-255	160	Vendor Specific		

8. Digital Diagnostics / Digital Optical Monitoring

The transceiver provides serial ID memory contents and diagnostic information about the present operating conditions by the 2-wire serial interface (SCL, SDA).

The diagnostic information with internal calibration or external calibration are all implemented, including received power monitoring, transmitted power monitoring, bias current monitoring, supply voltage monitoring and temperature monitoring.

9. Recommended Interface Circuit

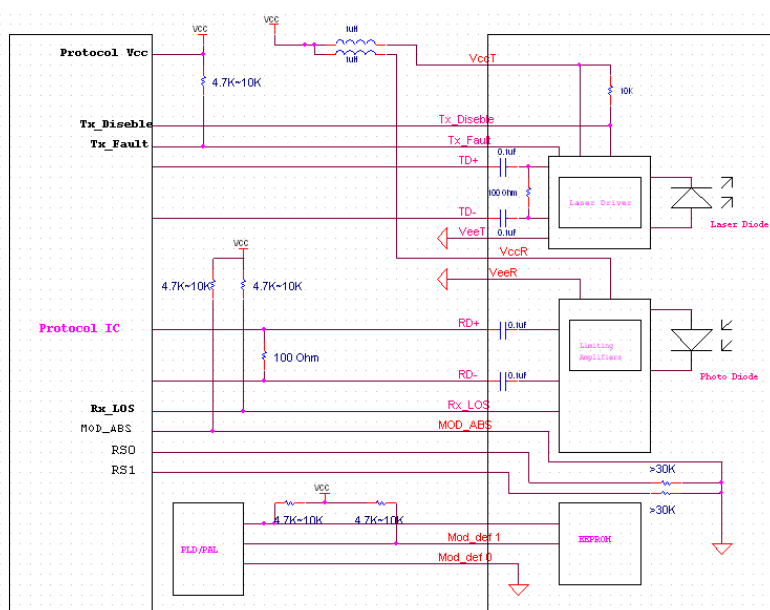

10. Mechanical Specifications (Unit: mm)

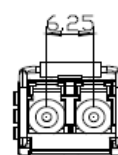
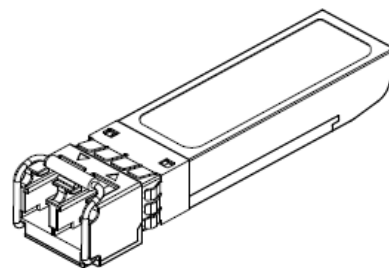
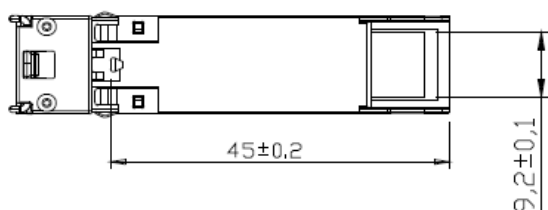
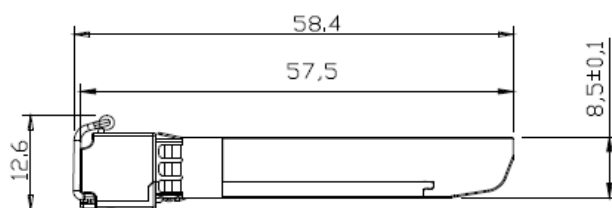
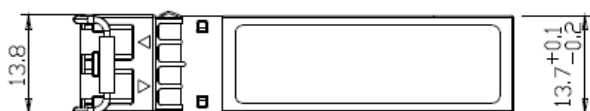

Contact Information

CBO GmbH
Friedhofstraße 25
45478 Mülheim an der Ruhr
Germany

Tel.: 0049 – 208 – 777 247 - 0
Fax.: 0049 – 208 – 777 247 - 99
eMail: info@cbo-it.de
web: www.cbo-it.de