

GBIC 1.25G 1310nm Single mode Optical Transceiver



Description

The BlueOptics® BO01C15210 GBIC transceiver is a high performance, cost effective module supporting a data rate up to 1.25Gbps with 10 Kilometer link length on single mode fiber.

BlueOptics® transceivers are 100% compliant with GBIC Multi-Source Agreement (MSA).

All BlueOptics® GBIC transceivers can be equipped with digital diagnostic function compliant to MSA SFF-8472.

Using digital diagnostic, BlueOptics® GBIC transceivers provide the following real time information:

- Supply voltage
- Laser bias current
- Laser average output power
- Laser received input power
- Temperature

The transceiver consists of five sections: A FP transmitter, a PIN photodiode, a trans-impedance preamplifier (TIA), the LD Driver and the digital diagnostic function.

Applications

- ✓ 1000Base-LX
- ✓ Ethernet / Fiber Channel
- ✓ Switch to Switch Interface
- ✓ Router/Server Interface
- ✓ Other optical links

Features

- ✓ 1.25Gb/s serial optical interface compliant to 802.3z 1000BASE-LX
- ✓ FP laser transmitter
- ✓ PIN photo-detector
- ✓ Hot-pluggable GBIC footprint compliant to SFF-8053
- ✓ Duplex SC/UPC type pluggable optical interface
- ✓ 2-wire interface for management
- ✓ Metal enclosure, for lower EMI
- ✓ RoHS compliant and lead-free
- ✓ Single +3.3V power supply
- ✓ Compliant with SFF-8472
- ✓ Case operating temperature
 - Commercial: 0°C to +70°C
 - Extended: -10°C to +80°C
 - Industrial: -40°C to +85°C

Warnings

Handling Precautions: This device is susceptible to damage as a result of electrostatic discharge (ESD). A static free environment is highly recommended.

Laser Safety: Even small radiation emitted by laser devices can be dangerous to human eyes and lead to permanent eye injuries. Be sure to avoid eye contact with direct or indirect radiation.

Warranty

Every BlueOptics® transceiver comes with a 5 year replacement warranty and lifetime support.

For a warranty inquiry, please contact your CBO sales representative.

This warranty only covers the first user of the equipment.

Important Notice

Performance figures, data and any illustrative material provided in this data sheet are typical and must be specifically confirmed in writing by CBO before they become applicable to any particular order or contract. In accordance with the CBO policy of continuous improvement specifications may change without notice.

The publication of information in this data sheet does not imply freedom from patent or other protective rights of CBO or others.

Further details are available from any CBO sales representative.

Installation

Before installation attach an ESD-preventive wrist to ensure not to damage the transceiver or hardware.

BlueOptics® BO01C15210 can be installed in any Small Form Factor Pluggable (GBIC) port. You can install the BO01C15210 regardless if the system is powered on or off, because it is hot-swappable.

Insert the transceiver into the GBIC port and remove the dust cap.

You can now connect your cable.

Order Information

Part No.	Temp.	DDM
BO01C15210	0°C to +70°C	-
BO01C15210EX	-10°C to +80°C	-
BO01C15210IN	-40°C to +80°C	-
BO01C15210D	0°C to +70°C	✓
BO01C15210DEX	-10°C to +80°C	✓
BO01C15210DIN	-40°C to +80°C	✓

Regulatory Compliance

Feature	Standard	Co.
Electrostatic Discharge (ESD)	- IEC/EN 61000-4- 2	✓
Electromagnetic Interference (EMI)	- FCC Part 15 Class B EN 55022 - Class B (CISPR 22A)	✓
Laser Eye Safety	- FDA 21CFR 1040.10, 1040.11 - IEC/EN 60825-1, 2	Class 1 ✓
Component Recognition	- IEC/EN 60950, UL	✓
RoHS	- 2002/95/EC	✓
EMC	- EN61000-3	✓

1. Absolute Maximum Ratings

Parameter	Symbol	Min.	Typ.	Max.	Unit
Storage Temperature	Ts	-40		85	°C
Storage Ambient Humidity	HA	5		95	%

2. Recommended Operating Conditions

Parameter	Symbol	Min.	Typ.	Max.	Unit	Note
Case Operating Temperature	Tcase	0		70		BO01C15210 BO01C15210D
		-10		80	°C	BO01C15210EX BO01C15210DEX
		-40		85		BO01C15210IN BO01C15210DIN
Ambient Humidity	HA	5		70	%	
Data Rate			1250/1250		Mbps	TX Rate/RX Rate
Transmission Distance				10	KM	
Coupled Fiber		Single mode fiber				9/125µm MMF

3. Electrical Interface Characteristics

Parameter	Symbol	Min.	Typ.	Max.	Unit	Note
Transmitter						
Total Supply Current	I _{CC}			A	mA	1
Transmitter Disable Input-High	V _{DISH}	2		V _{CC} +0.3	V	
Transmitter Disable Input-Low	V _{DISL}	0		0.8	V	
Transmitter Fault Input-High	V _{TXFH}	2		V _{CC} +0.3	V	
Transmitter Fault Input-Low	V _{TXFL}	0		0.8	V	
Receiver						
Total Supply Current	I _{CC}			B	mA	1
LOSS Output Voltage-High	V _{LOSH}	2		V _{CC} +0.3	V	
LOSS Output Voltage-Low	V _{LOSL}	0		0.8	V	

Notes:

1. A (TX) + B (RX) = 300mA (without termination circuit)

4. Transmitter Specifications - Optical

Parameter	Symbol	Min.	Typ.	Max.	Unit	Note
Average Output Power	P _{OUT}	-9		-3	dBm	
Extinction Ratio	ER	9			dB	
Center Wavelength	λ _C	1270	1310	1360	nm	FP Laser
Spectrum Bandwidth(RMS)	σ			3.5	nm	
Transmitter OFF Output Power	P _{Off}			-45	dBm	
Differential Line Input Impedance	R _{IN}	90	100	110	Ohm	
Jitter P-P	t _J			0.1	UI	
Output Eye Mask		Compliant with IEEE802.3z (class 1 laser safety)				

5. Receiver Specifications - Optical

Parameter	Symbol	Min.	Typ.	Max.	Unit	Note
Input Optical Wavelength	λ_{IN}	1270		1610	nm	
Receiver Sensitivity	P_{IN}			-19	dBm	1
Input Saturation Power (Overload)	P_{SAT}	-3			dBm	
LOS Assert	P_A	38			dBm	
LOS De-assert	P_D			-20	dBm	
LOS Hysteresis	P_A-P_D	0.5	2.0	6.0	dB	

Notes:

1. Measured with Light source 1310nm, ER=9dB; BER = $<10^{-12}$ @PRBS=2⁷-1 non-return-to-zero.

6. GBIC to Host Connector Pin Out

Pin	Symbol	Name / Description	Note
1	V_{EET}	Transmitter Ground (Common with Receiver Ground)	1
2	T_{FAULT}	Transmitter Fault indication	
3	T_{DIS}	Transmitter Disable	2
4	MOD_DEF(2)	Module Definition 2. Data line for Serial ID.	3
5	MOD_DEF(1)	Module Definition 1. Data line for Serial ID.	3
6	MOD_DEF(0)	Module Definition 0. Data line for Serial ID.	3
7	RS0	Rate Select 0	
8	LOS	Loss of Signal indication	4
9	V_{EER}	Receiver Ground (Common with Transmitter Ground)	1
10	V_{EER}	Receiver Ground (Common with Transmitter Ground)	1
11	V_{EER}	Receiver Ground (Common with Transmitter Ground)	1
12	RD-	Inv. Received Data Out	
13	RD+	Received Data Out	
14	V_{EER}	Receiver Ground (Common with Transmitter Ground)	1
15	V_{CCR}	Receiver Power Supply	
16	V_{CCT}	Transmitter Power	
17	V_{EET}	Transmitter Ground (Common with Receiver Ground)	1
18	TD+	Transmit Data In	
19	TD-	Inv. Transmit Data In	
20	V_{EET}	Transmitter Ground (Common with Receiver Ground)	1

Notes:

1. Circuit ground is internally isolated from chassis ground.
2. TDis is an input that is used to shut down the transmitter optical output. It is pulled up within the module with a 4.7k~10k Ω resistor. Its states are:
 Low (0 to 0.8V): Transmitter on
 (>0.8V, < 2.0V): Undefined
 High (2.0 to 3.465V): Transmitter Disabled
 Open: Transmitter Disabled
3. Mod-Def 0,1,2. These are the module definition pins. They should be pulled up with a 4.7k~10k Ω resistor on the host board. The pull-up voltage shall be VccT or VccR.
 Mod-Def 0 is grounded by the module to indicate that the module is present
 Mod-Def 1 is the clock line of two wire serial interface for serial ID
 Mod-Def 2 is the data line of two wire serial interface for serial ID

- LOS is an open collector output, which should be pulled up with a 4.7k~10kΩ resistor. Pull up voltage between 2.0V and Vcc+0.3V. Logic 1 indicates loss of signal; Logic 0 indicates normal operation. In the low state, the output will be pulled to less than 0.8V.

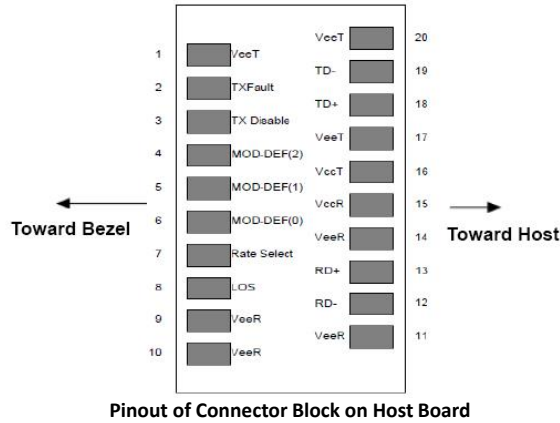

7. EEPROM Information

The GBIC MSA defines a 256-byte memory map in EEPROM describing the transceivers capabilities, standard interfaces, manufacturer, and other information, which is accessible over a 2 wire serial interface at the 8-bit address 1010000X (A0h).

Data Address	Field Size (Bytes)	Name of Field	Contents (Hex)	Description
0	1	Identifier	XX	Formfactor
1	1	Ext. Identifier	XX	
2	1	Connector	XX	
3-10	8	Transceiver	XX XX XX XX XX XX XX XX	Transmittter Code
11	1	Encoding	XX	
12	1	BR, Nominal	XX	Transceiver Speed
13	1	Reserved	00	
14	1	Length (9µm) km	XX	Max. link length in KM
15	1	Length (9µm) 100m	XX	Max. link length in M
16	1	Length (50µm) 10m	XX	Max. link length in M
17	1	Length(62.5µm)10m	XX	Max. link length in M
18	1	Length (Copper)	XX	Max. link length in M
29	1	Reserved	00	
30-35	16	Vendor name	XX XX XX XX XX XX XX XX XX XX XX XX XX XX XX XX	Vendor name - OEM
36	1	Reserved	00	
37-39	3	Vendor OUI	XX XX XX	
40-55	16	Vendor PN	XX XX XX XX XX XX XX XX XX XX XX XX XX XX XX XX	Product Number - depending on Part
56-59	4	Vendor rev	XX XX XX XX	Vendor revision
60-61	2	Wavelength	XX XX	Transceiver Wavelength
62	1	Reserved	00	

63	1	CC BASE	XX	Checksum of bytes 0-62
64-65	2	Options	XX XX	
66	1	BR, max	XX	
67	1	BR, min	XX	
68-83	16	Vendor SN	XX XX XX XX XX XX XX XX XX XX XX XX XX XX XX XX	Part serial number
84-91	8	Vendor date code	XX XX XX XX XX XX 20 20	Year, Month, Day
92	1	Diagnostic type	XX	Diagnostics
93	1	Enhanced option	XX	Diagnostics
94	1	SFF-8472	XX	Diagnostics
95	1	CC_EXT	XX	Checksum of bytes 64-94
96-255	160	Vendor Specific		

8. Digital Diagnostics / Digital Optical Monitoring

The transceiver provides serial ID memory contents and diagnostic information about the present operating conditions by the 2-wire serial interface (SCL, SDA).

The diagnostic information with internal calibration or external calibration are all implemented, including received power monitoring, transmitted power monitoring, bias current monitoring, supply voltage monitoring and temperature monitoring.

9. Recommended Interface Circuit

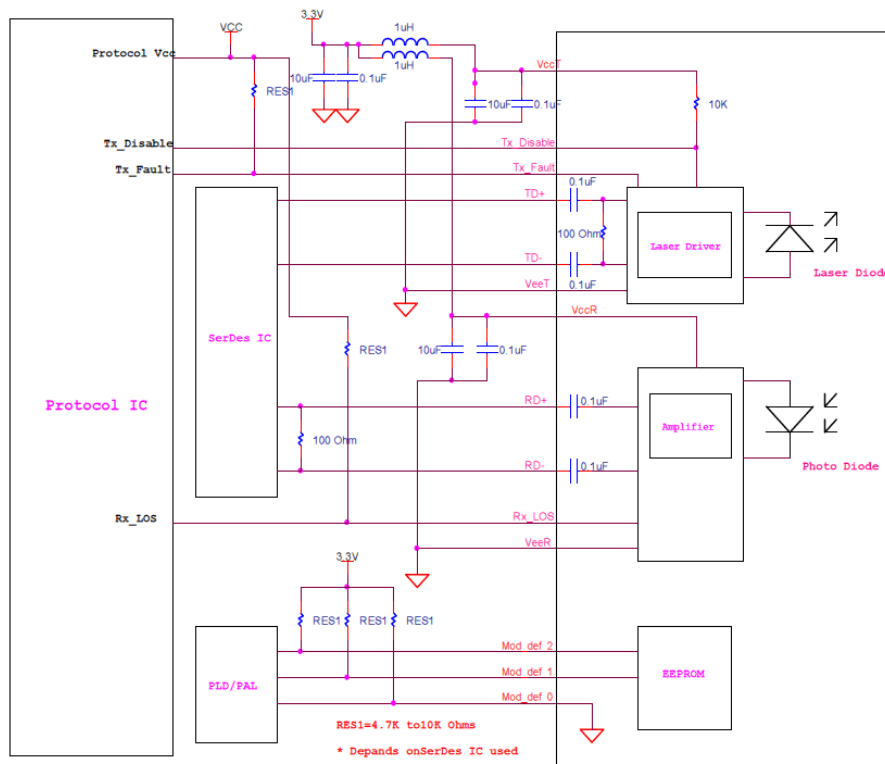

10. Mechanical Specifications (Unit: mm)

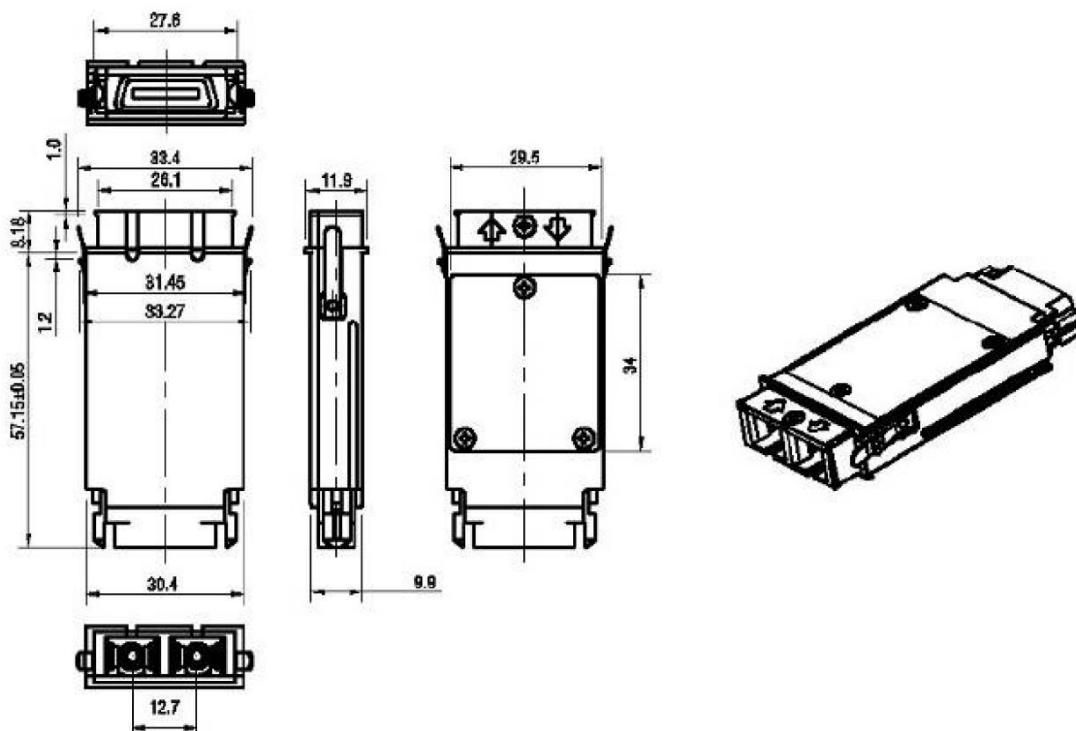

Contact Information

CBO GmbH
Friedhofstraße 25
45478 Mülheim an der Ruhr
Germany

Tel.: 0049 – 208 – 777 247 - 0
Fax.: 0049 – 208 – 777 247 - 99
eMail: info@cbo-it.de
web: www.cbo-it.de