

**Declaration of Conformity**

Electronic Organizer: OZ-730PC/OZ-750PC

This device complies with Part 15 of the FCC Rules.

Operation is subject to the following two conditions: (1) This device may not cause harmful interference, and (2) this device must accept any interference received, including interference that may cause undesired operation.

**WARNING** - FCC Regulations state that any unauthorized changes or modifications to this equipment not expressly approved by the manufacturer could void the user's authority to operate this equipment.

Note: This equipment has been tested and found to comply with the limits for a Class B digital device, pursuant to Part 15 of the FCC Rules.

These limits are designed to provide reasonable protection against harmful interference in a residential installation. This equipment generates, uses, and can radiate radio frequency energy and, if not installed and used in accordance with the instructions, may cause harmful interference to radio communications.

However, there is no guarantee that interference will not occur in a particular installation. If this equipment does cause harmful interference to radio or television reception, which can be determined by turning the equipment off and on, the user is encouraged to try to correct the interference by one or more of the following measures:

- Reorient or relocate the receiving antenna.
- Increase the separation between the equipment and receiver.
- Connect the equipment into an outlet on a circuit different from that to which the receiver is connected.
- Consult the dealer or an experienced radio / TV technician for help.

Note: A shielded interface cable is required to ensure compliance with FCC regulations for Class B certification.

Responsible Party:

SHARP ELECTRONICS CORPORATION  
Sharp Plaza, Mahwah, New Jersey 07430-2135  
TEL: 630-378-3590

Tested To Comply With FCC Standards  
FOR HOME OR OFFICE USE

**FOR YOUR RECORDS....**

For your assistance in reporting this Electronic Organizer in case of loss or theft, please record the model number and serial number (located on the bottom of the case) below.

Please retain this information

Model Number \_\_\_\_\_

Serial Number \_\_\_\_\_

Date of Purchase \_\_\_\_\_

Place of Purchase \_\_\_\_\_



## Introduction

Congratulations on purchasing the OZ-730/OZ-750 Electronic Organizer.

Please read this operation manual thoroughly to familiarize yourself with all the features of the unit and to ensure years of reliable operation. You may also find it useful to keep this operation manual on hand for reference.

Some of the accessories described in this manual may not be available at the time you purchase this Organizer.

Check with your local SHARP dealer concerning availability.

All company and / or product names are trademarks and/or registered trademarks of their respective manufacturers.

Day-Timer® and Day-Timer Organizer® are registered trademarks of Day-Timers, Inc.

Windows® is a registered trademark of Microsoft Corporation.

### Note:

- \* The differences between OZ-730/OZ-750 are memory capacity. Also, the OZ-750 Organizer has an optical communication terminal (IrDA), while OZ-730 does not. The remainder of the functions are common.
- \* Unless otherwise specified, the text and material in this manual applies to both models.

- \* One of the models described in this manual may not be available in some countries.
- \* Some of the accessories described in the manual may be unavailable in some countries.

### NOTICE:

- \* SHARP strongly recommends that you keep separate permanent written records of all important data. Data may be lost or altered in virtually any electronic memory Organizer under certain circumstances. Therefore, SHARP assumes no responsibility for data lost or otherwise rendered unusable whether as a result of improper use, repairs, defects, battery replacement, use after the specified battery life has expired, or any other cause.
- \* SHARP assumes no responsibility, directly or indirectly, for financial losses or claims from third persons resulting from the use of this Organizer and any of its functions, such as stolen credit card numbers, the loss or alteration of stored data, etc.
- \* The information provided in this manual is subject to change without notice.

**The screen examples shown in this manual may not exactly match those of the product.**

For example, although the field name is reversed on the product's screen, the field name on the relevant screen in this manual may not be reversed.



# Contents

<b>Introduction</b> .....	<b>1</b>		
<b>Contents</b> .....	<b>2-3</b>		
<b>Caring for the Organizer</b> .....	<b>4</b>		
<b>Chapter 1 Getting Started</b> .....	<b>5-12</b>		
Part Names and Functions			
Getting the Organizer Up and Running			
Setting up the Organizer after Initialization			
Getting to Know Your Organizer			
<b>Chapter 2 General Operation</b> .....	<b>13-22</b>		
Opening an Application - The First Main Menu			
Selecting the Display Modes			
Creating a New Entry			
Editing an Existing Entry			
Editing Techniques			
Finding Specific Entries in Your Organizer			
Deleting Entries			
Checking the Time and Date			
Checking the Memory			
The Second Main Menu - the Organizer's Basic Utilities			
<b>Chapter 3 Time Management</b> .....	<b>23-30</b>		
The Calendar Application			
The Schedule Application			
The To Do Application			
The Birthday / Ann (Anniversary) Application			
<b>Chapter 4 Creating Your Own Database</b> .....	<b>31-32</b>		
The Tel Application			
<b>Chapter 5 Memo</b> .....	<b>33-34</b>		
The Memo Application			
<b>Chapter 6 Desk Accessories</b> .....	<b>35-42</b>		
The Calc (Calculator) Application			
The Clock Application			
<b>Chapter 7 Expense</b> .....	<b>43-46</b>		
Entering Expense Record			
Expense Report			
<b>Chapter 8 Features and Utilities for Added Power ..</b>	<b>47-50</b>		
Copying or Moving Blocks of Text			
Copying or Moving Entries			
Special Characters			
<b>Chapter 9 Data Transfer</b> .....	<b>51-54</b>		
Transferring Data			
Exchanging Information with a Personal Computer			

<b>Chapter 10 Personalizing Your Organizer .....</b>	<b>55-60</b>
The Start-Up Display	
Setting the Owner's Information	
Locking the Organizer	
Changing the Calendar Display Format	
Assigning Keys for short-cut entry	
Selecting the Large Font View	
<b>Chapter 11 How to use the Add-on .....</b>	<b>61-62</b>
Installing My Programs application	
Setting a My Programs application to Autorun	
<b>Appendices .....</b>	<b>63-67</b>
A. Resetting the Organizer	
All reset operation	
B. Battery Replacement	
General guidelines	
Replacing the operating batteries	
C. Specifications	
<b>Index .....</b>	<b>68-71</b>
<b>Product Support .....</b>	<b>72</b>
<b>Troubleshooting .....</b>	<b>73</b>

## Caring for the Organizer

The Organizer contains sophisticated circuitry and a glass display panel which can be damaged if not handled with care. A few precautions should be taken regarding the Organizer's care to ensure it gives you many years of reliable and trouble-free use.

- \* Keep the Organizer away from extreme heat. Do not leave it on the dashboard of a car or near any source of heat. Do not leave it in any place that is extremely damp or dusty.
- \* Do not drop the Organizer or subject it to severe impact or extreme force. Bending the Organizer unduly can damage it.
- \* Do not use extreme force when pressing the keys. Do not use any sharp, pointed object to press them.

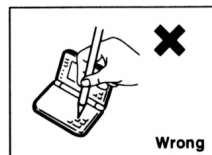
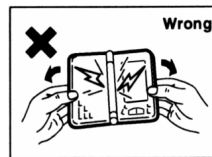
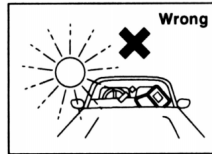

- \* Sharp or hard object can scratch and damage the Organizer. Make sure it is adequately protected when carried with other objects. Do not carry it loose in a bag or briefcase: find a pocket or secure compartment within your bag.

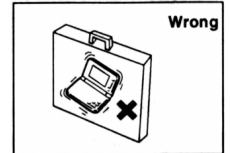

- \* Clean the Organizer only with a soft, dry cloth. Do not use solvents.

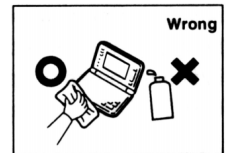

- \* Do not carry the Organizer around in your back pocket, as it may break when you sit down. The display is made of glass and is very delicate.

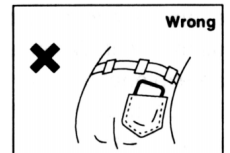

- \* Since this Organizer is not waterproof, do not use it or store it where fluids, for example water, can splash onto it. Raindrops, water spray, juice, coffee, steam, perspiration, etc. will also cause malfunction.
- \* Replace the batteries as soon as they become weak (see p.64). Failing to replace weak batteries may result in leakage or lost data.

# CHAPTER 1 Getting Started

This chapter explains everything you need to know to set up and begin working with your Organizer, from installing the batteries to initialization. The chapter also includes a labeled illustration of the parts of the Organizer, and basic explanation of its key features, from the keyboard to the display and its symbols.

## Part Names and Functions

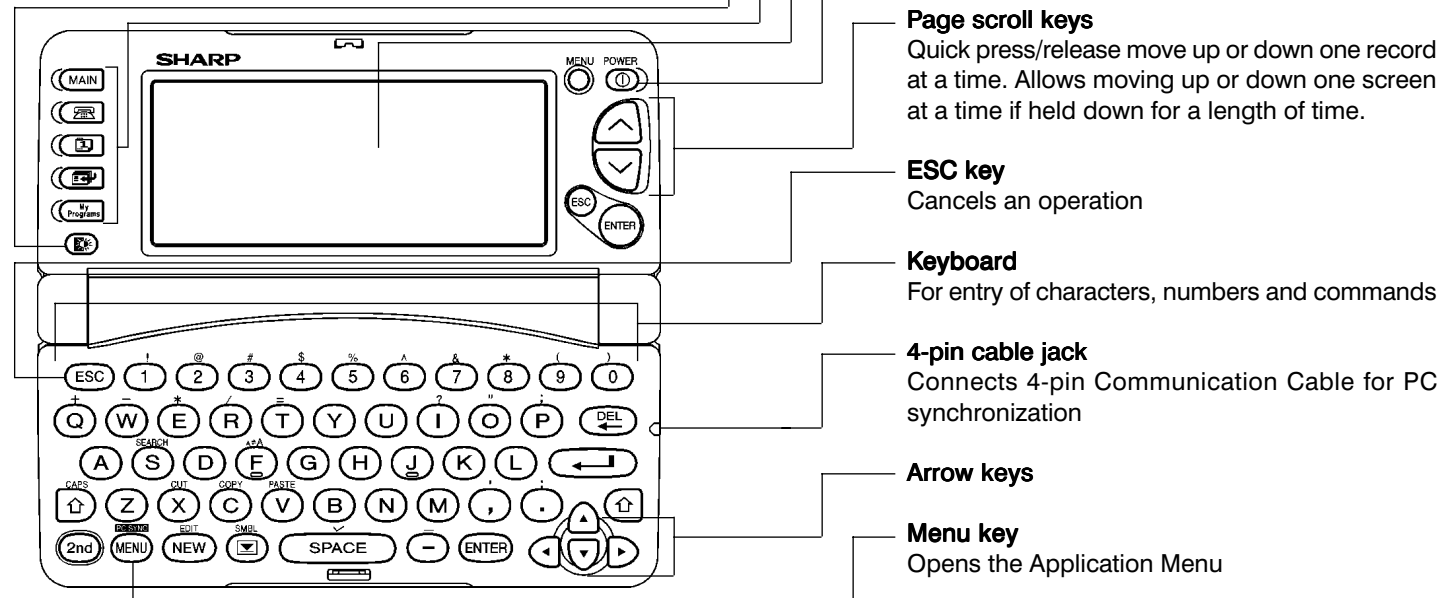

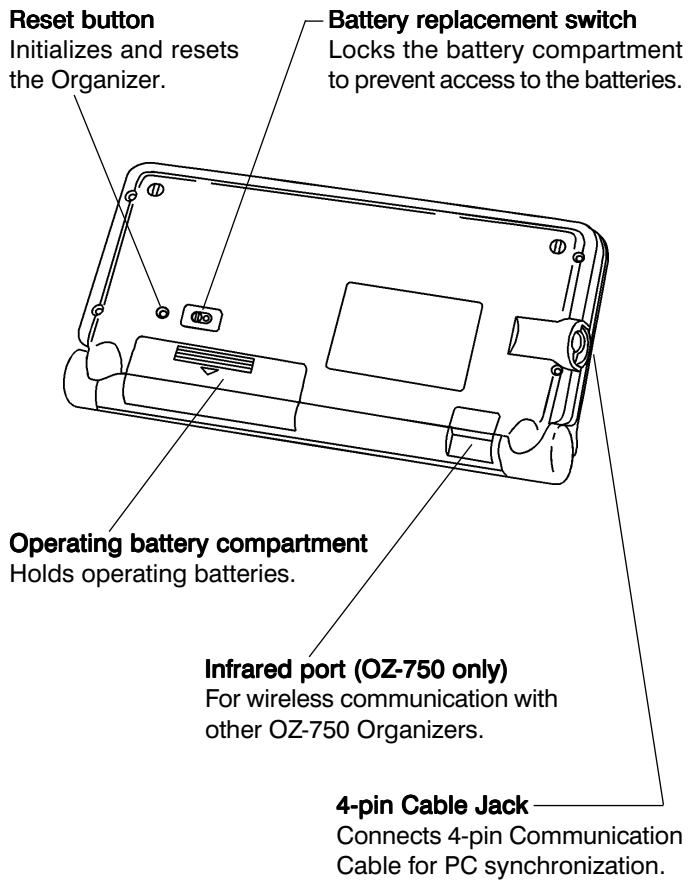

## Getting the Organizer Up and Running

### Installing the batteries

1. Set the battery replacement switch on the bottom of the Organizer to REPLACE BATTERIES (a red dot becomes visible).
2. Slide off the operating batteries cover.

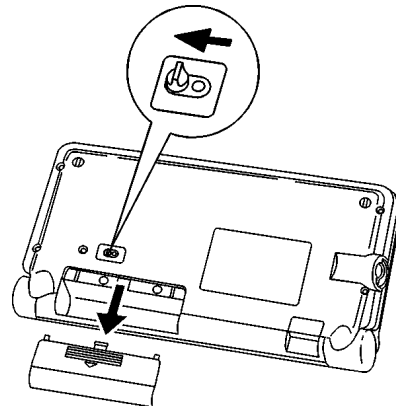

3. Insert two batteries on top of the ribbon tab, making sure they are positioned correctly according to plus (+) and minus (-) polarity, as shown below.

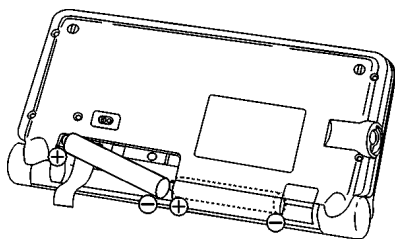

4. Replace the cover.
5. Set the battery replacement switch back to NORMAL OPERATION (the red dot disappears).

 The Organizer will not function unless the battery replacement switch is in the NORMAL OPERATION position.

### Initializing

The Organizer must be initialized when it is used for the first time.

1. Press and hold the **Ⓚ** key.
2. While holding down the **Ⓚ** key, push the RESET button on the bottom of the Organizer using a pen or some other pointed object. The following message will appear.

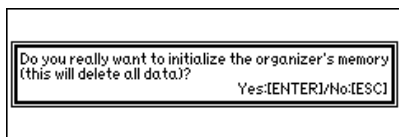

3. Press **[ENTER]** to initialize the Organizer.

The message "Working... Please wait." appears while the Organizer proceeds with the initialization procedure.

The Welcome message then appears.

### Setting up the Organizer after Initialization

The Organizer takes you through the various steps needed to set up the Organizer before use. These steps are described below. We strongly recommend that you complete the entire set up procedure before starting to actually use your Organizer.

- \* Welcome messages and instructions
- \* Setting the display contrast
- \* Setting the clock

### Welcome messages and instructions

After pressing **[ENTER]** to confirm initializing the unit, the Organizer displays the following welcome message, briefly outlining its functions.

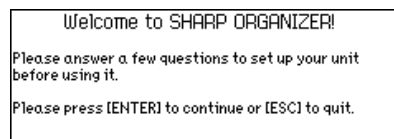

Press **[ENTER]** to proceed to the Basic Instruction screen. Press **[ENTER]** again to proceed with Display Contrast setup screen.



## 8 | Getting Started

### Setting the Display Contrast

If the display is not clear, press  $\uparrow$  or  $\downarrow$  until the display is satisfactory.

Press  $\text{ENTER}$  to proceed with setting up the Clock as described below (or  $\text{ESC}$  to quit the set up procedure).

### Setting the City

In order to make sure that the Calendar, Schedule and other time-based applications work correctly, the built-in clock must be set to the correct time, date and city. When this Organizer is first initialized, the city is automatically set to New York. Before setting the Clock, you should first select the city for which you want to set the time.

After setting the Display Contrast, the following list of cities appears.



1. If the desired city does not appear, press  $\uparrow$   $\downarrow$  to display more cities.

 You can jump to a particular city by pressing the first letter of that country name.

2. Select the desired city by moving the cursor to it and then press  $\text{ENTER}$  to confirm. Or select numbers  $\textcircled{1}$  -  $\textcircled{5}$  directly.

Press  $\text{ENTER}$  to proceed with setting the Time and Date.

### Setting the Time and Date

After selecting the city, the ADJUST TIME / DATE screen appears.

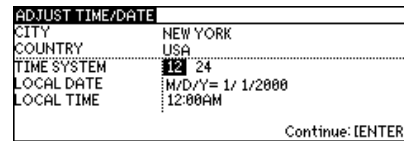

1. Select the time system you want the clock to use by pressing  $\leftarrow$  or  $\rightarrow$ , then press  $\uparrow$  or  $\downarrow$ .
2. In the LOCAL DATE field, press  $\text{F1}$  to display the pop-up calendar. Use  $\uparrow$  and  $\downarrow$  to select the current month, then use the arrow keys to select today's date.
3. Press  $\text{ENTER}$  once and the date has been selected. The pop-up calendar disappears and the date now appears in the LOCAL DATE field.
4. Press  $\downarrow$  to move to LOCAL TIME field. Enter the local time, preceding single-digit hours and minutes with "0". Press  $\text{P}$  to select PM or  $\text{A}$  for AM.

Press  $\text{ENTER}$  to proceed to the Daylight Saving Time screen.

5. If your city is currently on Daylight Saving Time, press  $\leftarrow$  (Yes), otherwise press  $\rightarrow$  (No), then press  $\text{ENTER}$  to confirm.

A new screen then appears to inform you that the basic setup

procedure is now completed, and the Organizer is ready for use. However, there are other areas in which you can customize your Organizer further by setting various options.

### Setting the Start-up Display

You can control the way Organizer behaves each time you turn it on, including the background that appears. You can choose to activate the Autorun function before setting an autorun of My Program application once the Organizer is turned on.

1. Press **My Programs** then press **MENU**. Select AUTORUN in MY PROGRAMS MENU and press **ENTER**.
2. Use **▲▼◀▶** to select application then press **ENTER**.

### Setting the World City

In addition to setting the local city, you can also select the world city, to display the time in another city of your choice alongside the Local time. When the Organizer is initialized, the world city is set to London.

To select the world city:

1. Press **MAIN** twice to enter the Second Main Menu and select CLOCK then press **ENTER**.
2. Press **MENU** to open the Clock menu and select CHANGE WORLD CITY then press **ENTER**.

The CHANGE WORLD CITY screen appears. A list of six capital cities is given, with five cities displayed at one time.

3. If the city you wish to select does not appear in the list, type the first letter of the desired country.
4. Select the desired city by moving the cursor to it and then press **ENTER** or select numbers **1** - **5** directly.

### Setting the Password and Locking the Organizer

The Organizer allows you to keep selected entries in your Organizer secure by locking it with a password. Once the Organizer is locked, the Secret entries cannot be accessed until the Organizer is unlocked, for which the password must be given.

Select this option if you want to define a password and lock the Organizer.

1. Press **MAIN** twice to enter the Second Main Menu.
2. Select Secret then press **ENTER**.
3. Select LOCK ORGANIZER then press **ENTER**.

The Lock Organizer screen appears.

4. Enter the password you wish to use then press **ENTER**.

## 10 | Getting Started

5. Re-type the password to confirm and then press **ENTER**.

A message appears reminding you to remember your password or keep it in a safe place.

6. Press **ENTER**.

The Second Main Menu appears.

### Turning the Organizer on and off

Press **ON** to turn the power on and press **OFF** again to turn the power off. The Organizer will not operate if the battery replacement switch is in the REPLACE BATTERIES position.

### Auto power off

To conserve battery power, the Organizer will turn itself off if it has not been used for about 7 consecutive minutes. However, in order to avoid accidentally interrupting data transfers, the auto power-off function is disabled while communicating with other devices.

If the Organizer's power goes off automatically before an entry you have been working with is stored in an application, the data will not be lost. When you press **ON**, the Organizer will return to the same operating state as before the power turned off automatically.

### Setting the LCD contrast

From time to time, the contrast of the LCD display may have to be adjusted for ideal readability. You may find, for example, that a contrast setting that was fine for the home or office is not

adequate when outdoors or when travelling on public transport. Follow the procedure below adjust the LCD contrast.

1. Press **MAIN** twice to enter the Second Main Menu.
2. Select Contrast then press **ENTER**.
3. Adjust the contrast by pressing **▲** and **▼** or **▲** and **▼**.
4. Press **ENTER** when you are satisfied with the contrast.

### Turning the key beep / alarm sound on and off

The Organizer can be set to make a sound (a beep) each time a key is pressed. This may help you to know whether a key has been pressed properly. The default setting is on. You can use the Second Main Menu to change the setting.

1. Press **MAIN** twice to enter the Second Main Menu.
2. Select Sound then press **ENTER**.
3. Press **◀** / **▶** to choose ON or OFF in KEY SOUND / SCHEDULE ALARM/ DAILY ALARM.
4. Press **▲** / **▼** to move between different options.
5. Press **ENTER**.

### Backlight

The organizer provides a built-in Backlight, which allows you to view the display and use the organizer even in low-light conditions, eg. in a theater, restaurant, or business

presentation. Pressing **☰** once illuminates the display for as long as you continue to use the organizer, until you have not typed any key for about 1 minute or press **☰** again.

Note: Do not use the backlight unnecessarily.

 Since the backlight drains power from the operating batteries, excessive use of the backlight will significantly reduce your battery life.

 Continuous use of the backlight will, over time, lead to gradual loss of brightness.

## Getting to Know Your Organizer

OZ-730/OZ-750 is a compact yet sophisticated information management device that you can use anytime. Its applications and utilities allow you to enter and organize information, and it has powerful communications facilities that enable you to put that information to optimum use when you return to your home or office. You can quickly update your computerized mailing lists, for example, or even transfer your notes, letters and memos onto a PC for further processing.

### Applications

Operations on the Organizer are performed using applications. The Organizer's Calendar and Schedule, for example, are applications that record and display time related information. To start an application, select the application in the Main Menu or press the Application keys on the left of the screen (Main / Tel / Schedule / Memo / My Programs).

When working in one application, you can switch to another application simply by pressing that application key (Main / Tel / Schedule / Memo / My Programs only). Data being processed in the first application will be kept, even if the entry is not complete.

### Menu operations

Another powerful aspect of using the Organizer is its menu system, which can be used to quickly issue commands and perform operations. Press **☰** once displays the application menu, which contains the operations and commands specific to the particular application.



### Pop-up menus

The Organizer's pop-up menus offer a convenient and efficient method of selecting options from pre-defined lists, similar to many of the latest personal computer application software packages. Most applications and functions contain some pop-up fields. When the user moves to one of these fields, the pop-up symbol appears on the right of the field. Pressing **☰** causes the pop-up menu to appear, containing a list of options or values currently available for that field. You can then select the desired item from the list without having to type any text.

In addition, all date fields function as pop-up fields. Where a date can be entered, the user can press **☰** to display the



## CHAPTER 2

# General Operation

This chapter introduces most of the Organizer's basic operations. The Tel application will be used for the examples. However, most of the techniques described here can be applied to all of the Organizer's applications.

## Opening an Application - The First Main Menu

To start an application, press **MAIN** to enter the Main Menu to select the application or simply press the application key located on the left of the display. Press **MAIN** / **☰** / **☰** / **☰** / **Programs**, the selected application will appear. Any application already being displayed will be hidden whenever a new application is selected. You can always return to another application at the exact point where you left off simply by pressing its key again. However, only one application can be displayed at a time.

### Main Menu

JAN 1, 2000 (SAT)	12:00AM	1/2
1 <b>Calendar</b>	6 <b>Memo</b>	
2 <b>Schedule</b>	7 <b>Expense</b>	
3 <b>Birthday/Ann</b>	8 <b>Calc</b>	
4 <b>To Do</b>	9 <b>Conversion</b>	
5 <b>Tel</b>		

## Selecting the Display Modes

Once an application is open, you can switch between three basic display modes: Index, View and Edit. Each display mode has its own unique appearance and particular purpose. Index mode is normally the default view when an application is opened, and provides a summary of the individual entries that have been created. Pressing **ENTER** after selecting a particular entry causes the entry to be displayed in View mode, which shows the full details of the entry. During View mode, no entry details may be altered.

Pressing **2nd** **NEW** either when an entry is displayed in View mode or is selected in Index Mode, causes the entry to be displayed in Edit mode. The entry's details can then be altered as desired. Edit mode is also used when a new entry is being created (by pressing **NEW**).







### Index mode

The Index mode shows you a list view of the entry within the application. This allows you to easily find a particular entry, which you can then display in full (View mode) by pressing **ENTER**.

TEL	<BUSINESS >	
Brown,Bill	201-496-8574	Swift Corporation
Brown,Charlie	812-254-1813	Soap Corporation
Curren, Tom	212-654-6544	SHARP Corporation
Harris, Keith	212-555-5550	SHARP Corporation
Jackson, Thomas	201-635-6657	SHARP Corporation
Jones, Pat	201-555-6546	SHARP Corporation

## 14 | General Operation

### Other operations:



-  Creates a new entry for the current application (in Edit mode).
-  Displays the currently selected entry and edits it (Edit mode).
-  Deletes the currently selected entry.
-  Displays any previous/subsequent entries not shown.
-  Selects an entry
-  Displays category menu and user can select a category





### View mode

View mode allows you to see the full details of an entry, without being able to edit or change it.

TEL		< BUSINESS >	
NAME	:	Pat, Jones	
COMPANY	:	SHARP Corporation	
TITLE	:	Supervisor	
OFFICE#	:	201-555-6546	
FAX#	:	201-555-6547	

### Other operations:

-  Creates a new entry for the current application (in Edit mode).
-  Edits the currently displayed entry.



-  Deletes the currently selected entry.
-  Displays any previous/subsequent entries not shown.
-  Displays any information not shown within an entry.
-  Switches to Index mode.

### Edit mode

Edit mode is used to create a new entry or edit an existing entry.

TEL	
CATEGORY	: BUSINESS
LAST NAME	: Pat
FIRST NAME	: Jones
COMPANY	: SHARP Corporation
TITLE	: Supervisor
OFFICE#	: 201-555-6546
FAX#	: 201-555-6547

### Other operations:

-  When you cancel your changes to the data in edit mode, "Do you really want to throw away all of these changes? Yes: [ENTER] / No: [ESC]" will be shown for confirmation.
-  Stores an entry in the Organizer's memory or initiates an operation.
-  Stores an edited entry as new and leaves the original entry unchanged.

- ⊞ Activities the pop-up menu for a field displaying the “pop-up” symbol.
- ⬆⬇⬅➡ Moves the cursor.
- ⬆⬇ Displays any information not shown within an entry.

## Creating a New Entry

In Index or View mode, pressing **NEW** opens a blank form for creating a new entry.

Make the following new Tel entry:

CATEGORY	PERSONAL
LAST NAME	Jones
FIRST NAME	Pat
OFFICE#	201-555-6546
FAX#	201-555-6547
COMPANY	SHARP Corporation
TITLE	Supervisor

1. Press **APP** to open the application.
2. Press **NEW** on the keyboard.

A blank form opens in Edit mode.

3. Press **⬆** to move to the CATEGORY field . Press **⊞** to open the pop-up menu. Select PERSONAL.
4. Press **⬇** to move to the LAST NAME field and type in **Jones**.
5. Press **⬇** to move to the FIRST NAME field and type in **Pat**.
6. Press **⬇** to move to the OFFICE# field and type in **201-555-6546**.
7. Press **⬇** to move to the FAX# field and type in **201-555-6547**.
8. Press **⬇** to move to the COMPANY field and type in **SHARP Corporation**.
9. Press **⬇** to move to the TITLE field and type in **Supervisor**.
10. Press **ENTER** to store the entry.

The message “Stored!” appears briefly. The entry is now stored in the Organizer’s memory and displayed in View mode.





For other useful methods available in Edit mode, see right.

## Editing an Existing Entry

To edit an entry already stored in memory, you must first access the entry in Edit mode (in which it was originally created).

1. Press to open the application.
2. Select the desired entry in Index mode.
3. Press to open the entry in Edit mode.
4. Make any necessary changes.
5. Press to store the changes when you are finished.

The new, edited entry is now stored, replacing the original entry.

## Editing Techniques

This section explains all the general editing techniques used in Edit mode when making a new entry or editing an existing entry in all of the applications. (The Memo application has many additional features for working with text; see p.33 for more information.)

### Fields

Most applications divide the display into field boxes. The number of fields in each application varies, as do the types of fields. The different types of field include text fields, a date field, time fields and pop-up fields.

You can type any character into a text field. The size of a text field is limited only by the size of the entry. Text fields adjust their size automatically to accommodate the number of lines entered.

Only a date can be entered in a date field, usually in the format MM/DD/YYYY. For example, you would type **07232000** to enter July 23, 2000.

Only a time of day can be entered in the time field, in the format of HH:MM followed by or (for AM and PM). For example, to enter 9:00 AM, you would type **0900** then press .

When the pop-up symbol appears by a field while editing an entry, this indicates that a pop-up menu is available for the field. The pop-up menu contains a list of values available for the field, and is used by pressing and selecting the desired value from the pop-up list. Note that the pop-up symbol only

appears next to a field in Edit mode, when the field is selected. When you move out of a pop-up field, the pop-up symbol disappears.

### The cursor

The cursor is used to work with text, indicating the position where text will be entered or deleted. It is also used to select items from menus or lists.

In text fields, where there is no restriction on the type of text (letters or numbers) that can be entered, the cursor appears as **I**.

In the date and time fields, the cursor appears as **■**, indicating that numbers only should be entered in a specified format (see above).

 In text fields or boxes when there is no character at the cursor position, the cursor appears as **I**.

### Typing in text

Typing in text is simple and straightforward. The Organizer's keyboard layout is just like the keyboard on a typewriter or computer.

#### Letters (lower-case and upper-case)

Any of the standard letters (A to Z) can be entered by pressing the corresponding key. All letters will normally appear in lower case. Hold down either of the **⇧** keys while pressing letter key (s) to enter upper-case letters. **⇧** functions like a "Caps lock" key on a typewriter or computer. Once pressed, the symbol **Ⓢ** will appear at the upper right corner of the display.

Any letters typed while the Organizer is in CAPS mode will appear in upper case. To switch back to lower-case mode, simply press **⇧** again. To enter lower-case letters while in CAPS mode, hold down **⇧** while pressing a letter key.

### Numbers

Pressing the corresponding numeric keys enters numbers. Numbers are entered regardless of whether CAPS mode is on or off.







### Symbols

The symbols that appear in dark blue above certain keys can be entered directly from the keyboard. Holding down **⇧** while pressing the appropriate key will allow you to enter these symbols. Colons can be entered by holding down **⇧** and pressing the **⋅** key. In addition, a large number of special symbols are available by pressing **⇧** **⇩**. (see p.48)

### Moving around the Display

You can move the cursor around the display with the arrow keys **←** **→** **↑** **↓**, **↶** **↷**. In addition, you can hold any arrow key down for continuous rapid movement.

The following convenient keyboard shortcuts are also available in Edit mode:

	Moves the cursor to the end of the line.
	Moves the cursor to the beginning of the line.
	Moves the cursor to the first line of a field.
	Moves the cursor to the last line of a field.
	Moves the cursor to the first field.
	Moves the cursor to the last field.

## Deleting Text

If you make a mistake while entering text, use the following key to erase the incorrect text, then enter the correct text:

 Deletes the character before the cursor.

## Working with Blocks of Text



Working with a block of text is sometimes easier and more convenient than working with characters one by one. The first step is to select the text to work with.



1. Hold down the  key while using the arrow keys to move over the entire text that you want to work with. This will "highlight" the text (display it in reverse white on black).



TEL	
CATEGORY	BUSINESS
LAST NAME	JONES
FIRST NAME	Jones
COMPANY	SHARP Corporation
TITLE	Supervisor
OFFICE#	201-555-6546
FAX#	201-555-6547

2. You can now perform a number of operations on the selected text.

 Deletes the selected text





  Copies the selected text to the clipboard so that it can later be pasted to another location.

  Deletes the selected text from its current location and moves it to the clipboard.



  Replaces the selected text with whatever is currently in the clipboard.

 For a full explanation of the cut / copy / paste functions, see p.47.

## Scrolling the Display



If there is more information than can be displayed at one time,  or  will appear at the top right hand corner of the screen. Press  or  to scroll the information one line at a time.

## Finding Specific Entries in Your Organizer



There are a number of ways that you can locate entries and information in your Organizer. One is to scroll between entries using the  or  keys. Others are as follows.

## Using Index Mode

Index mode gives you a listing of all the entries in a particular application. It is useful for providing a summary list of the entries contained for that application, from which a desired entry may be selected.

1. Press  to enter the Main Menu Screen to select the application or press the desired application key directly.
2. If it is not already displayed, switch to Index mode by pressing .

A list of the existing entries appears.

3. If the desired entry is not displayed, you can scroll the list of entries by pressing  or .

TEL		<BUSINESS >	
Brown,Bill	201-496-8574	Swift Corporation	
Brown,Charlie	812-254-1813	Soap Corporation	
Curren,Tom	221-654-6544	SHARP Corporation	
Harris,Keith	212-555-5555	SHARP Corporation	
Jackson,Thomas	201-635-6657	SHARP Corporation	
Jones,Pat	201-555-6546	SHARP Corporation	

SEARCH	
Find all entries containing:	SECRET ONLY
[Pat]	[2nd]+[-]:
1 ALL	5 Tel
2 Schedule	6 Memo
3 Birthday/Ann	7 Expense
4 To Do	

- When the desired entry is displayed, select it and press **ENTER** to see the entry in full.
- The most relevant entry will be highlighted if you press any letters / symbols / numbers. Press **ENTER** to see the details of the entry. (Only available in Tel / Memo application).
- You can choose how items are arranged in an index by changing the index mode in INDEX ITEMS / INDEX BY within the application menu. (Only available in Tel / To Do / Memo applications).

- Enter the name you are looking for. For example, type **Pat**.
- Press **↓** or **↑** and select Tel and press **ENTER** to start searching.

 To search only secret entries (see p.58), press **2nd** **-** to check the SECRET ONLY item.

The Organizer will now display the first entry that contains the "keyword" that you entered.

### Using Keywords

If you know a particular entry is in your organizer, but you cannot remember where, you can use the Search command to find it.

- Press **MAIN** to enter the Main Menu Screen to select the application or press the desired application key directly.
- Press **2nd** and then press **S**.

The Search window will open.

TEL	
NAME	Pat, Jones
COMPANY	SHARP Corporation
TITLE	Super visor
OFFICE#	201-555-654
FAX#	201-555-654

SEARCH	
PREV/NEXT [A I V]	
CANCEL [ESC]	
DECIDE [ENTER]	

If there is more than one entry that contains the keyword, press **↓** until you find the entry you are looking for. Then press **ENTER** when you have finished searching.

### By Date

You can use the Calendar to quickly and easily find information related to a time and / or date.

## 20 | General Operation

1. Press **MAIN** to enter the Main Menu and select CALENDAR.

The Calendar of the current month appears. (If there is a dot besides a specific day, it indicates that there is a Schedule appointment; if a specific date is displayed in reverse, it means that there is a Birthday / ANN entry.)

MAY 2000	JUN 2000	JUL 2000
S M T W T F S	S M T W T F S	S M T W T F S
1 2 3 4 5 6	1 2 3	
7 8 9 10 11 12 13	4 5 6 7 8 9 10	2 3 4 5 6 7 8
14 15 16 17 18 19 20	11 12 13 14 15 16 17	9 10 11 12 13 14 15
21 22 23 24 25 26 27	18 19 20 21 22 23 24	16 17 18 19 20 21 22
28 29 30 31	25 26 27 28 29 30	23 24 25 26 27 28 29
	( 153-2 131 ) 30 31	

2. Select a day using the arrow keys, then press **ENTER** to view the Schedule, Birthday / Ann or To Do entries on the selected day.

APR 8, 2000	S M T W T F S
9: 00A~10: 00A	
10: 00A~11: 00A	Production meeting
11: 00A~12: 00P	
12: 00P~ 1: 00P	Schedule data 1
1: 00P~ 2: 00P	Schedule data 2
2: 00P~ 3: 00P	
3: 00P~ 4: 00P	

 For more information about using the Calendar application, see p.23.

 You can open the Calendar menu by pressing **MENU** to select the desired Calendar view.

## Deleting Entries

Entries in the Organizer can be deleted using either the **DEL** key or the application menu.

### Deleting single entries

1. Open the desired application.
2. Select the entry in Index mode or view mode.
3. Press **DEL** on the keyboard.

A confirmation message appears asking if you are sure you want to delete the selected entry.

4. Press **ENTER** (or **ESC** to cancel the deletion).

### Deleting entries using the application menu

You can also make deletions using the application menu. The DATA DELETION submenu allows you to do this flexibly and easily.

1. Open the desired application.
2. Select the entry in Index mode or display it in View mode.
3. Press **MENU** in the selected function to open the application menu.
4. Select DATA DELETION, then press **ENTER**.

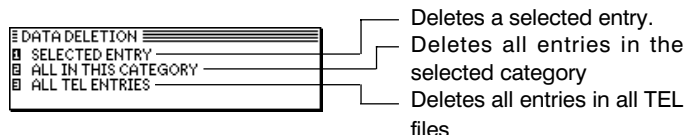

5. Select SELECTED ENTRY, then press **(ENTER)**.

A warning message appears asking if you are sure you want to delete the entry.

6. Press **(ENTER)** (or **(ESC)** to cancel the deletion).

## Checking the Time and Date

The current time and date are shown on the top of the Main Screen. Press **(MAIN)** to jump to the Main Menu screen directly.

1. Press **(MAIN)** twice to enter the Second Main Menu and select Clock to check the current date and time.

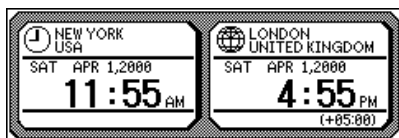

2. Press **(ESC)** or any other application key to close the Clock application.

 For a full explanation of the Clock application, see p.38.

## Checking the Memory

The Organizer has a certain memory capacity in which operations are carried out and data that has been entered, such as phone numbers and memos, are stored. When the amount of data already stored approaches the Organizer's maximum memory capacity, you may not be able to store an entry or the data being processed may be lost when you change applications. To avoid these problems, you should check the remaining memory space regularly and free up space when necessary by deleting out-of-date entries. The Check Memory function allows you to easily check the amount of free memory available in the Organizer, and thus avoid the inconvenience of running out of memory and losing data.

1. Press **(MAIN)** twice to enter the Second Main Menu.
2. Select Memory then press **(ENTER)**.

The display shows the summary of the Organizer's memory usage, availability and version number.

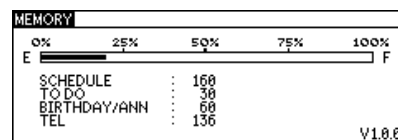

3. Press **(ESC)** to close the display.

 Even if the display shows a small amount of free memory available, that amount may be insufficient for certain

operations to work properly. You are strongly recommended to carry out regular “housekeeping” by deleting unwanted or out-of-date information to prevent the memory becoming full.

## The Second Main Menu - the Organizer’s Basic Utilities

Many of the basic utilities are accessed through the Second Main Menu. It is also used to set up and configure certain features, such as the display contrast.

Press **MAIN** twice to enter the Second Main Menu then press the number key to enter the respective application or move the cursor to select the application and press **ENTER**.

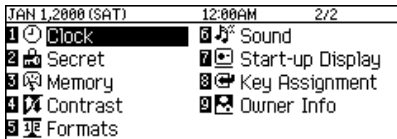

- 1** Clock- The unit’s built-in clock displays the correct time and date in your area.
- 2** Secret- Setting the password / locking the organizer (see p.56)
- 3** Memory- Checking the memory size (see p.21)

- 4** Contrast- Setting the display contrast (see p.10)
- 5** Formats- Setting the calendar display format and time system (see p.59)
- 6** Sound- Setting the key sound / daily alarm / schedule alarm on or off (see p.10)
- 7** Start-up display- Activating the autorun of basic application or choosing to show / hide the owner’s information (see p.55)
- 8** Key Assignment (see p.60)
- 9** Setting the Owner’s Information

The Owner Information comprises your name, address and telephone number. You can choose to have this information displayed each time you turn the Organizer on.

If you make a mistake while entering the Owner Information, don’t worry! You can edit the Owner Information easily during normal use.

1. Press **MAIN** twice to enter the Second Main Menu and select Start-up Display then press **ENTER**.
2. Press **↓** to move to the OWNER INFORMATION field. Press **←** / **→** to choose SHOW or HIDE the owner’s information.

# CHAPTER 3

## Time Management

The Organizer's Calendar, Schedule, To Do and Birthday / Ann (Anniversary) applications let you structure and manage your time easily, whether scheduling appointments or giving reminders about important people and events. The explanations and examples in this chapter will give you the information you need to make all of the time management features of these applications work for you on a daily basis.

### The Calendar Application

The Calendar represents the Organizer's most central utility. It serves as a calendar that you can reference at any time for the correct date, and also as a time management utility, indicating important dates so that you can keep track of your time and appointments. The application performs as a highly sophisticated calendar that can display details of any month from January 1901 to December 2099. The Calendar also provides you with a convenient way of accessing, viewing and making new entries in the Ann and Schedule applications.

The Calendar provides you several Calendar views: 3-Month View and Daily Calendar.

**3-Month Calendar:** The specified month is centered, and the previous and the next months are shown on the left and the right, respectively.

**Daily Calendar:** The specified day is shown.

You can use the Calendar menu to select a particular Calendar view directly, regardless of which view you are already using.

1. Press **MENU** to open the Calendar menu.
2. Select VIEW and press **ENTER**.
3. Select the desired view in the submenu and press **ENTER**.

#### Selecting a date

From any view, you can scroll to the previous or next time period (whether the next month or day) by pressing **▲** or **▼**, then moving the cursor to a specific date to select it for display in another Calendar view. However, another convenient way of selecting a date that is not on the display is using GO TO A SPECIFIC DATE in the Calendar application menu.

1. Press **MENU** in any Calendar view, and select GO TO A SPECIFIC DATE, then press **ENTER**.

A date entry window appears.

2. Enter the date you want to select in the order of month, day, and year. Single-digit months and days should be preceded by a "0".



## 24 | Time Management

3. Press **ENTER**.

The selected date will appear in the current Calendar view.

 You can select **GO TO TODAY** in Calendar menu to directly skip to today.

 You can select **DAILY** in **VIEW** menu to jump to today's Daily calendar.

### Date Calculating

You can find and display any date a given number of days before or after a particular date.

Example: View the calendar 60 days from today.

1. Enter into the 3-Month view.
2. Select **GO TO TODAY** in Calendar menu to skip directly to today.
3. Press **Q** **6** **0** **T** to specify the date 60 days in the future. The calendar for the corresponding month appears, with the appropriate date selected.

 Press **w** to specify a number of days in the past, **Q** for a number of days in the future.

### The Calendar application menu

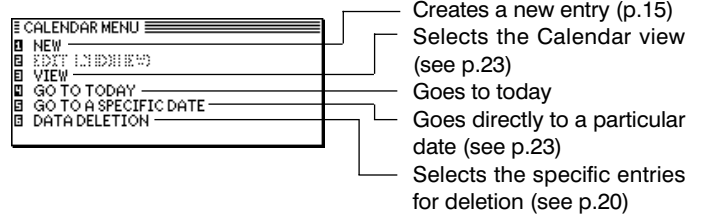

### The Schedule Application

The Schedule application allows you to enter appointments, times and dates for meetings, parties and events, and also to set an alarm to sound prior to or at the time of a scheduled entry. This makes it easy to organize your entire day and manage your appointments. Schedule entries are indicated on the Calendar's 3-Monthly view and Daily Calendar view.

#### Selecting a specific date

If you want to jump to a specific date to find entries or make a new entry, you can do it easily using the application menu.

1. In Index mode of the Schedule application, press **MENU**, and select **GO TO A SPECIFIC DATE**, then press **ENTER**.

A date entry window appears.

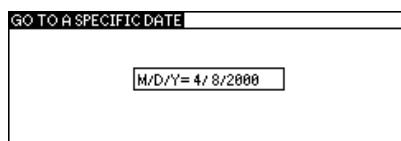

2. Enter the date you want to go to.
3. Press **ENTER**.

The first entry on that day is selected in Index mode.

If you would like to make a new entry, press **NEW** or press **MENU** and then select **NEW**, or if you would like to view other entries on that date, press **▲** or **▼**.

### Setting a Schedule alarm

A Schedule alarm can be set to remind you of scheduled events such as appointments and meetings. You can set an alarm for any entry that has a starting time set. Alarms that have been set will sound even if the unit is turned off.

Enter the following information with an alarm set for one hour in advance:

Date	July 16, 2000.
Time	1:00 - 2:00 pm
Description	Lunch with Sally

1. Press **MAIN** to enter the Main Menu and select Schedule or press **Q** to enter the application directly.

2. Open a new entry by pressing **NEW** or choosing **NEW** in the application menu.
3. Enter the Date and then move to the TIME field.
4. Enter the starting time and ending time, each followed by **P** (PM).

Move the cursor to the alarm time field. Alarm time will automatically be set 15 minutes before the schedule starting time.

5. Enter the desired alarm. Type **1200** and press **P** (PM).
6. Move to the DESCRIPTION field and type **Lunch with Sally**.
7. Press **ENTER**.

To set an alarm for any entry that has already been stored, display the entry in Edit mode and enter the desired alarm time in the alarm field.

### Clearing a set alarm

1. Press **MAIN** twice to enter the Second Main Menu.
2. Select Sound then press **ENTER**.
3. Move the cursor to choose OFF in SCHEDULE ALARM/ DAILY ALARM.

The Schedule application menu (in Daily View screen)

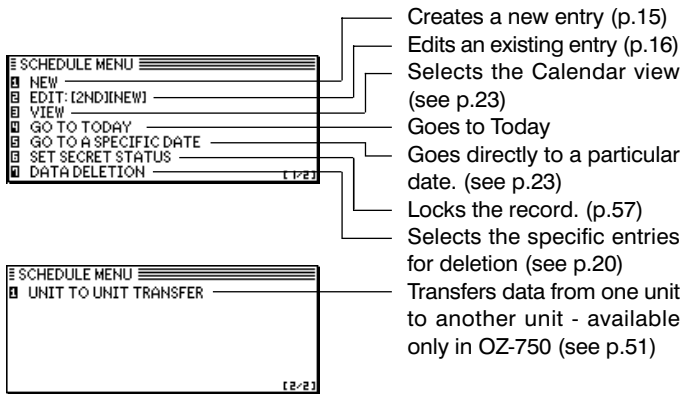

## The To Do application

The To Do application is a valuable organizational tool to help you meet deadlines and to add structure and efficiency to your work that you set for yourself. This application allows you to organize and track tasks and objectives and assign them priorities. To help you in this task, entries are identified as TO BE DONE or DONE.

### Making new entries

Entries in the To Do application contain five fields: Category, Description, Due Date, Priority, and DONE indicator. The category field, which you can define yourself and assign as you like, can be used to manage tasks according to project, the personnel involved in them, or any other groupings you wish to define.

### Assigning priority to entries

In the PRIORITY field you can enter a number (1-5) or letter N, which then indicates the importance of a task or project.

Enter the following information:

Description	Prepare market analysis of computers
Priority	1

1. Press **MAIN** to enter the Main Menu and select To Do.
2. Press **NEW** directly or press **MENU** and then select NEW.

The To Do entry display opens.

TO DO	
CATEGORY	PERSONAL
DESCRIPTION	
DUE DATE	M/D/Y= / / ( )
PRIORITY	1 2 3 4 5 N
DONE	<input type="checkbox"/> : [2nd][SPACE]

3. Enter the description of the entry. Type **Prepare market analysis of computers**.
4. Skip the DUE DATE field and move to the PRIORITY field.
5. Type **1**.

TO DO	
CATEGORY	PERSONAL
DESCRIPTION	Prepare market analysis of computers
DUE DATE	M/D/Y= / / ( )
PRIORITY	1 2 3 4 5 N
DONE	<input type="checkbox"/> : [2nd][SPACE]

6. Press **ENTER**.

The entry is now stored.

### Assigning due dates to entries

A To Do entry must be given a due date (or month) so the Organizer knows how to classify it and the Calendar knows when it becomes due. The due date can be entered either by typing in the actual date, or by selecting the date from the pop-up calendar and using the arrow keys to select the desired month and day.

Enter the following information:

Description            Sales report  
Due Date                June 20, 2000.

In the To Do application:

1. Press **NEW** directly or press **MENU** to select NEW in the application menu.
2. Type **Sales Report**.
3. Move to the DUE DATE field. Enter the due date in the order of the month, day, year. Type **06202000**, or press **SMBL**, use **▲** and **▼** to display June 2000, then use **▲** **▼** **◀** **▶** to move to the 20th of the month.
4. Press **ENTER**.

 At index view, a ! mark will be displayed beside an overdue entry (ie. an entry for which the due date has passed).

### Finding entries using Index mode

1. Go to Index mode.

TO DO (Done)		< * ALL * >
✓	Check the status of catalog	6/17
✓	Prepare forecast	6/17
✓ [2]	Send price	6/18
✓ [1]	Prepare market analysis of computers	6/19
✓ [3]	Sales report	6/19

## 28 | Time Management

There are two Index modes in the To Do application. One is TO BE DONE and the other is DONE. Select VIEW from the application menu to switch between TO BE DONE index mode or DONE index mode. Index mode in the To Do application can show entries based either on their priority level or their due date. In the default setting, entries are arranged in chronological order based on the due date. Select INDEX BY from the To Do application menu, then PRIORITY from the submenu to display entries based on priority. To display entries in chronological order based on due date, select INDEX BY from the menu, then DATE from the submenu. This means you can access entries in the way that is most convenient for you.

2. Press  $\Delta$  and  $\nabla$  to select the entry you want to review.
3. Press  $\text{ENTER}$  to see the entry in full.

The entry is displayed in View mode.

 If To Do application is assigned the application key, press the application key to change the TO BE DONE / DONE Index view.

### Checking off completed entries

Once you have reached a target you set for yourself, it is a good idea to check off the entry as completed so that you can concentrate on things still to be done.

This operation can be done in the To Do application, which lets you check off a task that you have completed before its due date.

Check off entries in the To Do application.

1. Select the entry in Index mode.

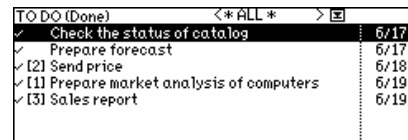



Task	Due Date
✓ Check the status of catalog	6/17
✓ Prepare forecast	6/17
✓ [2] Send price	6/18
✓ [1] Prepare market analysis of computers	6/19
✓ [3] Sales report	6/19

2. Press  $\text{2nd}$   $\text{SPACE}$ .

The entry is checked off and marked with  $\checkmark$ . The DUE DATE field name changes to DONE DATE and today's date appears in it. The checked off item is sent to DONE index.

3. Press  $\text{ENTER}$  to switch to One Data View.

 If you mistakenly check off an entry as completed, you can uncheck the entry by pressing  $\text{2nd}$   $\text{SPACE}$  again. However, if you do this, the entry will be stored without a due date.

 Once a project or task is completed, and you no longer need the To Do reminder, you can delete the entry, or groups of entries, which will free up memory in the Organizer.

### Updating the Category list

You may wish to edit the names of existing categories.

1. From the To Do application's Index view, press  $\text{MENU}$ .

2. Select CATEGORIES then press **ENTER**.

The CATEGORIES window appears.

3. Make the desired change to the category list.
4. Press **ENTER** to store the edited entry.

The To Do Index view appears.

 When you edit a category name, any To Do entries that refer to that category are automatically updated to reflect the change.

### Using the Index Mode

The To Do application allows you to define the way in which your entries are sorted in index view. You can select among DATE or PRIORITY.

1. From the To Do application's Index view, press **MENU** then select INDEX BY.
2. Move the cursor to select the index mode by DATE or PRIORITY then press **ENTER**. (In Index view, you can press **D** / **P** directly for Index by Date or Index by Priority respectively.)

The To Do application menu

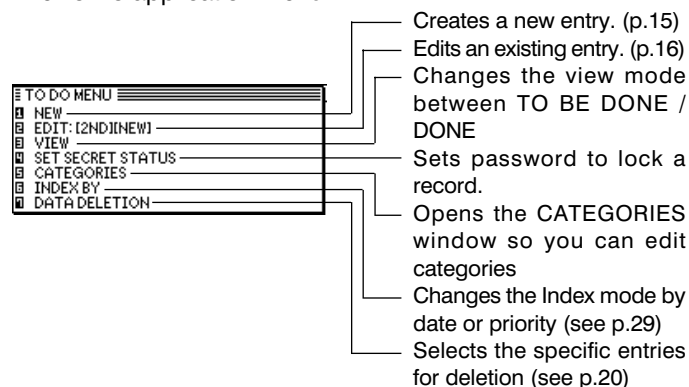

### The Birthday / Ann (Anniversary) Application

The Birthday / Ann (Anniversary) application makes it easy for you to keep track of annual events, such as wedding anniversaries and birthdays of friends, relatives and business associates. Once entered, the annual events are indicated by dates highlighted in white on black on the Calendar, giving you plenty of warning to prepare for them well in advance every year. You can access them by pressing **ENTER** after selecting the desired date.

The Birthday / Ann application menu

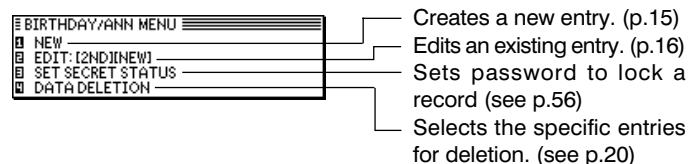



**CHAPTER 4****Creating Your Own Database**

This chapter describes using the Tel (Telephone). The flexibility of the application allows you to manage a wide range of information, from simple address book to an extensive restaurant guide or even a listing of your important business contacts.

## The Tel Application

The Tel application stores the names, telephone numbers, and addresses of business clients, companies, personal friends and so on.

 To make a new Tel entry, see page 15.

### Updating the Category list

You may wish to edit the names of existing categories.

1. From the TEL application's index view, press **(MENU)**.
2. Select CATEGORIES, then press **(ENTER)**.

The CATEGORIES window appears.

3. Make the desired change to the category list.
4. Press **(ENTER)** to store the edited entry.

The TEL Index view appears.

 When you edit a category name, any TEL entries that refer to that category are automatically updated to reflect the change.

### Changing the Index Items

You can specify either Name and Office# or Name and Home# to be displayed on the Index mode of the Tel application.

1. Press **(TEL)** directly or select TEL in the Main Menu to open the application.
2. Press **(MENU)**, select INDEX ITEMS, then press **(ENTER)**.

The INDEX ITEMS window opens.

The current setting is indicated by a tick.

3. Select the desired index item, then press **(ENTER)**.

Then Name and Office# or Name and Home# will be displayed on the Index mode of the Tel application.

You can also choose to index the name field by its First Name or Last Name in INDEX BY within the application menu.

### Modifying the Field Order

The Tel application also allows you to define the field order of each category. You can assign a kind of field order for each category. Two kinds of field order. "Personal" and "Business" are available for you to choose.



## 32 | Creating Your Own Database

1. Press **[TEL]** directly or select TEL in the Main Menu to open the application.
2. Press **[MENU]**, select FIELD ORDER, then press **[ENTER]**.

The FIELD ORDER window appears.

FIELD ORDER		
PERSONAL	BUSINESS	PERSONAL
BUSINESS	BUSINESS	PERSONAL
USER 3	BUSINESS	PERSONAL
USER 4	BUSINESS	PERSONAL
USER 5	BUSINESS	PERSONAL
USER 6	BUSINESS	PERSONAL
USER 7	BUSINESS	PERSONAL

3. Assign a kind of field order for each category.
4. Press **[ENTER]** when you have finished. (Or **[ESC]** cancel the changes)

 For the details of the Tel application, see p.13.

## The Tel application menu

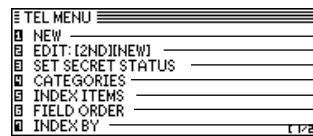

- Creates a new entry (see p.15)
- Edits an existing entry (see p.16)
- Sets password to lock a record (see p.56)
- Opens the CATEGORY window so you can edit or select category
- Selects the INDEX ITEMS according to the Home number or Office number
- Selects the FIELD ORDER assigned to PERSONAL or BUSINESS category.
- Selects the INDEX BY to change the index according to the FIRST NAME or LAST NAME.

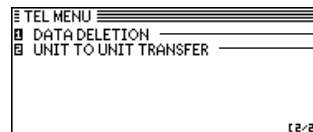

- Selects the specific entries for deletion (see p.20)
- Transfers data from one unit to other unit - available only in OZ-750 (see p.51)

## CHAPTER 5 Memo

This chapter explains the features of the Memo application, the Organizer's basic word processing utility. This application provides powerful word processing capability in a hand-held device.

### The Memo Application

The Organizer's Memo application provides you with a simple yet powerful means of recording information, from meeting notes to memorandums and letters.

Before reading this chapter, be sure you have read Editing Techniques in Chapter 2. More advanced editing features are used in this chapter. Be sure you have a good understanding of the Organizer's basic editing procedures before beginning to use the Memo application.

#### Creating documents

1. Press **MAIN** to enter the Main Menu and select Memo or press **MEMO** directly.

The Memo application opens in Index mode.

2. Press **NEW** directly or press **MENU** and select NEW in the application menu.

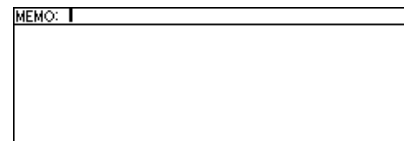

3. Type in the title **Letter to Frank**.
4. Press **ENTER**.
5. Type in the following letter (pressing **ENTER** to move to a new line):

*July 10, 2000  
Mr. Frank Smith  
Chairman  
ABC Co. Ltd.*

*Dear Mr. Smith:*

*Thank you for your fax of July 5th, 2000 regarding the Alpha Project.*

*We agree that it is too difficult to answer your questions about our new project properly based on the available information. We will receive the proper documentation within the next week.*

*This shouldn't cause any delay in our production schedules.*

*Sincerely,*

## 34 | Memo



It is not necessary to press  at the end of each line. The Organizer will automatically perform word wrapping onto the next line when the current line is full.

```
MEMO: Letter to Frank
Chairman
ABC Co. Ltd.
Dear Mr. Smith:
Thank you for your fax of July 5th, 2000 regarding the
Alpha Project.
```

6. Press  when you have finished entering the text.

The entry is then stored and displayed in View mode.

### Finding entries

Memo entries can be sorted for display in two ways: alphabetically according to their title, and by date of entry. You can choose whether to display the entries in date order or alphabetical order to make finding the desired entry as easy as possible.



If the alphabetical order is selected, type in a title is good idea for quick access to the data.

### The Memo application menu

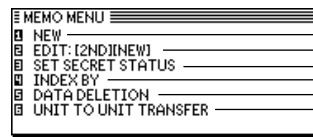

- Creates a new entry. (p.15)
- Edits an existing entry. (p.16)
- Sets password to lock a record (see p.56)
- Changes the Index mode by date or title (see p.34)
- Selects specific entries for deletion (see p.20)
- Transfers data from one unit to another unit - available only in OZ-750 (see p.51)

# CHAPTER 6

## Desk Accessories

The Organizer's desk accessories are a set of valuable utilities for everyday use. The Calc (Calculator) can perform calculations on figures entered using the number keys. The Clock can simultaneously display the day, date, and time in any two cities of your choice. This chapter provides all the information you need to enjoy full use of these very useful applications.

### The Calc (Calculator) Application

The Organizer provides a 12-digit calculator which performs mathematical operations. In addition, it has a powerful currency / units conversion function.

#### Using the arithmetic calculator

1. Press **MAIN** to enter the Main Menu and select CALC, then press **ENTER**.

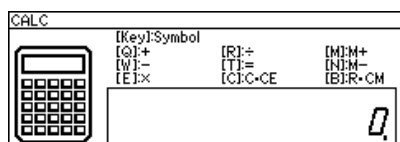

2. Perform the calculation using the numeric and mathematical symbol keys on the keyboard, just as you would with a regular electronic calculator.

To quit the Calc application, simply change to any other application by pressing the corresponding key.

To clear an entered value, press **C** once. To clear an entire calculator operation, press **C** twice.

Calculations are performed in the order of entry, not according to algebraic operator precedence, ie., the calculation  $8 + 2 \times 3$  is performed as:  $(8 + 2) \times 3$  not  $8 + (2 \times 3)$ . This is just as for a regular electronic calculator.

An M shown on the display indicates that a value is stored in the calculator's memory. Press **B** twice to clear the memory.

Press **-** to change the sign of a displayed value.

Press **DEL** to erase the last digit typed.

An E shown on the display indicates an error, usually an overflow error (when no more digits can be displayed). When this happens, the calculator will usually ignore any subsequent input until the error is cleared. press **C** to clear the error.

For further information on other calculator operations, see p.36.

#### When E appears

When any of the following situations occur, the error indicator E is displayed and calculations are suspended. Press **C** to clear the error.

## 36 | Desk Accessories

 The integer part of the calculation result is within the range of 13 to 24 digits (a rough calculation is obtained).

Example:  $4567890123 [x] 456 [=]$   
 $2.08295789608$  is displayed with E, which indicates that the rough result is :  
 $2.08295789608 \times 10^{12}$  (ie. **2,082,957,896,080**)

 The integer part of the calculation result exceeds 24 digits.

 The integer part of the numerical value in the memory exceeds 12 digits.

 A number is divided by "0".

### Calculation examples

Calculation	Example	Operation	Display (answer)
Arithmetic	$12 \times 3 + 5 =$	$12 [x] 3 [+ ] 5 [=]$	41.
Constant	$34 + 57 =$	$34 [+ ] 57 [=]$ The addend becomes a constant.	91.
	$45 + 57 =$	$45 [=]$	102.
	$68 \times 25 =$	(Subtraction and division are performed in the same manner.) $68 [x] 25 [=]$ The multiplicand becomes a constant.	1,700.
	$68 \times 40 =$	$40 [=]$	2,720.

Reciprocal	$1/8 =$	$8 [\div ] [=]$	0.125
Memory	Summation	↓ Clears the memory before performing any calculations. [R-CM] [R-CM] $25 \times 5 =$ $25 [x] 5 [M +]$ $-) 84 \div 3 =$ $84 [\div ] 3 [M -]$ $\pm) 68 + 17 =$ $68 [+ ] 17 [M +]$ (Total) = [R-CM]	$125.^M$ $28.^M$ $85.^M$ $182.^M$
	Temporary memory	[R-CM] [R-CM] $14 [M +] 3 [x] 2 [M -]$ $(14 - 3 \times 2) \times$ $(52 - 35) =$ $52 [-] 35 [x] [R-CM] [=]$	$6.^M$ $136.^M$

### Conversion function

The Organizer can be used to perform conversions between different currencies and units of length, area, volume, mass, temperature and energy. There are 4 conversion index groups. The first index group comprises 8 currency conversion screens in which you can set and edit the exchange rates yourself. The other 3 index groups have preset conversion factors so conversion can be performed right away.

#### Changing the currency rate

1. Press **MAIN** to enter the Main Menu and select Conversion.

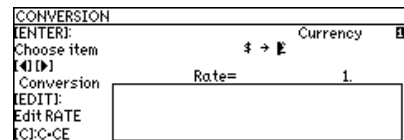

For example, you want to set one Canadian dollar equal to 0.45 pounds Sterling:

2. Press **2nd** **NEW** in order to change the rate.

The exchange rate line starts to blink.

- Press **C** to clear the original rate first. Then enter the rate 0.45.

 Make sure that a maximum of 10 digits can be entered.

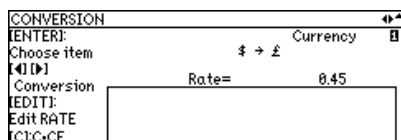

- Press **△** to move to the currency name field and then change what you want.  
Example: C\$ → STR£

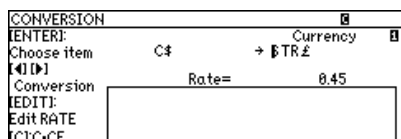

A maximum of seven characters can be entered on each side.

- Press **ENTER** when you have finished (or **FSC** to cancel the changes).

If you want to set another currency exchange rate, start again from step 2 above. You can use each currency conversion at any time once it has been set.

### Performing a conversion

For example, you want to find out how many liters there are in 10 gallons:

- Press **MAIN** to enter the Main Menu and select Conversion then press **ENTER**.  
(Press **ENTER** again to see conversion lists.)
- Press **△** and **▽** or **▲** and **▼** to move through seven conversion groups until you find the Volume units conversion.
- Select gal → l and then press **ENTER**.
- Enter 10 gallons and then press **D** to convert it.

The answer is displayed under the unit rate.

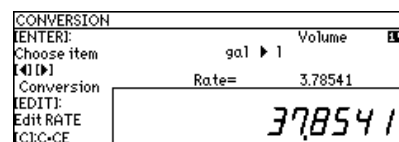

If you want to know how many gallons are equal to 10 litres, press **←** key to change from gal → l to gal ← l.

The method of converting currencies, units of length / area / mass / temperature / energy is the same as above.

 Press **⊖** to change the sign of a displayed value.

The following table shows the conversion factors that are preset in your Organizer.

CONVERSION	UNITS	FACTOR
Currencies	User-Specified	User-Specified
Length	inch-cm	2.54
	feet-m	0.3048
	yard-m	0.9144
	mile-km	1.609344
Area	acre-m <sup>2</sup>	4,046.86
	acre-ha	0.404686
Volume	gal-l	3.78541
	l.gal-l	4.54609
	fl.oz-ml	29.5735
	l.fl.oz-ml	28.4131
Mass	oz-g	28.3495
	lb-kg	0.45359237
Temperature	°F-°C	5/9(°F-32)
Energy	cal-J	4.18605
	hp-W	745.7
	PS-W	735.5

## The Clock Application

The unit's built-in clock makes it possible not only to know the correct time and date in your area, but also to know the time in other cities or any region around the world. The Clock is used as the reference time by the Calendar, Schedule, and To Do applications. In addition to these features, daylight saving time (DST) can be enabled for any city you designate, and for those countries that use an annual Daylight Saving Time adjustment.

As an aid to international business and travel, the Organizer is set to display the time in any other city you choose (called the World City) as well as your own city (the Local city).

To view the Clock, press **MAIN** twice to enter the Second Main Menu and select Clock, then press **ENTER**.



### Changing the Local city

The Local city is the city selected to provide the local time. When you first use your Organizer, the default Local city is set as New York. To change this setting:

1. Press **MENU** to open the Clock menu.
2. Select CHANGE LOCAL CITY, then press **ENTER**.

A list of cities appears. The currently selected city is at the top of the list. The cities are listed in alphabetical order by country and then by city name.



3. Type the first letter of the name of the country in which the target city is located. (For example, if you wanted to select San Francisco, you would type U for United States.) Then use and to display the city you want.
4. Use and or number to to select a city. You can also use and to move up and down the list.
5. If the selected city observes Daylight Saving Time, press to indicate this.

This advances the Local time by one hour. A symbol appears beside the city to indicate that daylight saving time has been set.

6. Press .

The Clock window appears, showing the new Local city. The time is automatically adjusted.

Certain countries will be abbreviated as follows:

Federal Republic of Germany	GERMANY, F.R.
Papua New Guinea	PAPUA N.GUINEA

Czech Republic	CZECH REP.
Republic of Trinidad and Tobago	TRINID. & TOB.
Dominican Republic	DOMINICAN REP.
French Polynesia	FR. POLYNESIA
United Arab Emirates	U.A. EMIRATES
United States of America	USA

Country and city names in the list and their relative time differences are current as of July 1997.

### Setting the time and date

1. Press to open the Clock menu.
2. Select ADJUST TIME / DATE and press .

The ADJUST TIME / DATE window opens.

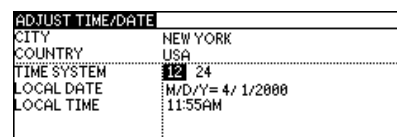

The window has three fields: Time System, Local Date, and Local Time.

3. Press or to indicate whether you want the time shown in 12- or 24-hour format.
4. Move to the LOCAL DATE field. Enter the current month and day in two digits, and the year in four digits. You can also select the date by pressing to display the pop-up



## 40 | Desk Accessories

calendar, then press **ENTER**. (Use **↑** or **↓** to display the desired month, then **←** **→** to move to the current day.)

You can set any date from January 1st, 1901 to December 31st, 2099.

5. Move to the LOCAL TIME field, enter the current time and press **A** or **P** (for AM or PM). Be sure to enter a 0 before a single-digit hour or minute entry.
6. Press **ENTER** (or **ESC**) to cancel the changes).

The time and date are now stored.

 Because the Organizer automatically adjusts the time after the Local city is changed, you should select the Local city before setting the time and date.

 Changing the setting in the TIME SYSTEM field also changes the time display format for all the Organizer's time-related applications and functions, such as Schedule.

### Checking the time in a city

You can find out the time anywhere in the world using the Clock application by selecting another city, called the World city. Selecting a city as the World city will display the time in that city as well as the Local city if you choose Clock in the Second Main Menu. The Organizer also shows you the time difference between the current World city and the Local city. When you first use the Organizer, the default World city is London.

### To change the World city:

1. Press **MENU** to open the Clock menu.
2. Select CHANGE WORLD CITY.

A list of five cities appears. These will be the six cities you most recently selected, or checked the time in. The currently selected World city appears at the top of the list.

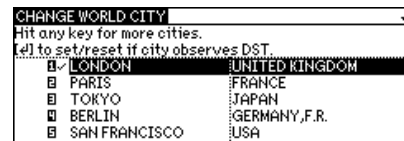

3. If the city you want to select as your World city is on the list, select it and then press proceed from step 6 below. If not, type the first letter of the country containing the target city.

A list of cities appears. Just as for the LOCAL CITY list, all cities in this list are in alphabetical order according to country name.

Use **↑**, **↓** to display the city you want.

4. Select the desired city.
5. If Daylight Saving Time (DST) is observed by the selected city, press **←** to indicate this.

A symbol appears beside the city, indicating that DST has been set.

6. Press **ENTER**.

The city is selected as the World city and the window closes.

The Clock window briefly appears, indicating the time in the selected World city. The time difference relative to the Local city is displayed below the World city time.

## Daylight Saving Time (DST)

### Assigning DST to a city

Designating Daylight Saving Time (DST) for a city automatically sets the time for that city one hour ahead of its regular time.

1. Press **MENU** to open the Clock menu.
2. Select either CHANGE LOCAL CITY or CHANGE WORLD CITY (it doesn't matter which you choose) then press **ENTER**.
3. Select the desired city using **▲**, **▼**, **▲** and **▼**.
4. Press **←→**.

A symbol appears to the left of the city, indicating that DST is in effect.

5. Press **ENTER**.

To de-assign a city's DST setting, simply follow the above procedure and press **←→** again (this toggles DST between on and off).

### Enabling and disabling DST

Once DST is assigned to a city, it remains in effect until it is de-assigned. Once a year, cities using DST will switch back to regular time. Rather than having to de-assign DST for each city separately, you can simply disable the Organizer's DST feature itself, which then applies to all cities within the Organizer. When these cities switch back to DST, you can simply re-enable the feature without having to change any city's entry.

1. Press **MENU** to open the Clock menu.
2. Select ENABLE DST and press **ENTER**.
3. The current DST setting (enabled or disabled) is indicated by a tick. Select ENABLE DST to change the setting.

When DST is disabled, the DST symbol disappears from the Clock display.

### Setting daily alarms

You can set alarms just like on a regular clock, separately from Schedule events, using the Clock menu. Set alarms will sound even if the Organizer is turned off.

This can be especially convenient, for example, when you need an alarm as a simple reminder, but do not want to make a full Schedule entry.

1. Press **MAIN** twice to enter the Second Main Menu and select Clock then press **ENTER**.
2. Press **MENU** to open the Clock Menu and select SET DAILY ALARM.

## 42 | Desk Accessories

The SET DAILY ALARM window opens. You can set up to five alarms.

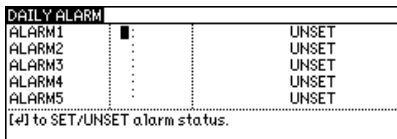

3. Enter the time for the desired alarm, followed by (A) or (P) for AM or PM.
4. Press (←) to set the alarm.
5. Move to the next field and set any other alarms you want using the same procedure.
6. Press (ENTER) (or (ESC) to cancel setting).

### Turning alarms on and off

To turn off an alarm that is sounding, press (ESC). Alarms will turn off automatically after sounding for 15 seconds.

To unset an alarm, select SET DAILY ALARM from the Clock Menu, select the alarm you want to turn off, and press (←).

### Disabling all alarms

Once you have set an alarm, it will sound at the appropriate time whether the Organizer is turned on or off.

There may be times when you do not want to hear any of the set alarms. You can disable all Daily alarms sound easily.

1. Press (MAIN) twice and select Sound, then press (ENTER).
2. Select DAILY ALARM in the SOUND menu.
3. Choose OFF, then press (ENTER).

### The Clock application menu

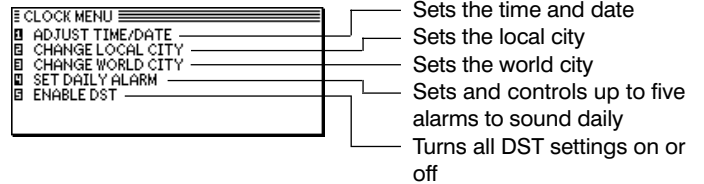

## CHAPTER 7 Expense

The Expense function is an easy way to track expense information for the traveling business person. Each record can contain the category, date, amount, payment type (AMEX, Visa, MasterCard, Diners Club, check, cash or two other types of your choice), status and a description of the expenses. In addition, the EXPENSE REPORT option allows you to see the total expenses for a single day or for a certain period.



### Entering Expense Record

1. Press **MAIN** to enter the Main Menu and select Expense, then press **ENTER**.

The Expense application opens in Index mode.

2. Press **NEW** directly or press **MENU** and select NEW in the application menu.

A blank form opens in Edit mode.

EXPENSE	
CATEGORY	PERSONAL
DATE	M/D/Y= 1/1/2000 (SAT) 
AMOUNT	0.00 
PAYMENT TYPE	AMEX
MEMO	
STATUS	TO BE SUBMITTED

3. Press **▲** to move to the Category field. Press **▣** to select the desired category. Press **1** - **7** to choose item.

Select PERSONAL

4. Enter the date in the order of month, day, year. Type in the date 06172000, or press **▣**, use **▲** and **▼** to display June 2000, then use **▲** **▼** **◀** **▶** and to move to 17th of the month.

EXPENSE		JUN 2000						
CATEGORY	PERSONAL	S	M	T	W	T	F	S
DATE	M/D/Y= 6/17/2000				1	2	3	
AMOUNT		4	5	6	7	8	9	10
PAYMENT TYPE	AMEX	11	12	13	14	15	16	17
MEMO		18	19	20	21	22	23	24
STATUS	TO BE SUBMITTED	25	26	27	28	29	30	

5. Press **▼** to move to the Amount field.

6. Type in the amount **100**.

 The expense amount can be up to 10 digits including up to two decimal places.

7. Move to the Payment Type field. Press **▣** to select the desired payment type. Press **1** - **7** to selected the desired item.

Select Visa.

8. Move to the Memo field and use the keyboard to input the description of the expense.

For example: Type in **Car rental at ABC RENTAL SERVICE**

## 44 | Expense

9. Move to the Status field. Press **⏏** to select the desired status mode. Press **1** - **4** to select.

Select TO BE SUBMITTED

EXPENSE		
CATEGORY	PERSONAL	
DATE	M/D/Y=6/17/2000 (SAT)	
AMOUNT		100.00
PAYMENT TYPE	Visa	
MEMO	Car rental at ABC RENTAL SERVICE	
STATUS	TO BE SUBMITTED	<b>⏏</b>

10. Press **⏏** to store the entry.

The message "Stored!" appears briefly. The entry is now stored and displayed in view mode.

EXPENSE			<* ALL * >	
CATEGORY	PERSONAL			
DATE	JUN 17, 2000 (SAT)			
AMOUNT		100.00		
PAYMENT TYPE	Visa			
MEMO	Car rental at ABC RENTAL SERVICE			
STATUS	TO BE SUBMITTED			

Press **⏏** or **ESC** to switch to Index mode.

EXPENSE			<* ALL * >	
JUN 17	100.00	Visa	T	Car rental at ABC
JUN 18	4,321.00	Cash	T	Debt
JUN 20	200.00	Cash	S	Train
JUN 22	1,143.00	AMEX	T	Chan Tao party

-  Simple calculations like addition, subtraction, multiplication, and division can be performed in the AMOUNT field by using the numerical and mathematical symbol keys on the keyboard. If an error occurs, you can clear the calculation by pressing **C**.

## Expense Report

A summary is a collection of records in the EXPENSE REPORT mode. Daily or Period expense summaries for entire records or for each payment type can be obtained.

-  Records marked as secret are not included in summaries if the SECRET function is on.

-  If an inappropriate date is entered (for example, an ending date which is earlier than the starting date), no calculation will be made, so be sure to enter the correct dates.

-  Select EXPENSE REPORT in Expense menu to jump to Expense Report function directly.

### Summarizing expense records for a specific date

To summarize all records in the BUSINESS category for AMEX on Aug 15, 2000, for example:

1. Press **MAIN** to enter the Main Menu and select Expense then press **⏏**.
2. Press **MENU** to open the Expense menu.
3. Select EXPENSE REPORT then press **⏏**.

A blank form is displayed.

EXPENSE REPORT	
CATEGORY	* ALL *
PERIOD (FROM)	M/D/Y= / / ( )
(TO)	M/D/Y= / / ( )
PAYMENT TYPE	* ALL *
STATUS	* ALL *
TOTAL:	

- Press **⏪** to select BUSINESS, then press **⏩**.
- Press **⏴** to move to the Period field. Enter the From date or the To date.

Type in **08152000**.

- Move to the Payment Type field. Press **⏪** to select AMEX.
- Move to the Status field and select TO BE SUBMITTED.
- Press **⏩** when you have finished. The day's AMEX expense total is displayed.

EXPENSE REPORT	
CATEGORY	BUSINESS
DATE	M/D/Y= 8/15/2000 (TUE)
PAYMENT TYPE	AMEX
STATUS	TO BE SUBMITTED
TOTAL: <b>78024.00</b>	

### Summarizing expense records for a certain period

For example, you want to find out the total amount of all expenses from July 14 to Aug 14, 2000:

- Press **⏪** to enter the Main Menu and select Expense

then press **⏩**.

- Press **⏪** to open the Expense menu.
- Select EXPENSE REPORT then press **⏩**.

A blank form is displayed.

- Select ALL.
- Press **⏴** to move to the Period field. Enter the From and To date.

Type in **07142000** and **08142000** respectively.

- Move to the Payment Type field and select ALL.
- Move to the Status field and select ALL.
- Press **⏩** when you have finished. The total expense amount for the specified period is calculated and displayed.

EXPENSE REPORT	
CATEGORY	* ALL *
PERIOD (FROM)	M/D/Y= 7/14/2000 (FRI)
(TO)	M/D/Y= 8/14/2000 (MON)
PAYMENT TYPE	* ALL *
STATUS	* ALL *
TOTAL: <b>67890.12</b>	

### Entering and changing category and payment type settings

In the CATEGORIES and PAYMENT TYPE reference lists, there

## 46 | Expense

are 12 types of categories and 8 types of payments. You can change the order of these existing categories and payment types or use another name or enter some new names.

1. Press **(MAIN)** to enter the Main Menu and select Expense then press **(ENTER)**.
2. Press **(MENU)** to open the Expense menu.
3. Select CATEGORIES or PAYMENT TYPE and then press **(ENTER)**.
4. Make any changes as you like.
5. Press **(ENTER)** to save the changes (or **(ESC)** to cancel the changes).

### Expense application menu

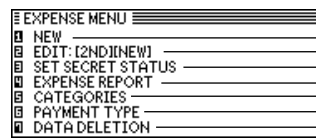

- Creates a new entry (see p.43)
- Edits an existing entry (see p.16)
- Sets password to lock a record
- Selects the Expense Report function (see above)
- Opens the CATEGORIES window so you can edit the category (see above)
- Opens the PAYMENT TYPE window so you can edit the payment type (see above)
- Selects specific entries for deletion (see p.20)

## CHAPTER 8

# Features and Utilities for Added Power

In addition to its basic functions, the Organizer also provides a wide range of utilities and features to give you even greater control over your information. This chapter introduces and describes these features, which include text cutting, copying, pasting and many more. Most people will not need to use all of these features on a daily basis. You can pick and choose from among them to find the features that best suit your current task and your own way of working.

In general, Schedule, To Do, Birthday / Ann, Expense, Tel, Memo applications share the features explained in this chapter, while exceptions are clearly noted.

### Copying or Moving Blocks of Text

The Organizer lets you cut, copy or paste blocks of text using the keyboard. The first step in cutting, copying, and pasting is to select the block of text you want to work with.

Text that has been cut or copied is stored on the unit's internal clipboard. Only one block of text can be stored in the clipboard at a time, and it will remain there until a new block of text is cut or copied. There is no limit to the number of times you can paste the same text from the clipboard.

1. Select an entry in its application's Index mode then display it in Edit mode.

2. Make sure the cursor is placed at the start of the text you want to select.
3. Hold  $\left[ \rightarrow \right]$  down while moving the cursor across the desired text to select it.
4. Press  $\left[ \text{2nd} \right] \left[ \text{X} \right]$  to move the selected text to a new location (i.e. remove it from its original location).

Press  $\left[ \text{2nd} \right] \left[ \text{C} \right]$  if you want to make a copy of the text (and leave the original text unchanged).

The selected text is stored in the clipboard.

5. Press  $\left[ \text{ENTER} \right]$  if you want to store the original entry with any changes you have made (including moving or copying the selected text), or press  $\left[ \text{ESC} \right]$  to discard all the changes you have made to the original entry. Note that even if you press  $\left[ \text{ESC} \right]$ , the text you selected will remain in the clipboard for you to use.
6. Open an entry, in Edit mode, in which you want to place the text.
7. Place the cursor at the start of the text you want to paste.
8. Press  $\left[ \text{2nd} \right] \left[ \text{V} \right]$ .

The text you selected is now pasted into the new location.

9. Press  $\left[ \text{ENTER} \right]$  to store the amended entry with the pasted text.



 By highlighting some text before pressing  $\text{2nd}$   $\text{PASTE}$  ( $\text{V}$ ), it can be replaced with the pasted text. Thus you can easily replace one block of text with another by highlighting it before pasting.

## Copying or Moving Entries

The CUT / COPY / PASTE operations provide a quick, convenient way for you to copy or move an entire entry to another location. Entries have to be in the same file and same application.

1. Select an entry that you want to copy or move in index mode.
2. Press  $\text{2nd}$   $\text{COPY}$  ( $\text{C}$ ).
3. Press  $\text{NEW}$  or select NEW in the application menu.
4. Press  $\text{2nd}$   $\text{PASTE}$  ( $\text{V}$ ).
5. Make any necessary changes to the duplicated entry. Press  $\text{ENTER}$  to store the entry when you have finished.

## Special Characters

The Organizer has a list of symbols, such as “ ` ” and “ | ”. These symbols and accented characters can be easily accessed and inserted into an entry. Select any of these special characters and insert it at the cursor's current location.

1. When entering data or editing an entry in any application in Edit mode, position the cursor where you want to insert a symbol or special character.
2. Press  $\text{2nd}$   $\text{SYM}$  on the keyboard.

The Symbol window appears.

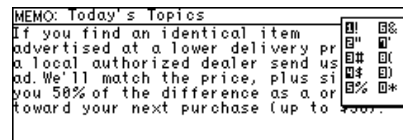















3. Press  $\uparrow$  or  $\downarrow$  until you see the character you want to enter.
4. Press the corresponding numeric key “0” - “9” to enter the selected symbol.

The symbol window closes and the selected character is entered at the current cursor position.

5. If the symbol you just selected is an accent mark (˘, ˆ, ˇ, ˘ or ˘), type the letter for which you want that accent mark to be used.

 When you next open the Symbol menu, the character you selected will be selected again as the default. The Organizer automatically displays the ten characters most recently selected from the Symbol menu in its first page, making it easy to quickly access characters that you use frequently.

 You can use the following keyboard shortcuts:

	keyboard shortcut	
~	 	} followed by the desired letter
`	 	
^	 	
..	 	
^	 	
Ç	 	
ß	 	



## CHAPTER 9



# Data Transfer

Your Organizer is a powerful pocketsize computer with built-in functions that make it possible to accomplish a broad range of tasks. It has the flexibility to connect to other Organizers and transfer data to desktop computers using data transfer facilities, which are accessed through the application menu. This chapter provides descriptions and examples to get you up and running quickly with these powerful features.

### Transferring Data

There are several ways to transfer information - whether specific entries or entire files - between OZ-750 and other information processing devices, including personal computers. In this way, you can back up your information to guard against losing it, or copy information so that you or someone else can work with it on another device. A summary of transfer devices, transferable data, and tasks to which a transfer device is most suited is provided in the table below.



Transfer device	Transferable data and direction of transfer (→: sent from OZ-750 ←: received in OZ-750)	Peripherals required	Most suitable task
Another OZ-750 Organizers	Single entries, entire files/applications → ←	IrDA transfer	Exchanging data with other OZ-750 Organizers.
Personal computer (see p.52)	→ ←	Docking Module	PC synchronization

-  Only OZ-750 has the function of infrared transfer.
-  Depending upon the SHARP or third-party software you are using, some features and capabilities may vary.
-  The Auto power off function (see p.10) is disabled in all transfer modes.

### Transferring between two OZ-750 Organizers

Data can be transferred directly between two OZ-750 Organizers via the infrared port. Single entries or all the entries in an application can be transferred in the Schedule, Memo and Tel applications.

The transfer procedure differs according to whether single entries or complete files are to be transferred.

-  Press **⓪** at any time to interrupt and cancel a transfer.
-  After a transfer, the display returns to the application being used before the transfer procedure has begun.

### Transfer single entries

Single entries can be transferred in TEL, SCHEDULE and MEMO.

1. Turn on both Organizers.
2. On the sending Organizer, select the entry you want to send.
3. On the receiving Organizer, press **MENU** to open the application menu and select UNIT TO UNIT TRANSFER then press **ENTER**.

A submenu opens.

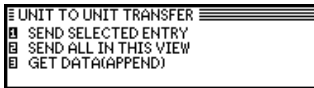

4. Select GET DATA (APPEND) then press **ENTER**.
5. On the sending Organizer, open the application menu and select UNIT TO UNIT TRANSFER then press **ENTER**. Select SEND SELECTED ENTRY then press **ENTER**.

The selected entry is transferred and appended to data in the appropriate application.

### Transferring all entries in an application.

All entries in Schedule, Memo and Tel can be transferred.

1. Turn on both Organizers.

2. Open the same application on each Organizer.
3. On the receiving Organizer, press **MENU** to open the application menu and select UNIT TO UNIT TRANSFER then press **ENTER**.
4. Select GET DATA (APPEND) then press **ENTER**.
5. On the sending Organizer, press **MENU** to open the application menu and select UNIT TO UNIT TRANSFER then press **ENTER**.

A submenu opens.

6. Select SEND ALL IN THIS VIEW.

All entries in the application are transferred. ("SEND ALL IN THIS VIEW" does not appear in the Schedule application.)

## Exchanging Information with a Personal Computer

Using included Organizer Link software (Day-Timer Organizer® SHARP Edition) and cable (Docking Module), you can exchange data with a personal computer. This makes it possible, for example, to use the unit when outside your home or office, then later transfer the data you have entered on the Organizer to your desktop computer.

### To setup the Organizer for use with the Organizer Link:

1. Make sure the unit is turned off.
2. Plug the Docking Module into the jack on the Organizer and into the PC's serial port (e.g. COM1). See the "Quick Start Guide" for details.
3. Turn on the Organizer, press **2nd** **MEM** to activate the PC SYNC (PC LINK) mode.



Your Organizer is now ready to transfer data. Consult the Day-Timer Organizer® SHARP Edition HELP file regarding subsequent transfer procedures.

Press **Q** at any time to exit the PC-Link mode. If you leave the Organizer in PC Link mode, more power is consumed from the batteries than usual, and the auto power off function does not work.

To conserve battery power, always press **Q** to leave the PC Link mode as soon as you have finished transferring data.



## CHAPTER 10 Personalizing Your Organizer

Now that you have an understanding of all of the Organizer's functions and its operation, let's take a look at the various ways you can customize the Organizer to suit your personal preferences: entries can be made secure through password protection and by marking them as secret; and a large font view can be selected for the Organizer's display.

The Organizer offers a level of security for its entries and operations. It is to define particular entries within various applications as secret, and then enable the LOCK ORGANIZER option in the Second Main Menu.

### The Start-Up Display

You can choose to have a program run whenever the Organizer is turned on, using the AUTORUN feature. You can also choose to show or hide owner information when you power on the Organizer.

1. Press **MAIN** twice to enter the Second Main Menu.
2. Select Start-up Display then press **ENTER**.
3. In the AUTORUN field, you can choose ON and press **ENTER** to activate the autorun first.

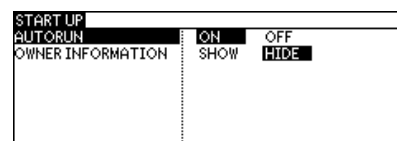

4. Press **My Programs** then press **MENU**. Select AUTORUN in MY PROGRAMS MENU and press **ENTER**.
5. Select the program for autorun by pressing the number or **ENTER**. A Checkmark is then added to the selected program which will run automatically each time the Organizer is turned on.
6. Select Start-up Display in the Second Main Menu then press **ENTER**. In the START UP menu, press **↓** to move to OWNER INFORMATION and press **←** **→** to select SHOW or HIDE the information once the Organizer is turned on then press **ENTER** to confirm.

### Setting the Owner's Information

The Owner's Information comprises your name, address and telephone number.

1. Press **MAIN** twice to enter the Second Main Menu.
2. Select Owner Info, then press **ENTER**.

The cursor starts in the NAME field.



## 56 | Personalizing Your Organizer

3. Enter your name, then press .

The cursor moves to the telephone number field.

4. Enter your telephone number, then press .

The cursor moves to the address field.

5. Enter your full address.

 Press  to move the start of the next line.

6. Press  when done.

A message appears confirming the Owner Information has now been set.



## Locking the Organizer

The Organizer's LOCK function allows you to keep selected information in your Organizer secure by locking it with a password that you specify. Entries that you have marked as secret cannot be accessed until the Organizer is unlocked using the Password. Individual entries can be marked as secret, so that only someone who knows the password can access them by unlocking the Organizer. Marking entries as secret has no effect until the Organizer is locked.

After registering a password, you will be prompted to enter that password upon start-up. The Organizer cannot be used if the password is not entered correctly. This is an important

security feature for users whose Organizers contain sensitive information.

### Turning on the LOCK

1. Press  twice to enter the Second Main Menu, select Secret then press .

The SECRET submenu appears.

2. Select LOCK ORGANIZER, then press .

The LOCK ORGANIZER window appears prompting you to enter a password.

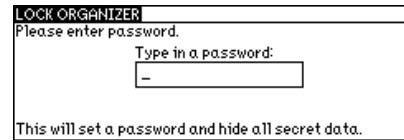

3. Enter any password up to sixteen characters long then press . Letters and numbers can all be used. This text box is case-sensitive which means that upper-and lower-case letters are treated differently. The password "SHARP", for example, is different from the passwords "Sharp" or "sharp".

 Choose your password carefully. If you forget your password, there is no way to bypass the Secret function or enter a new password without losing all data marked as Secret. It is strongly recommended that you use a password that you will always be able to remember, but which other people will be unable to guess.

4. Re-type the password to confirm and then press **ENTER** to store the password (or **ESC** to cancel the operation).

All entries marked as secret throughout the Organizer will then be hidden and will not be accessible until the Organizer is unlocked by giving the correct password.

A message appears warning you not to forget the password. If you have any doubt about whether or not you will always be able to recall this password, write it down and keep it in a safe place.

5. Press **ENTER**.

 appears on the top right corner indicating that any information you mark as secret will now be hidden.

### Marking / unmarking entries as Secret

You can mark or unmark any entry as secret in Edit mode.

1. Open the application containing the entry you want to mark as secret.
2. Display the entry in Edit mode.
3. Press **MENU** to open the application menu. Select SET SECRET STATUS and press **ENTER**.

“\*” symbol appears on the top right corner.

 If the Organizer has been locked (which hides all secret entries), an entry which has just been marked as secret will be hidden together with all other secret entries (for

more information, see the next section).

### Accessing Secret entries

Entries marked as secret are not shown in any of the Organizer's display modes when it is locked, and cannot be accessed using any of the search methods. To be able to recall and access secret entries, the Organizer must first be unlocked.

1. Press **MAIN** twice to enter the Second Main Menu, select Secret then press **ENTER**.

The Secret submenu appears.

2. Select LOCK ORGANIZER then press **ENTER**.

A window appears, prompting you to enter your password.

3. Enter your password exactly as you registered it.
4. Press **ENTER**.

If the password is correct,  disappears.

If the password is incorrect, a message appears indicating this.

5. After unlocking the Organizer, access any entry you want using the normal procedures.

If you forget your password, you will not be able to unlock the Organizer and access your secret information. If this happens, you will have to delete the old password to be able to continue to use the Secret function. This will also delete all entries marked as

## 58 | Personalizing Your Organizer

secret. For a full explanation of what to do if this occurs, see below, p.56.



You can press **2nd** **SEARCH** **S** and then press **2nd** **-** to find only those entries marked as secret once the Organizer is unlocked (see p.19).

### Automatic Relocking

Once a password has been registered, even if you unlock the Organizer using the procedure above, the Organizer will automatically lock itself each time you turn it off. This automatic relock feature protects your secret data in case you forget to relock the Organizer. The feature remains in effect as long as a password is registered. To disable this feature, the password must be deleted once the Organizer is unlocked.

You can also lock the Organizer yourself at any time:

1. Press **MAIN** twice to enter the Second Main Menu.
2. Select Secret then press **ENTER**.

The SECRET submenu appears.

3. Select LOCK ORGANIZER and press **ENTER**.

 appears at the top right corner indicating that the Organizer is now locked.

### Changing or deleting the password

To register a new password, the current one must first be deleted.

1. Press **MAIN** twice to enter the Second Main Menu.
2. Select Secret then press **ENTER**.

The SECRET submenu appears.

3. Select DELETE PASSWORD then press **ENTER**.



4. Enter your password exactly as you registered it.
5. Press **ENTER**.

A message appears indicating that the Organizer is unlocked. Entries that were marked as secret can be accessed until a new password is registered (to register a new password, use the procedure for Registering a password on p.56).

### If you forget your password...

If you have forgotten your password, the only way you will be able to delete it and continue to use the Secret function is to delete all entries marked as secret.

1. Press **MAIN** twice to enter the Second Main Menu.
2. Select Secret then press **ENTER**.

The Secret submenu appears.

3. Select DELETE ALL SECRET DATA and press **ENTER**.

A warning message appears asking if you are sure you want to delete all the secret entries. If you have forgotten your password, you have no choice but to proceed.

4. Press **ENTER** to delete all secret entries. This will then allow you to enter a new password.

## Changing the Calendar Display Format

The Organizer lets you change the default Calendar display to one you find more convenient. There are two aspects to changing the display: setting the weekly format and setting up the date format. You can use these options to set up a way of working that you prefer.

### Setting up the weekly format

You can set the Three-month view in the Calendar application to show the weeks in either a Sunday-to Saturday format (this is the default) or Monday-to Sunday format.

In the Calendar application:

1. Press **MAIN** twice to enter the Second Main Menu.
2. Select Formats then press **ENTER**.

A submenu appears.

3. In WEEKLY FORMAT, press **←** / **→** to select SUNDAY or

MONDAY, then press **ENTER**.

The Three-month view and daily view are then displayed accordingly.

### Setting up the date format

Almost all Organizer applications require a date to be entered at some point. The default format for date entry is "MM/DD/YYYY", where MM is the two-digit month, DD is the two-digit day of the month and YYYY is the four-digit year. The date will be displayed as "MMM DD,YYYY", where MMM is the three-character abbreviation for the month name. However, you can choose instead to have the date entered in the format "DD.MM.YYYY", which will then be displayed in the format "DD MMM YYYY".

For example, in MM/DD/YYYY format, the date July 4th, 2000 will be entered as "07042000" and displayed as "JUL 4, 2000". However in DD.MM.YYYY format, the same date will be entered as "04072000" and displayed as "4 JUL 2000".

1. Press **MAIN** twice to enter the Second Main Menu.
2. Select Formats then press **ENTER**.

A submenu appears.

3. In DATE FORMAT, press **←** and **→** to select the desired format, then press **ENTER**.

### Setting the time system

You can choose the time system to be displayed in 12- or 24-hour display format.

## 60 | Personalizing Your Organizer

1. Press **MAIN** twice to enter the Second Main Menu.
2. Select Formats then press **ENTER**.

A submenu appears.

3. In TIME SYSTEM, press **1** and **D** to select 12 (the default) or 24, then press **ENTER**.

### Assigning Keys for short-cut entry

You can assign 3 function keys to specific applications to facilitate easier and faster access to assigned applications. Any applications in First Main Menu and My Programs can be assigned in addition to the Clock function in the Second Main Menu.

1. Highlight the application that want to assign a key to e.g. Calendar.
2. To set the key assignment, open the application menu of Main Menu or My Programs.
3. Select ASSIGN TO KEY then press **ENTER**. The current key assignments are displayed.

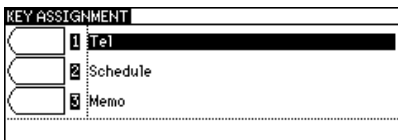

4. Press the number or move the cursor and press **ENTER** to assign the application on the selected key e.g. press **1**, Calendar is assigned to KEY 1.
5. A message showing that the buttons are successfully set appears on the screen.

 When you select Key Assignment in the Second Main Menu, the current key assigned can be seen. Press **2nd D** to reset the keys to their default.

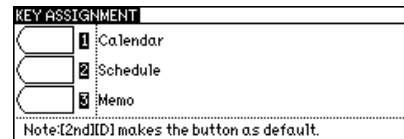

### Selecting the Large Font View



Since the Organizer's display is fairly small, you may find the displayed information easier to read if it is changed into a large font view.

In general, all of the Organizer's applications (except Clock, Calc, Calendar, Expense Report applications) share this feature. If you want to change the screen to be a larger font view, just press **2nd E** key on the keyboard. If you want to resume it, press **2nd E** again.

## CHAPTER 11

## How to use the Add-on

Add-on software programs add functionality to your Organizer. They are specially designed for your Organizer, named My Programs.

 Once installed, you can access and run these programs from the My Programs screen. To display the My Programs screen, press .

 You cannot run PC software on your Organizer.

 Using the AUTORUN feature, you can run an add-on program when the Organizer is turned on.



### Installing My Programs application

Additional software for your Organizer can be found on the included Software CD-ROM, as well as on the internet (SHARP's homepage).









1. Connect Docking Module to Organizer and PC.
2. Insert the included CD. If using Windows 95 / 98 or Windows NT the CD should start automatically. If not, double click the My computer icon on your PC, click your CD-ROM drive then navigate to Customize folder.

3. Click the [Customize] button and double click the file you want to install.
4. Follow the on-screen instructions.

### Using the program

1. Press  to view list of installed programs.
2. Launch the application by pressing the  -  key that corresponds to the application.

### Deleting a selected My program

1. Press  to view list of installed programs.
2. Use , ,  and  key to select the application to remove.
3. Press  to open the application menu.
4. Select DELETE SELECTED MY PROGRAM.
5. Press  to confirm (or  to abort).

The selected program is deleted from My Programs application.

## Setting a My Programs application to Autorun

My programs application can be automatically loaded and started when you press **Ⓢ**. Before an autorun is set, you must activate it first in Start-up Display.

1. Press **MAIN** twice to enter the Second Main Menu.
2. Select Start-up Display then press **ENTER**.
3. In AUTORUN field, select ON then press **ENTER**.

Once the autorun is activated, you can then choose the application for autorun.

1. Press **My Programs** then press **MENU**. Select AUTORUN in MY PROGRAMS MENU and press **ENTER**.
2. Use **▲** **▼** **◀** and **▶** to select application then press **ENTER**.
3. A checkmark is added to the chosen application.

When you press **Ⓢ** next time, the chosen application will automatically start.

### My Programs application menu

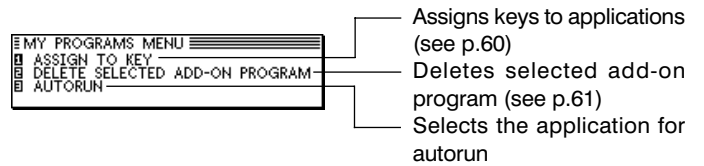



## Appendices

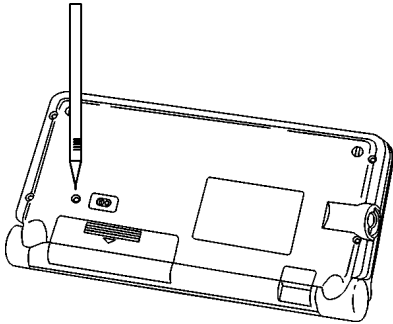

### A. Resetting the Organizer

A strong impact, exposure to an electrical field, or other unusual conditions may render the unit inoperative, and pressing the keys will have no effect. If this occurs, you will have to press the RESET switch at the bottom of the unit using a pen or similar object to be able to continue to use the unit.



 A condition that makes the unit inoperative may erase some or all of the data stored in memory.

 Do not use anything breakable, anything with a sharp tip or anything that might break to press the RESET switch.

 In case that the Organizer does not work properly after reset, you can remove the batteries and insert the batteries several seconds later. Then press  to open the Organizer.

#### All reset operation

If the unit still fails to function after it has been reset using the procedure above, you will have to reset it using a slightly more complicated procedure:

1. While pressing and holding , press and release the RESET switch.

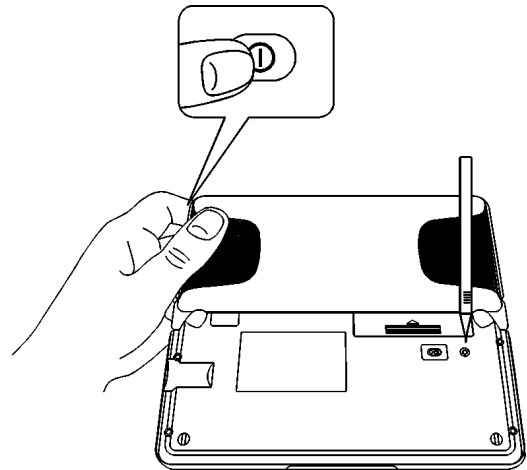

A message appears.



2. Release **Ⓛ**.

3. Press **ESC**.

The built-in clock is reset.

 Do not press **ENTER** in step 3. Doing so will delete all data in the unit.

## B. Battery Replacement

### General guidelines

The Organizer uses the following types of batteries:

Use	Type	Size / Model	Qty.
General operation	Alkaline batteries	LR6 (size "AA")	2

There are some extremely important points to remember when installing new batteries:

 Replace the two operating batteries at the same time with new batteries of the same type.

#### Caution:

 Keep batteries out of the reach of children.

 Remove batteries from the unit when they become weak or when the unit will not be used for a long period of time. Leaving weak batteries in the unit may cause battery leakage and damage from corrosion.

 Do not dispose of batteries by fire as they may explode.

### Replacing the operating batteries

The Organizer detects two low battery levels which are warning and fatal. When the batteries are in warning level, alert message appears on the screen. In fatal level, the Organizer will turn off automatically without indication.

If the alert message is shown, replace the batteries immediately.

1. Turn off the Organizer.
2. Set the battery replacement switch on the bottom of the Organizer to REPLACE BATTERIES (a red dot will appear).
3. Slide off the operating batteries cover.

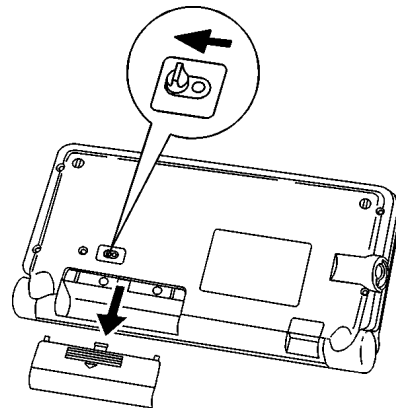

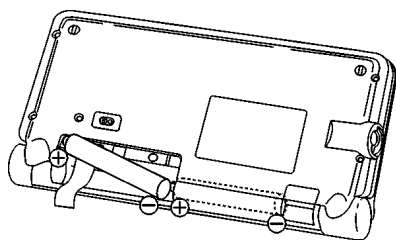

4. Remove the old batteries by pulling the ribbon tab.
5. Insert the two new batteries on top of the ribbon tab, taking care to position them correctly according to the plus (+) and minus (-) terminals, as shown below.



6. Replace the cover.
7. Set the battery replacement switch to NORMAL OPERATION.
8. Turn on the Organizer and set the clock. (see p.38)

If nothing happens when you press **Ⓚ**:

 Setting the battery replacement switch to REPLACE BATTERIES shuts off power to the unit. Check that the battery replacement switch is set to NORMAL OPERATION.

 Repeat the above battery replacement procedure step by step.

## C. Specifications

Model	OZ-730 / OZ-750
Display	239 x 80 dot matrix liquid crystal display

### Electronic unit section

Applications Calendar, Schedule, To Do, Birthday / Anniversary, Telephone, Memo, Expense, Expense Report, Clock, Calculation, Conversion, Add-on

Memory capacity	OZ-730:	1.5MB Flash memory User area approx. 896KB for data storage, 320KB for Add-on programs.
	OZ-750:	2.5MB Flash memory User area approx. 1,920KB for data storage, 320KB for Add-on programs.

Application capacity	OZ-730:	9,000 entries (Schedule 2,500, Tel 2,500, Memo 2,500, ToDo 1,000, Expense 500) in total
	OZ-750:	20,000 entries (Schedule 5,000, Tel 5,000, Memo 5,000, ToDo 3,000,

Expense 2,000) in total  
 These capacities assume the following  
 average entry sizes.

Schedule: 22 characters/entry  
 Tel: 8 characters/entry in the  
 name field  
 10 characters/entry in  
 number field  
 Memo: 12 characters/entry in title  
 field  
 18 characters/entry in body  
 field  
 To Do: 30 characters/entry in  
 description field  
 Expense: 6 characters/entry in Amount  
 field  
 4 characters/entry in  
 Payment Type field  
 11 characters/entry in Memo  
 field

\* Maximum storage in each application: 5,000 entries

Maximum data size per entry	Approx. 2,000 bytes (including separator / terminator)
User interfaces	Keyboard
Other features	Secret function, data transfer, search function, et al.
Calculator digits	12

Functions Addition, subtraction, multiplication, division, constant, memory calculation, conversion calculation.

### Clock

Crystal oscillation frequency	32,768 Hz
Accuracy	Average variance per day, 2 seconds (at 25°C/77°F)
Display information	Year, month, day, day of the week, hours, minutes, AM/PM, city names.
Time system	12-hour or 24-hour
Other functions	Display of date and time for various cities around the world. Enable/disable daylight saving time.

### Peripherals and Data transfer interface

IR transfer	Up to a distance of approx. 80 cm. (only OZ-750 Organizers has this function)
Cable jack	4-pin connector

### Common

Power	Battery: 3 V  DC, alkaline batteries (LR6 (size "AA") x 2)
-------	--

Power consumption	0.33 W	Operating temperature	0°C to 40°C (32°F to 104°F)
Battery life	<p>Battery life may vary depending on usage.</p> <ul style="list-style-type: none"> <li>* Approx. 120 hours. Continuous display at an ambient temperature of 25°C (77°F)</li> <li>* Approx. 100 hours. Searching data for 5 minutes and display on for 55 minutes per hour, at an ambient temperature of 25°C(77°F)</li> <li>* Approx. 90 hours. Using the Backlight for 2 minutes per hourly use and searching for 5 minutes per hourly use at an ambient temperature of 25°C(77°F)</li> <li>* Please be reminded that the old batteries in the Organizer should be exchanged with new one at least once a year.</li> </ul>	Dimensions	<p>Open 162(W) x 145(D) x 10.9(H)mm 6-3/8(W) x 5-23/32(D) x 7/16(H)inch</p> <p>Closed 162(W) x 81.5(D) x 19.9(H)mm 6-3/8(W) x 3-7/32(D) x 25/32(H)inch</p>
		Weight	<p>OZ-730: 220 g (including batteries)</p> <p>OZ-750: 220 g (including batteries)</p>
		Accessories	<p>Alkaline batteries LR6 (size "AA") x 2, Operation manual, Quick Start Guide, Docking module, Software CD-ROM</p>
Backlight life	<p>Backlight life may vary depending on usage.</p> <p>If the backlight is on for 10 minutes per day (eg. 1 minute 10 times a day), the brightness will be reduced by half after 10* years (at an ambient temperature of 25°C and 65% humidity).</p> <ul style="list-style-type: none"> <li>* This figure may vary depending on the surrounding environment.</li> </ul>		

# Index

## A

- Accessing
  - Secret entries 57
- Alarms
  - Schedule 25
- All reset 63
- Birthday / Ann (Anniversary) application 29
- Application 11
  - Opening 13
  - Keys 5
- Assigning
  - Due date 27
  - Priority 26
- Auto power off 10
- Autorun 61, 62

## B

- Backlight 10
- Battery
  - Installing 6
  - Life 67
  - Replacement 64
- Blocks
  - Copying /moving 47
  - Working with blocks of text 18

## C

- Calc(ulator) application 35
  - Date calculations 24
- Calculations
  - Examples 36
  - Performing 35
  - Date calculation 24
- Conversion 36
- Calendar application
  - Setting up the initial display 59
- Calendar view
  - Daily 23
  - Monthly 23
  - Selecting 23
  - 3-month 23
- Caring for the Organizer 4
- Categories
  - To Do application; category list 28
- Changing
  - (see also customizing)
  - Large font view 60
  - Calendar format 59
  - Local city (Clock) 38
- Checking
  - Current time / date 21
  - Memory 21
  - Time in a city 40
- Checking off To Do entries 28
- Clock application 38
- Copying
  - Blocks of text 18, 47
  - Entries 48

Cursor 17  
Cut 18, 47, 48

## D

Daily view 23  
Date calculation 24  
Date format  
    Setting 59  
Daylight Saving Time (DST) 41  
    Assigning to a city 41  
    Enabling / disabling 41  
Deleting  
    All Secret entries 58  
    Single entry 20  
    Text 18  
    Using the application menu 20  
Display  
    Setting LCD contrast 10  
    Symbols 12  
Display modes  
    Edit mode 14  
    Index mode 13  
    View mode 14

## E

Edit mode 14  
Editing Techniques 16  
Editing  
    Categories 28  
    Entries 16  
Exchanging information with Personal Computer 52

## F

Fields 16  
Finding entries 18, 34  
    (see also Search)  
    By date 19  
    Using keywords 19  
    Using the index mode 18  
Font  
    Changing large font view 60

## I

Index mode 13  
Infrared transfer 51  
Initializing 7  
Installing  
    Batteries 6

## K

Key beep 10  
Keyboard 12

## L

Local city 8, 38  
Locking the Organizer 56

## M

Marking entries as secret 57  
Memo application 33  
Memory check 21

## 70 | Index

Menu 11  
Application 24, 26, 29, 32, 34, 42, 46

Moving  
Blocks of text 47  
Entries 48

## N

New entry  
Making 15, 26, 33, 43

## O

Organizer Link 52  
Owner Information 55

## P

Part names and functions 5  
Password  
Deleting / changing 58  
Forgotten 58  
Registering 56  
Paste 18, 47  
PC Link 52  
Pop-up List / menu 11  
Power  
Auto power off 10  
Turning on and off 10

## R

Replacing  
Operating batteries 64

## S

Schedule alarms 25  
Clearing 25  
Setting 25  
Schedule application 24  
Scroll the display 18  
Search  
(see the Finding)  
By keyword 19  
By date 19  
Search function 18  
Secret function 56  
Selecting  
Calendar views 23  
Date 23  
Display modes 13  
Setting  
Clock 8, 38  
Date Format 59  
LCD contrast 10  
Local city 38  
Owner Information 55  
Password 56  
Schedule alarms 25  
Start-up display 9, 55  
World city 40  
Setting up  
Calendar's initial display 59  
For data transfer 51  
Start-up display  
Setting 9, 55

## Symbols

- On the display 12
- Entering 48

**T**

- Tel application 31
- To Do application 26
- Transferring data
  - Between two OZ-750 51
  - Organizers
    - With an Organizer other than OZ-750 51
    - Single entries 52
    - Via infrared 51
  - With a personal computer 52
- Turning on / off
  - Key beep 10
  - Power 10
  - Setup display 9
- Typing in text
  - Letters 17
  - Numbers 17
  - Symbols 17

**U**

- Unlocking the Organizer 56

**W**

- World City 40





## Product Support

**Sharp Electronics Corporation is dedicated to serving Customer needs. Please fill out and send the enclosed registration card so that we can keep you up-to-date as new products and services become available.**

If you have read the ORGANIZER operation manual and the Quick Start Guide, but you still require product support, you can:

Call a Sharp Representative  
630-378-3590

Visit our Web Site  
<http://www.sharp-usa.com>

Send an E-mail  
Internet account: [pdasupport@sharpsec.com](mailto:pdasupport@sharpsec.com)

Write to our Customer Assistance Center  
Sharp Electronics Corp.  
Customer Assistance Center  
Att: WIZARD HELP  
1300 Naperville Drive  
Romeoville, IL 60446



## Troubleshooting

Refer to the list below for solutions when the unit is not functioning properly before contacting your local SHARP dealer:

Problem	Solution
The display remains blank after pressing  .	* Adjust the LCD contrast (see p.10) * Install new batteries (see p.6)
Poor display contrast.	Adjust the LCD contrast (see p.10)
The Organizer is turned on, but pressing Keys has no effect.	Reset the Organizer (see p.63)
“Not enough memory” displayed.	The Organizer’s memory is full or nearly full. Delete unnecessary data. (You can check the amount of free memory using CHECK MEMORY in the Second Main Menu, see p.21).
The alarm does not sound at the set time.	Enable alarms in the SOUND application in the Second Main Menu. (see p.10)
The Backlight does not function.	During data transfer, PC-LINK mode, the Backlight does not work, if Battery Alert appears, replace batteries. (see P.64).

## CONSUMER LIMITED WARRANTY

SHARP ELECTRONICS CORPORATION warrants to the first consumer purchaser that this Sharp brand product (the "Product"), when shipped in its original container, will be free from defective workmanship and materials and agrees that it will, at its option, either repair the defect or replace the defective Product or part thereof with a new or remanufactured equivalent at no charge to the purchaser for parts or labor for the period(s) set forth below.

This warranty does not apply to any appearance items of the Product nor to the additional excluded item(s) set forth below nor to any Product the exterior of which has been damaged or defaced, which has been subjected to improper voltage or other misuse, abnormal service or handling, or which has been altered or modified in design or construction.

In order to enforce the rights under this limited warranty, the purchaser should follow the steps set forth below and provide proof of purchase to the servicer.

The limited warranty described herein is in addition to whatever implied warranties may be granted to purchasers by law. ALL IMPLIED WARRANTIES INCLUDING THE WARRANTIES OF MERCHANTABILITY AND FITNESS FOR USE ARE LIMITED TO THE PERIOD(S) FROM THE DATE OF PURCHASE SET FORTH BELOW. Some states do not allow limitations on how long an implied warranty lasts, so the above limitation may not apply to you.

Neither the sales personnel of the seller nor any other person is authorized to make any warranties other than those described herein, or to extend the duration of any warranties beyond the time period described herein on behalf of Sharp.

The warranties described herein shall be the sole and exclusive warranties granted by Sharp and shall be the sole and exclusive remedy available to the purchaser. Correction of defects, in the manner and for the period of time described herein, shall constitute complete fulfillment of all liabilities and responsibilities of Sharp to the purchaser with respect to the Product, and shall constitute full satisfaction of all claims, whether based on contract, negligence, strict liability or

otherwise. In no event shall Sharp be liable, or in any way responsible, for any damages or defects in the Product which were caused by repairs or attempted repairs performed by anyone other than an authorized servicer. Nor shall Sharp be liable or in any way responsible for any incidental or consequential economic or property damage. Some states do not allow the exclusion of incidental or consequential damages, so the above exclusion may not apply to you.

THE WARRANTY GIVES YOU SPECIFIC LEGAL RIGHTS. YOU MAY ALSO HAVE OTHER RIGHTS WHICH VARY FROM STATE TO STATE.

<u>Your Product:</u>	Electronic Organizer
<u>Warranty Period for this Product:</u>	One (1) year parts and labor from date of purchase.
<u>Additional items exclude from warranty coverage:</u>	Disk media supplied with this Product is warranted for replacement only and limited to ninety (90) days from date of purchase. Any consumable items (such as paper, ink, or non-rechargeable batteries) and any external hardware, software, firmware, or peripherals other than the Product are excluded from warranty coverage.
<u>Where to obtain service:</u>	From a Sharp Authorized Servicer located in the United States. To find the location of the nearest Sharp Authorized Servicer, call Sharp toll free at
<u>What to do to obtain service:</u>	Ship your Product prepaid to a Sharp Authorized Servicer. Be sure to have proof of purchase available. If you ship the Product, be sure it is insured and packaged securely.

TO OBTAIN SUPPLY, ACCESSORY OR PRODUCT INFORMATION, CALL

<http://www.sharp-usa.com/>.

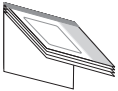

### Changing the batteries:

When using the organizer, if the battery replacement message appears on the display, the batteries should be replaced as soon as possible.

1. Turn off the Organizer.
2. Set the battery replacement switch on the bottom of the Organizer to REPLACE BATTERIES. (A red dot will appear.)
3. Slide off the batteries cover.
4. Remove the old batteries by pulling the ribbon tab.
5. Insert the two new batteries on top of the ribbon tab, taking care to position them correctly according to the plus (+) and minus (-) terminals.
6. Replace the cover.
7. Set the battery replacement switch to NORMAL OPERATION.

**SHARP**<sup>®</sup>

**WIZARD**

## Electronic Organizer Quick Reference Guide



**OZ-730 / OZ-750**

Tech Support      630-378-3590  
Web Site            [www.sharp-usa.com](http://www.sharp-usa.com)  
E-mail: [pdasupport@sharpsec.com](mailto:pdasupport@sharpsec.com)

Customer Assistance Address:



Sharp Electronics Corp.  
Customer Assistance Center  
ATT: WIZARD HELP  
1300 Naperville Drive  
Romeoville, IL 60446



### Tel Application:



Used for managing a wide range of information, from a simple address book to an extensive restaurant guide or even a listing of your important business contacts. Press , then press . Type in the information as prompted, and finally press  to store.

### Search Function:

This function allows you to locate any previously stored entry by using partial or specific data as a search key.

1. Open the desired application.
2. Press   .
3. Type in any word stored in the entries you want to find.

 To search only secret entries, press   to check the SECRET ONLY item, if the Organizer is unlocked.

4. Press  to begin the search.
5. Press  to see additional entries that contain the searched text, then press  when you find the desired entry.

### **Edit mode:**

Provides the ability to modify any entry that was previously entered into the organizer.

1. Find an entry that you wish to change.
2. Press **2nd** **NEW** to go to Edit mode.
3. Move to the field you want to change.
4. Make any desired changes.

NOTE: You can highlight any text using **⏪** and the cursor keys, and then delete the text (by pressing **DEL**) or cut the text (by pressing **2nd** **X** to paste it elsewhere).

If you make a mistake and want to restore the original entry, simply press **ESC**.

### **Birthday / Ann (Anniversary) Application:**

Makes it easy for you to keep track of annual events, such as wedding anniversaries and birthdays of friends, relatives and business associates. Select Birthday / Ann in the Main Menu, then press **ENTER**. Press **NEW**, and Anniversary by Date appears. Enter the month and day, then the description, and press **ENTER** to store.

### Schedule Application:

Used for tracking meetings, appointments and time-sensitive data. Press **NEW**, then press **NEW**.

If you want to use a different date, move up to the DATE field and press the **DATE** key. Press **▲** or **▼** to select the desired month, then use the cursor keys to select the day of the appointment. Press **ENTER** when done. Move to the TIME field and type in the start and end times for your appointment, then press **▼**. Type in a description for the appointment. Press **ENTER** to store the entry.

### Cut / Copy / Paste / Select:

Eliminates the need to retype common data or to simply relocate specific information.

1. Display in Edit mode the entry containing the text you want to copy or cut.
2. Move to the start of the text you want to copy or cut.
3. While holding down **⇧**, use the cursor keys to select the text you want to copy or cut. The selected text is displayed in reverse (white-on-black).
4. Press **2ND** **C** or **2ND** **X** to copy or cut the selected text.
5. Display in Edit mode the entry to which you want to add the copied or cut text, and press **2ND** **V**.

### My Programs:

Basic add-in data can be downloaded into the Organizer with a maximum capacity of 10 programs in this application.

1. Download a program into the Organizer.
2. Press **My Programs** to view list of installed programs.
3. Launch the application by pressing **1** - **0** that corresponds to the application.

### Autorun:

You can set an autorun of basic application once power is turned on.

1. Activate the autorun first in Start-up Display in the Second Main Menu.
2. Open the application menu of My Programs and select AUTORUN.
3. Select the application for autorun in the Autorun screen.

### Key Assignment:

Used for short-cut entry of self-assigned applications by using function keys. Three function keys are available for key assignment.

1. Highlight the application for key assignment first.
2. Press **Menu** and select ASSIGN TO KEY then press **ENTER**.
3. Press the respective number key.
4. Press the assigned key can enter the application chosen before.

### To Do Application:

Used for organizing and tracking tasks and objectives, assigning them priorities, and assigning a category to each entry, making it possible to access them selectively in a variety of ways. Press **MAIN** to enter the Main Menu and select To Do and then press **ENTER**. Press **NEW** and enter a description of the task, then press **↓**. Enter DUE DATE, which is the date by which the task must be completed.

Move to the PRIORITY field by pressing **↓** and select priority using **←** and **→**. The Priority values are used to sort the entries in the Index mode. Press **↑** to move to the CATEGORY field. Press **☐** to open the pop-up menu and select the desired category. Press **ENTER** to store the entry.



### **Memo Application:**

Used as a simple yet powerful means of recording information, from meeting notes to memorandums and letters.

Press **MAIN** to enter the Main Menu and select Memo. Type in a title after pressing **NEW**. Then press **↓** to move to DESCRIPTION field to enter a description. Press **←** to start a new line in the document. Press **ENTER** to store the entry.

### **Password / Secret Function:**

This function allows you to keep selected information in your organizer secure by locking it with a password that you specify. Entries that you have marked as secret cannot be accessed until the organizer is unlocked using the password.

#### Turning on the Lock

1. Press **MAIN** twice to enter the Second Main Menu.
2. Select Secret from the menu, then press **ENTER**.
3. Select LOCK ORGANIZER, then press **ENTER**.
4. Enter any password up to sixteen characters long and then press **ENTER**.
5. Re-type the password to confirm and then press **ENTER** to store the password (or **ESC** to cancel the operation).
6. Press **ENTER**.

## Clock:

Makes it possible not only to know the correct time and date in your area, but also to know the time in other cities or any region around the world.

### Setting the time and date

1. Select Clock in the Second Main Menu, then press **ENTER**.
2. Press **MENU** to open the Clock menu.
3. Select ADJUST TIME / DATE and press **ENTER**.
4. Select the TIME SYSTEM field. Press **←** or **→** to indicate whether you want the time shown in 12- or 24- hour format.
5. Move to the LOCAL DATE field. Enter the current month and day each in two digits, and the year in four digits.
6. Move to the LOCAL TIME field. Enter the current time (and press **A** (AM) or **P** (PM) if you select 12-hour format in the TIME SYSTEM).
7. Press **ENTER** (or **ESC** to cancel the changes).

## Expense application:

A sophisticated and easy-to-use tool for managing your personal and business finances, etc.

1. Press **MAIN** to enter the Main Menu and select Expense, then press **ENTER**.
2. Press **NEW**.
3. Press **▲** to move to the CATEGORY field. Press **☒** to select the desired category.
4. Enter the date in the order of month, day, year.
5. Press **▼** to move to the AMOUNT.
6. Enter the expense amount using up to ten digits including up to two decimal places.
7. Move to the PAYMENT TYPE field. Press **☒** to select the desired payment type. Press **1** - **7** to select the desired item.
8. Move to the MEMO field and use the keyboard to input the description of the expense.
9. Move to the STATUS field. Press **☒** to select the desired status mode.
10. Press **ENTER** to store the entry.

### Calculator:

Provides a 12-digit calculator which performs mathematical operations.

To use the calculator, select Calc from the Main Menu, then press **ENTER**.

### Conversions:

#### Performing a conversion

1. Select Conversion in the Main Menu.
2. Press **ENTER** to open the conversion index display.
3. Press **▲** or **▼** to select the desired item.
4. Press **ENTER**.
5. Enter the amounts you want to convert, then press **◀** or **▶**.

#### Changing the currency rate

1. Select Conversion in the Main Menu.
2. Press **ENTER** to open the conversion index display.
3. Select the desired currency item and press **ENTER**.
4. Press **2ND** **NEW** to change the rate.
5. Press **C** to clear the original rate first, then enter the new rate.
6. Press **▲** to move to the currency name field and make the desired changes.
7. Press **ENTER** when you have finished (or **ESC** to cancel the changes).