

# Medical Batteries

Replacement batteries  
for Healthcare Technology Management



**R&D BATTERIES, INC.**

A Value Added Center For



March 2015

**1 • 800 • 950 • 1945**

*Order online at [RDbatteries.net](http://RDbatteries.net)*

# QUICK INDEX

<b>MEDICAL BATTERIES</b>	Pages 6 to 72	Medical
<b>UPS BATTERIES</b>	Pages 73 to 97	UPS
<b>Radio</b>	Pages 98 to 100	Radio
<b>Laptop</b>	Pages 101 to 111	Laptop
<b>Lighting</b>	Pages 112 to 116	Lighting
<b>Tool</b>	Pages 117 to 123	Tool
<b>Mobility Lifts</b>	Pages 124 to 130	Mobility Lifts
<b>X-Ray</b>	Pages 131 to 133	X-Ray
<b>Physio Control</b>	Pages 134 to 136	Physio Control
<b>ZOLL</b>	Pages 137 to 141	ZOLL
<b>Barcode</b>	Pages 142 to 144	Barcode
<b>Primary</b>	Pages 145 to 153	Primary
<b>Secondary VRLA</b>	Pages 154 to 167	Secondary VRLA
<b>Misc</b>	Pages 168 to 170	Misc
<b>Chargers</b>	Pages 171 to 172	Chargers
<b>Lamps</b>	Pages 173 to 186	Lamps

# MEDICAL BATTERIES TABLE OF CONTENTS

ABBOTT LABORATORIES (HOSPIRA, ROSS)	6	BLUE SKY MEDICAL	17
ABIOMED	7	BOSTON SCIENTIFIC (MANSFIELD)	17
ACME MEDICAL SCALES	7	BREAS	17
ACOMA MEDICAL	7	BRENTWOOD (FUKUDA DENSHI)	17
ACUSON	7	BULLARD	17
ADVANCED MEDICAL SYSTEMS	7	BURDICK (QUINTON, SIEMENS, SPACELABS)	18
ADVANCED TECHNOLOGY LABORATORIES	7	CAMBRIDGE INSTRUMENTS (AMERICAN OPTICAL & PICKER INT'L)	18
AEQUITRON MEDICAL	8	CAMINO LABORATORIES	18
AEROGEN (NEKTAR)	8	CAMTEC	19
AEROS INSTRUMENTS (OHIO MEDICAL CORPORATION)	8	CARAPACE	19
AIRBORNE LIFE SUPPORT SYSTEMS (INTERNATIONAL BIOMEDICAL)	8	CARDIAC SCIENCE (SURVIVALINK)	19
AIRSEP CORPORATION	8	CARDIO DYNAMICS	19
AITECS	8	CARDIOLINE (REMCO)	19
ALARIS MEDICAL (CARDINAL HEALTH)	8	CARDIOVIVE	19
ALCON LABORATORIES, INC.	9	CAREFUSION	19
AMERICAN DIAGNOSTIC CORP.	10	CAS MEDICAL SYSTEMS (BIO LOGIC DEVICES)	19
AMERICAN SCALE	10	CASTLE STERILIZER (SHAMPAINÉ)	20
AMSCO (STERIS)	10	CDX	20
AMVEX	10	CENTRON TECHNOLOGIES CORP.	20
APEX HEALTHCARE	10	CHATTANOOGA GROUP	20
ARJO HUNTLEIGH	10	CLINICAL DYNAMICS	20
ARROW INTERNATIONAL	11	COBE CARDIOVASCULAR (SORIN)	20
ARTROMICK	11	COLIN MEDICAL INSTRUMENTS (OMRON)	20
ARVEE MEDICAL	11	CONTINENTAL SCALE	21
ASPECT MEDICAL SYSTEMS	11	COROMETRICS MEDICAL	21
ASPEN LABS (ZIMMER)	11	CORPAK (CORFLO)	21
ASTRO-MED	11	CRITICARE SYSTEMS, INC.	21
ATMOS	12	CRITIKON (GE, SENSOR MEDICS)	22
AUTOGENIC SYSTEMS	12	CU MEDICAL SYSTEMS	23
AVI (3M HEALTHCARE)	12	CURLIN MEDICAL	23
A-VOX SYSTEMS	12	CYBEX	23
BARDSYSTEMS (DIAGNOSTIC ULTRASOUND, SITE MICRO)	12	DATASCOPE / MINDRAY	23
BAXTER (TRAVENOL, SABRATEK, SIGMA)	12	DATEX-OHMEDA (OHMEDA)	24
B. BRAUN (MCGAW, AMERICAN EDWARDS LABS)	13	DAVICON	25
BEAR MEDICAL SYSTEMS (VIASYS, BIRD)	14	DEFIBTECH	25
BELMONT INSTRUMENT CORP.	14	DELMAR MEDICAL SYSTEMS	26
BENNETT X-RAY TECHNOLOGIES	14	DELPHI MEDICAL	26
BERCHTOLD CORP.	15	DEPUY	26
BEST	15	DETECTO SCALE	26
BFW	15	DEVILBISS (PULSAIR, SUNRISE MEDICAL)	26
BHM MEDICAL, INC. (ERGOLIFT)	15	DIGITRON (S.R. INSTRUMENTS)	26
BIOCHEM, BCI (NONIN MEDICAL)	15	DOLPHIN MEDICAL	26
BIODEX MEDICAL SYSTEMS, INC.	16	DRAEGER (NARCO, SIEMENS)	26
BIOHIT	16	DUKANE	27
BIO LOGIC DEVICES (AXON, CAS MEDICAL)	16	DYNATECH NEVADA (TRIMED, QUEST MEDICAL)	27
BIOMEDICAL DESIGN INSTRUMENTS	16	DYNEX	27
BIO-MEDICAL DEVICES	16	DYONICS	27
BIONET	16	EDENTECH (NELLCOR)	28
BIO-TEK INSTRUMENTS	16	ELECTROMEDICS	28
BIRD PRODUCTS CORPORATION (VIASYS, BEAR)	17	ELMED INSTRUMENTS	28
		ERGOLET	28
		ERGOTRON	28

# MEDICAL BATTERIES TABLE OF CONTENTS

ESHMANN	28	KONTRON (ROCHE, ARROW INTERNATIONAL)	35
EVO MEDICAL	28	KOWA	36
EXECUTONE INFORMATION SYSTEMS	28	LAERDAL (CARDIAC RESUSCITATOR)	36
FERNO ILLE	28	LARSEN & TOUBRO	36
FISHER-BERKELEY	28	LIFE LINE SYSTEMS	36
FISHER SCIENTIFIC	28	LIFELOC TECHNOLOGIES	36
FLO HEALTHCARE	29	LIFE SYSTEMS	37
FLUKE (METRON)	29	LIFETECH, INC.	37
FORMA SCIENTIFIC	29	LIKO	37
FUKUDA DENSHI (BRENTWOOD)	29	LIONVILLE SYSTEMS	37
GAMBRO	29	MAQUET-STIERLEN	37
GENERAL ELECTRIC (CRITIKON, MARQUETTE)	29	MARCAL (GRASEBY)	38
GENESIS	31	MARCO	38
GETINGE	31	MARQUETTE ELECTRONICS (GE)	38
GRAMS MEDICAL	31	MASIMO	39
GRIESHABER	31	MATRX MEDICAL INC.	40
GULDMANN	31	MEDCARE PRODUCTS	40
HALL	31	MEDELA USA	40
HAMILTON	31	MEDFUSION SYSTEMS (IVION, VALLEY LABS)	40
HEALTHDYNE TECHNOLOGIES (NARCO, RESPIRONICS)	31	MEDICAL DATA ELECTRONICS	41
HEARTSINE	32	MEDICAL INDUSTRIES OF AMERICA	41
HEINE	32	MEDICAL RESEARCH LABS (MRL)	41
HELENA LABRATORIES (ARRAY MEDICAL)	32	MEDICAL SYSTEMS INTERNATIONAL CORPORATION	41
HENLEY INTERNATIONAL	32	MEDICAL TECHNOLOGY PRODUCTS, INC.	42
HESKA VETERINARY	32	MEDI-MAN PRODUCTS	42
HILLROM	32	MEDIMEX INC.	42
HOKANSON	33	MEDIWATCH	42
HOSPIRA	33	MED RAD	42
HOYER (INVACARE & LINAK)	33	MENNEN MEDICAL INC.	42
ILC Dover	33	MENTOR	42
IMEX (MEDASONICS, NICOLET VASCULAR, VIASYS)	33	MICRO MEDICAL	42
IMPACT	33	MICROPACE	43
INFRASONICS (NELLCOR, PURITAN BENNETT)	34	MICROVAS TECHNOLOGIES	43
INNERSPACE	34	MIDMARK INC. (SCHEARER)	43
INOGEN	34	MINDRAY (DATASCOPE)	43
INSTRUMED	34	MINOLTA (KONICA MINOLTA, MARQUEST)	43
INTELLIGENT MEDICAL SYSTEMS (FIRST TEMP)	34	MINRAD	43
INTELLIKEY COROPORATION	34	MIRA	43
INTERNATIONAL TECHNIDYNE (HEMOCHRON, TECHNIDYNE)	34	MLA SYSTEMS	43
INVIVO RESEARCH	34	MOLIFT	43
INVOS	35	MORTARA INSTRUMENTS	43
ITC	35	NARCO AIR SHIELDS (DRAEGER, HEALTHDYNE, VICKERS)	44
IVY BIOMEDICAL SYSTEMS	35	NATUS MEDICAL	44
JACO	35	NELLCOR (AEQUITRON, INFRASONICS, PURITAN BENNETT)	44
JEWETT REFRIGERATOR	35	NEWPORT MEDICAL INSTRUMENTS, INC.	45
JONES MEDICAL INSTRUMENTS	35	NIHON KOHDEN	45
KEELER	35	NOVAMATRIX MEDICAL	46
KELLER MEDICAL	35	NxStage	46
KINETIC CONCEPTS	35	OEC	46
		OHMEDA (DATEX)	47

# MEDICAL BATTERIES TABLE OF CONTENTS

OLYMPIC MEDICAL	48	SENCORE (BAPCO)	60
OLYMPUS MEDICAL	48	SENSOR MEDICS (CRITIKON, GOULD)	60
OMEGA	48	SEPARATION TECHNOLOGIES	60
OMNICELL	48	SERVOX (JEDCOM, ROMEX)	60
OMRON HEALTHCARE	48	SHERWOOD MEDICAL	60
ORDION	48	(CHESEBROUGH-PONDS, FILAC)	
OSI (MIZUSHO)	48	SHIMADZU	61
OTODYNAMICS	49	SIEMENS MEDICAL SYSTEMS (QUANTUM, SERVOX, BURDICK)	61
PACE TECH (CHATILLON, VITAL TECHNOLOGY)	49	SIGMA	62
PALCO LABORATORIES	49	SIGNTEX INC.	62
PARA-TEK	49	SITE MICRO SURGICAL SYSTEMS (DYMAX)	62
PARKS ELECTRONICS LABS	49	SKYTRON	62
PENLON	49	SMITH & NEPHEW CO.	62
PHILIPS (HEWLETT PACKARD)	49	SMITH'S MEDICAL	62
PHS West	53	SONICAID (OXFORD MEDICAL)	63
PHYSIO-CONTROL (FIRST MED, MEDTRONIC)	53	SPACELABS (BURDICK)	63
PHYSIOMED	55	SPECTRALINK	63
PPG BIOMEDICAL SYSTEMS (LITTON-DATAMEDIX)	55	SPIROLAB	64
PRECISION MEDICAL	55	SPIROMETRICS INC.	64
PROPPER MANUFACTURING	55	SPO MEDICAL	64
PROTOCOL SYSTEMS	55	SSCOR INC.	64
PULMONETIC SYSTEMS	56	STEREO OPTICAL COMPANY (COPELAND OPTEC)	65
PURITAN BENNETT (INFRASONICS, NELLCOR)	56	STERIS (ALSO SEE AMSCO)	65
QMED	57	STILLE IMAGING	66
QUEST MEDICAL INC. (DYNATECH NEVADA)	57	STIMTECH (CODMAN)	66
QUINTON (BURDICK)	57	STRYKER INSTRUMENTS	66
RACAL	57	SUNRISE MEDICAL (DEVILBISS)	66
RADIOMETER AMERICA	57	SUNTECH	67
RADIONICS	57	SUPERIOR HEALTH CARE GROUP	67
RAININ	57	SURGITEK (ENDOTEK)	67
RAULAND BORG	58	SYLVAN (FIBER OPTIC)	67
RESPIRONICS (LIFECARE, HEALTHDYNE)	58	TERUMO	67
REVCO	58	T.H.E. MEDICAL	67
RIGEL	58	THORATEC	67
RN PLUS (NURSE ASSIST, INC.)	59	3M HEALTHCARE (CENTRIMED, RACAL & SARNES, AVI)	67
ROCHE	59	TIOTU	68
RUBBERMAID	59	TRANSMOTION MEDICAL	68
SABRATEK (BAXTER)	59	TRUMPF	68
SAMMONS PRESTON	59	TYCO HEALTHCARE (KENDALL)	68
SANDOZ (NOVARTIS)	59	US IMAGING	68
SANYO	59	U.S. SURGICAL	68
SCALE-TRONIX, INC.	59	VALLEY LABS (IVION, MEDFUSION)	68
SCHAERER MAYFIELD	59	VANCARE	69
SCHILLER AMERICA (WELCH ALLYN)	59	VAPOTHERM	69
SCHUCO, INC. (ALLIED HEALTHCARE, GOMCO)	59	VARIDYNE	69
SEBRA (BAXTER)	60	VERATHON (BVI)	69
SECA	60	VERSAMED	69
SECHRIST INDUSTRIES	60	VITROS (KODAK)	69
SEIKO INSTRUMENTS	60	VOLARO	69
		WALKMED	69
		WELCH ALLYN (GRASON-STADLER, PROTOCOL)	69

# MEDICAL BATTERIES TABLE OF CONTENTS

WESCOM	71
WR MEDICAL (HILGER)	71
ZEVEX	71
ZOLL (ZMI)	72
ZONARE MEDICAL SYSTEMS	72
ZYNO	72

**ABBOTT LABORATORIES (HOSPIRA, ROSS)**

Aim Plus Infusion Pump (660-76000-01) (Memory)	3 Volt / .16 Ah	5924	\$6.75
Aim Plus Infusion Pump (765-600012-002) (Retrofit/Exchange)	4.8 Volt / 3.8 Ah	6187	\$60.00
Cardiac Output Computer 41234, Flexiflo Portable Nutrient Pump	6 Volt / 1.0 Ah	5368	\$9.00
Cell Dyn 1700 Cell Counter, Hematology Analyzer	3.6 Volt / .11 Ah	5449	\$11.25
DH1, DH2, DH3 Defibrillator	12 Volt / 2.5 Ah	5386	\$20.00
DH5 Monitor Defibrillator (Requires 2/unit)	24 Volt / 1.8 Ah	5312	\$130.00
Embrace Enteral Pump	4.8 Volt / 1.6 Ah	6095	\$35.00
Flexiflo Companion 83, 84	4 Volt / 1.0 Ah	5346	\$35.00
Flexiflo II Enteral Pump	6 Volt / 2.5 Ah	5223	\$20.00
Flexiflo III Revision T - X	6 Volt / 2.5 Ah	5223	\$20.00
Flexiflo III Revision Y - Z	6 Volt / 2.8 Ah	5370	\$15.00
Flexiflo Portable Nutrient Pump	6 Volt / 1.0 Ah	5368	\$9.00
Flexiflo Quantum Enteral Pump (Powersonic)	8 Volt / 3.2 Ah	5275-P	\$25.00
Flexiflo Quantum Enteral Pump (Sonnenschein)	8 Volt / 2.7 Ah	5275	\$54.00
Gemstar (Clock)	3 Volt / .240 Ah	6180	\$4.50
Gemstar (NiMH) (Send in for Retrofit)	2.4 Volt / 4.0 Ah	6374	\$28.00
i-Stat Handheld Blood Analyzer (06F23-55)	8.4 Volt / .180 Ah	5398	\$9.45
i-Stat (MJ09.01)	4.8 Volt / 1.6 Ah	6192	\$25.00
i-Stat System (Requires 2/unit)	9 Volt / 1.2 Ah	5868	\$5.95
Life Care 1000, 1050 Volumetric Controller	6 Volt / 2.5 Ah	5015	\$27.75
 Life Care 175 Breeze, 4, 4P, 5, 5000, 5500, 6000, XLD Plum, Micro Pump, Acclaim 12032, Acclaim Encore 12337, Cardiac Output Unit 3300 (Sonnenschein, 2 pin)	8 Volt / 2.7 Ah	5536	\$58.50
Life Care 2D, 3D, 3HB, 4D Infusion Pump (Requires 2/unit)	6 Volt / 2.5 Ah	5015	\$27.75
Life Care 4100, PCA Plus II, PCA 3 (830-03650-905) (Sonnenschein)	8 Volt / 2.7 Ah	5536	\$58.50
 Life Care 4, 4P, 4100, 5, 5000, 5500, 6000 Plum, Micro Pump, PCA Plus II, PCA 3, Cardiac Output Unit 3300 (EnerSys, 2 pin)	8 Volt / 2.5 Ah	5016	\$37.00
 Life Care 4, 4P, 5, 5000, 5500, 6000 Plum, Micro Pump, Acclaim 12032, Acclaim Encore 12337, Cardiac Output Unit 3300 (Powersonic, 2 pin)	8 Volt / 3.2 Ah	5536-P	\$25.00
 Life Care 5000 Plum, Plum XL, Plum XLM, PCA III Infusion Pumps (Powersonic, 4 pin) (1-3/unit)	8 Volt / 3.2 Ah	5875-P	\$25.00

**ABBOTT LABORATORIES (HOSPIRA, ROSS) ... continued from previous page**



Life Care 5000 Plum, Plum XL,  
Plum XLM, PCA III Infusion Pumps  
(Sonnenschein, 4 pin)  
(830-03650-905) (1-3/unit)

8 Volt / 2.7 Ah 5875 \$58.50

Life Care 75 Breeze	6 Volt / 3.2 Ah	5373	\$22.00
Life Care 900 Volumetric Pump	12 Volt / 3.4 Ah	5384	\$25.00
Life Care PCA Infusor 1821	6 Volt / 2.5 Ah	5252	\$25.00
Life Care XL-3M Plum Micro/Macro (830-94321-901)	8 Volt / 3.8 Ah	5792	\$80.00
Omni Flo 4000, 4000 Plus Infusion Pump (642-76006-001)	12 Volt / 2.5 Ah	5515	\$20.00
Patrol Enteral Pump	6 Volt / 4.5 Ah	5881	\$16.00



Plum A Plus, A Plus 3 Infusion  
Pump (840-95066-002)

6 Volt / 4.5 Ah 5078 \$16.00

Symbiq Infusion Pump (HSP3566-E09) (OEM)	11.1 Volt / 6.6 Ah	6331	\$249.00
TENS Unit	1.2 Volt / .15 Ah	5578	\$2.50

**ABIOMED**

AB5000 (Requires 2/unit)	12 Volt / 12.0 Ah	5551	\$45.00
BVS 5000, 5000I Bi Ventricular Support (Requires 2/unit)	12 Volt / 13.0 Ah	5722	\$135.00
BVS 500T Transport Scale	12 Volt / 26.0 Ah	5970	\$194.00

**ACME MEDICAL SCALES**

2215, 5001, 7201, 7301, 7401, 8500 Scale (Requires 6/unit)	1.2 Volt / .70 Ah	5397	\$2.65
500, 1500, 2500, 2510, 3903, 4500, 5000, 7000, 7300,	12 Volt / 1.3 Ah	5383	\$18.50
7400 Bed Scale (Requires 2/unit)	12 Volt / 1.3 Ah	5383	\$18.50

**ACOMA MEDICAL**

MBA 130 Portable X-Ray (Requires 9/unit)	12 Volt / 26.0 Ah	5393	\$67.00
MBA 200 Portable X-Ray (Requires 20/unit)	12 Volt / 12.0 Ah	5551	\$45.00

**ACUSON**

Diagnostic Ultrasound 128, 128X, XP10 (8211107) (Memory)	3.9 Volt / 1.0 Ah	5727	\$34.50
--	-------------------	------	---------

**ADVANCED MEDICAL SYSTEMS**

AM66, FM660 Fetal Monitor	3.6 Volt / .11 Ah	5764	\$12.00
---------------------------	-------------------	------	---------

**ADVANCED TECHNOLOGY LABORATORIES**

800 Plus Ultrasound (Memory)	3.6 Volt / .15 Ah	5457	\$10.00
------------------------------	-------------------	------	---------



**ADVANCED TECHNOLOGY LABORATORIES ... continued from previous page**

Ultramark 4 Ultrasound System (Requires 4/unit)	1.2 Volt / .70 Ah	5397	\$2.65
UM4 Ultrasound (Requires 2/unit)	1.5 V Alkaline	5407	\$0.45
UM8 Ultrasound	6 Volt / 1.0 Ah	5368	\$9.00

**AEQUITRON MEDICAL**

8200, 9200, 9215, 9216, 9500, 9550 Infant Monitor	9.6 Volt / 2.3 Ah	5007	\$49.00
8850 Port-A-Vac	12 Volt / 3.2 Ah	5679	\$36.75
LP/0 (External)	12 Volt / 12.0 Ah	5820L	\$37.00
LP3, LP4 Volumetric Ventilator	12 Volt / 2.5 Ah	5128	\$58.00
LP5, LP6, LP10 Volumetric Ventilator (Memory)	3 Volt / .165 Ah	5483	\$3.90
LP5, LP6, LP6+, LP10, LP20 Volumetric Ventilator (003309-000)	12 Volt / 2.9 Ah	5548	\$38.00
MCR911D Muscle Stimulator (Requires 2/unit)	12 Volt / 7.0 Ah	5390	\$25.00

**AEROGEN (NEKTAR)**

Aeroneb Professional Nebulizer	4.8 Volt / .450 Ah	6069	\$18.00
--------------------------------	--------------------	------	---------

**AEROS INSTRUMENTS (OHIO MEDICAL CORPORATION)**

Care-E-Vac II Aspirator (AI5100250)	12 Volt / 3.4 Ah	5667	\$41.00
Care-E-Vac III (749144)	12 Volt / 5.0 Ah	6419	\$28.00
Tote-L-Vac Aspirator (749146, 753790)	12 Volt / 3.4 Ah	5667	\$41.00

**AIRBORNE LIFE SUPPORT SYSTEMS (INTERNATIONAL BIOMEDICAL)**

Infant Transport 20L, Voyager Lightweight	12 Volt / 13.0 Ah	5722	\$135.00
Infant Transport 750I	12 Volt / 26.0 Ah	5393	\$67.00
Infant Transport Incubator 185, 185A	12 Volt / 28.0 Ah	5850	\$110.00
Infant Transport Incubator 185A Plus, 20H, Voyager	12 Volt / 26.0 Ah	5970	\$194.00
LP3, LP4 Volumetric Ventilator	2 Volt / 5.0 Ah	5218	\$9.85

**AIRSEP CORPORATION**

Portable Oxygen Concentrator (BT007-1) (Send in for a Retrofit)	12 Volt / 3.0 Ah	6261	\$125.00
---	------------------	------	----------

**AITECS**

SP-125 Pro, SEP-105, SEP-105 Plus, SEP-125 Plus, SP-145, SEP21 Plus Syringe Pump (Set of 2)	9.6 Volt / 1.3 Ah	6307	\$49.50
---	-------------------	------	---------

**ALARIS MEDICAL (CARDINAL HEALTH)**

230, 530, 600 Volumetric Infusion Pump/Controller	12 Volt / .70 Ah	5024	\$33.00
260, 260+, 260IR, 262, 262A, 560, 560+, 565, 570 Pump	12 Volt / 2.5 Ah	5128	\$58.00
280, 580, 580 Plus, 590, 599 Star-Flow Volumetric Pump, 3080 Keofeed Enteral Feeding Pump	6 Volt / 3.4 Ah	5064 / 5489	\$30.00
4000, 4000A, 4000EE, 4200, 5200 Vital Check Monitor	12 Volt / 2.5 Ah	5167	\$56.00
4400, 4410, 4415, 4510 Vital Check Monitor	6 Volt / 4.5 Ah	5374	\$12.00
500, 3000 Keofeed Enteral Feeding Pump	12 Volt / 2.5 Ah	5515	\$20.00
700, 710 Syringe Infusior	8 Volt / 2.5 Ah	5016	\$37.00
Core Check Thermometer	9.0 V Alkaline	5405	\$1.80
Electronic Thermometer 2000	4.8 Volt / .70 Ah	5172	\$13.75
Electronic Thermometer 811(A), 817, 821(A), 822	4.8 Volt / .70 Ah	5076	\$15.00
Gemini PC-2 Clock (Memory)	3 Volt / .95 Ah	5976	\$9.00
Gemini PC-4 TX (841025) (Requires 2/unit)	6 Volt / 3.4 Ah	5675	\$29.00
IMED Gemini Logic Board PC-1, PC-2, TX, PC-4, 965A (841018)	4.8 Volt / .70 Ah	5602	\$9.50

**ALARIS MEDICAL (CARDINAL HEALTH) ... continued from previous page**

	IMED Gemini PC-1, 1310	6 Volt / 7.2 Ah	5994	\$24.50
	IMED Gemini PC-2, PC2TX, 1320, 1325, 800, 900 Series Infusion Pumps	6 Volt / 12.0 Ah	5614	\$27.00
	IMED Gemini PC-4, PC-4-XL (841030) (Requires 2/unit)	12 Volt / 3.4 Ah	5667	\$41.00
	Medley 8000, 8015, 8100, 8110, 8220, 8300, 8600 Medication Safety System (145997-101)	12 Volt / 4.3 Ah	5073	\$69.50
	Medley 8000, 8100 (Memory)	3.0 V Lithium	5884	\$3.25
	Medley 8000, 8100 (New Revision) (Memory)	3 Volt / .19 Ah	6283	\$9.50
	Med Systems III, 2800, 2860D, 2863B, 9500 (2860729) (Insert Only)	3.6 Volt / 1.7 Ah	5624-I	\$18.75
	Med Systems III, 2800, 2860D, 9500 (2860729) (Send in for Retrofit)	3.6 Volt / 1.7 Ah	5624	\$30.00
	Med Systems III (2860703) (Memory)	3 Volt / 2.5 Ah	5748	\$14.50
	Minimed 404-SP (Requires 3/unit)	1.5 V Alkaline	5625	\$1.60
	Scanner 8015	3 Volt / 1.1 Ah	5828	\$15.00
	Signature 7000, 7100, 7200 E-K Infusion Pumps, 7130, 7130B, 7130D, 7230D Signature Gold Infusion Pump SE (141788)	12 Volt / 1.8 Ah	5860	\$49.00

<b>ALCON LABORATORIES, INC.</b>			
Renaissance Series Autokeratometer (190-009)	6.0 Volt / .27 Ah	6210	\$28.50



<b>AMERICAN DIAGNOSTIC CORP.</b>			
9002/ESPHYG 2	4.8 Volt / 1.65 Ah	6295	\$45.00

<b>AMERICAN SCALE</b>			
700 DOR-3 Scale (NiCd)	9.6 Volt / .65 Ah	5236	\$18.00
700 DR-3 Scale (Alkaline)	12 Volt / 2.5 Ah	5236-A	\$8.00
800 Scale	12 Volt / 2.5 Ah	5515	\$20.00
Kin Air Bed Transport	12 Volt / 33.0 Ah	5395	\$85.00

<b>AMSCO (STERIS)</b>			
C-Max Bed (Requires 2/unit)	12 Volt / 28.0 Ah	5983	\$85.00
Hall Arthroscope	12 Volt / 2.9 Ah	5385	\$29.00
Sterilizer 2047 (Requires 4/unit)	6 Volt / 3.2 Ah	5373	\$22.00
Surgical Table 3080 RC / 3080 RL, 3080SP, 3085 Motor Battery - New Revision (Requires 2/unit)	12 Volt / 28.0 Ah	5850	\$110.00
Surgical Table 3080 RC / 3080 RL, 3080SP, 3085 Motor Battery - Original Battery (Requires 2/unit)	12 Volt / 26.0 Ah	5393	\$67.00
Surgical Table 3080 RC / 3080 SP / 3080 RL / 3085 Control Battery (93908-637) (Requires 2/unit)	12 Volt / 2.8 Ah	5933	\$32.00

<b>AMVEX</b>			
Digital Vacuum Regulator	3.6 Volt / 5.0 Ah	6370	\$23.00

<b>APEX HEALTHCARE</b>			
EPC250 Surgical Chair (Insert) (Requires 4/unit)	12 Volt / 1.3 Ah	5383	\$18.50
ESC Surgical Chair (Insert) (Requires 2/unit)	12 Volt / 1.3 Ah	5383	\$18.50
Stella, 450E, 650 (Insert) (Requires 2/unit)	12 Volt / 5.0 Ah	5388	\$25.00

<b>ARJO HUNTLEIGH</b>			
Alpine 600 (Requires 2/unit)	12 Volt / 7.0 Ah	5390	\$25.00
Bravo Patient Lift (Requires 2/unit)	12 Volt / 7.2 Ah	5780	\$34.00
Chair Lift 29181, 29182, Century Chair Lift (102193)	12 Volt / 7.0 Ah	5390	\$25.00
Flowtron Universal IPC System (BBP600)-Retrofit	13.8 Volt / 4.0 Ah	6455	\$90.00
Maxi Sky 1000 Patient Lift (Requires 2/unit)	12 Volt / 8.5 Ah	5390-F2	\$33.00
Maxi Sky 400 Patient Lift (Requires 2/unit)	12 Volt / 2.5 Ah	5515	\$20.00
Maxi Sky 600 Patient Lift (Requires 2/unit)	12 Volt / 5.0 Ah	5388	\$25.00
Patient Lift Carendo Shower Chair NEA0100-083 (Retrofit)	24 Volt / 3.0 Ah	6293	\$215.00
Patient Lift Encore, Opera, Tempo, Maxi 500 (KPA0100) (OEM)	24 Volt / 5.0 Ah	KPA0100	\$815.00
 Patient Lift Encore, Opera, Tempo, Maxi 500 (KPA0100) (Send in for Retrofit)	24 Volt / 5.0 Ah	5050 C	\$125.00
 Patient Lift (NDA0100-03, 0100-20, MA1100) (Send in for Retrofit)	24 Volt / 3.8 Ah	5050 D	\$85.00
Patient Lift, Trixie (KTA0102) (Send in for Retrofit)	24 Volt / 2.9 Ah	5050 F	\$80.00

**ARJO HUNTLEIGH ... continued from previous page**



Patient Lift with Handle,  
EZ Lift (4 Position Plug)

24 Volt / 5.0 Ah

5050 A

\$66.00



Patient Lift with Handle, EZ Lift,  
Maxi Move (KPA0300)  
(3 Position Plug)

24 Volt / 5.0 Ah

5050 E

\$66.00



Patient Lift with Handle SARA Lift  
(Send in for Retrofit)

24 Volt / 3.8 Ah

5050 B

\$85.00

**ARROW INTERNATIONAL**

Inview 9000 Portable Ultrasound (410057) (Send in for Retrofit)	12 Volt / 4.0 Ah	6348	\$98.00
---	------------------	------	---------

**ARTROMICK**

Acute Cart	12 Volt / 9.0 Ah	1986-F1	\$34.00
Avalo Cart	12 Volt / 13.0 Ah	5722	\$135.00
Medicine Cart	12 Volt / 7.0 Ah	5390	\$25.00
Slimline Cart, E Series Medication Cart, Project 90	12 Volt / 2.3 Ah	5389	\$40.00

**ARVEE MEDICAL**

Apnea Monitor 2400 (Alarm)	3.6 Volt / .06 Ah	5488	\$15.00
----------------------------	-------------------	------	---------

**ASPECT MEDICAL SYSTEMS**

A1000, A1050 Monitor	12 Volt / 7.0 Ah	5390	\$25.00
A2000 Monitor (195-0019)	7.2 Volt / 2.1 Ah	5935	\$45.00

**ASPEN LABS (ZIMMER)**

Arthrotone 5039 02, 06	12 Volt / 2.9 Ah	5385	\$29.00
ATS 1000, 1200, 1500 Tourniquet	12 Volt / 2.5 Ah	5515	\$20.00
ATS 2000 Tourniquet (60-7000-027) (Requires 2/unit)	12 Volt / 2.5 Ah	5515	\$20.00
ATS 3000 Tourniquet	12 Volt / 5.0 Ah	5388	\$25.00
ATS 750 Tourniquet	12 Volt / 1.2 Ah	5838	\$20.00

**ASTRO-MED**

2000 Alpha Stimulator (Requires 6/unit)	6 Volt / 3.0 Ah	5371	\$15.00
---	-----------------	------	---------

**ASTRO-MED ... continued from previous page**

Dash I, II, Mark II Recorder (Requires 2/unit)	12 Volt / 7.0 Ah	5390	\$25.00
NT 9000 (Memory)	4.8 Volt / .11 Ah	5590	\$11.25
Super 8 Recorder (Requires 2/unit)	12 Volt / 7.0 Ah	5390	\$25.00
Z-1000 Graphic Recorder	12 Volt / 7.0 Ah	5390	\$25.00

**ATMOS**

5041 Wound Pump	18 Volt / 2.5 Ah	6359	\$125.00
-----------------	------------------	------	----------

**AUTOGENIC SYSTEMS**

AT 33 (Requires 4/unit)	1.2 Volt / 1.8 Ah	5853	\$4.90
-------------------------	-------------------	------	--------

**AVI (3M HEALTHCARE)**

200 External Feeding Pump (01263 REV. 4)	7.2 Volt / 1.6 Ah	6035	\$30.00
3000 Infusion Pump	12 Volt / 1.3 Ah	5547	\$27.00
7000, 7800 Centrifuge Pump	12 Volt / 12.0 Ah	5820L	\$37.00
Guardian Volumetric Infusion Pump 100, 110, 200, 200A,	12 Volt / 2.5 Ah	5515	\$20.00
Micro 285 Infusion Pump	12 Volt / 2.5 Ah	5515	\$20.00

**A-VOX SYSTEMS**

Avoximeter 1000E (12140S)	4.8 Volt / 1.7 Ah	6060	\$21.00
---------------------------	-------------------	------	---------

**BARDSYSTEMS (DIAGNOSTIC ULTRASOUND, SITE MICRO)**

Harvard PCA Pump	12 Volt / 1.3 Ah	5383	\$18.50
Harvard Syringe Pump (HV-9250-003) (2 Battery Set)	7.2 Volt / 5.0 Ah	6029	\$76.00
Intra-Aortic Balloon Pump H8000 (2 Battery Set)	24 Volt / 7.2 Ah	5839	\$68.00
Micropace EPS320 Stimulator	12 Volt / 2.5 Ah	5515	\$20.00
PCA-1 Pump	12 Volt / 1.3 Ah	5383	\$18.50
Power Pak System, CPS H4305, H4322	12 Volt / 7.0 Ah	5390	\$25.00
Site-Rite 5, Site-Rite 6	11.1 Volt / 7.2 Ah	6181	\$129.00
Site-Rite IV (800049B01) (800113B01) (Send in for Retrofit)	14.4 Volt / 4.5 Ah	5060	\$125.00
Site-Rite IV (800049B01) (Insert)	14.4 Volt / 4.5 Ah	5060-I	\$120.00
Urotrak Urometer 210, 220, 224 (2 Battery Set)	4 Volt / 3.5 Ah	5299	\$50.00
Ventilator 750	12 Volt / 1.3 Ah	5383	\$18.50

**BAXTER (TRAVENOL, SABRATEK, SIGMA)**

6060 Pump (2M9838) (Send in for Retrofit/Exchange)	12 Volt / 1.2 Ah	6207	\$75.00
AP II Pump (Memory)	3 Volt / .225 Ah	5091	\$3.25
AS2, AS5A, AS5B, AS5C, AS5D Auto Syringe	12 Volt / 2.5 Ah	5515	\$20.00
AS2F, AS2FH, AS5B, AS20A, AS20S, AS20-GH Pump	6 Volt / .70 Ah	5149	\$15.00
AS40A, AS50A Syringe Pump (NiCd)	6 Volt / 1.2 Ah	5601	\$25.00



AS40A, AS50A Syringe Pump (NiMH)

AS40A, AS50A Syringe Pump (NiMH)	6 Volt / 2.1 Ah	5601-NiMh	\$30.00
ASAT Pulse Oximeter	8 Volt / 2.5 Ah	5051	\$36.00

**BAXTER (TRAVENOL, SABRATEK, SIGMA) ... continued from previous page**

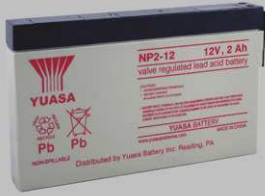

Colleague CX, 3 Channel, Flo-Guard  
6201, 2M8063 Infusion Pump  
(UBAT1010A) (May Require 2/unit)

12 Volt / 2.0 Ah 5778 \$22.00

Colleague Infusion Pump (Memory)	7.2 Volt / 2.1 Ah	5977	\$23.00
Fenwal Autoseal (4R4370)	26.4 Volt / 3.0 Ah	5762-B	\$175.00
Flo-Gard 2000, 2100 Pump (Powersonic)	8 Volt / 3.2 Ah	5536-P	\$25.00
Flo-Gard 2000, 2100 Pump (Sonnenschein)	8 Volt / 2.7 Ah	5536	\$58.50
Flo-Gard 2000 Controller, 2100 Infusion Pump (EnerSys)	8 Volt / 2.5 Ah	5016	\$37.00
Flo-Gard 2M8015, 6000, 6100 Infusion Pump	6 Volt / 12.0 Ah	5614	\$27.00
Flo-Gard 6200, 6600 Infusion Pump (2 Battery Set)	8 Volt / 6 Ah	5157	\$68.00
Flo-Gard 6201, 6300, 6301 (Memory)	3 Volt / 1.1 Ah	5828	\$15.00
Flo-Gard 6201 Infusion Pump	12 Volt / 2.0 Ah	5631	\$22.00



Flo-Gard 6300, 6301 Infusion Pump

12 Volt / 3.4 Ah 5667 \$41.00

Flo-Gard 8000, 8100 Infusion Pump (EnerSys)	8 Volt / 2.5 Ah	5016	\$37.00
Flo-Gard 8000, 8100 Pump (Sonnenschein)	8 Volt / 2.7 Ah	5536	\$58.50
Flo-Gard 8200 Infusion Pump (Sonnenschein)	8 Volt / 2.7 Ah	5712	\$68.50
Flo-Gard 8500 Volumetric Infusion Pump (EnerSys)	8 Volt / 2.5 Ah	5016	\$37.00
Flo-Gard 8500 Volumetric Infusion Pump (Sonnenschein)	8 Volt / 2.7 Ah	5536	\$58.50
Flo-Guard 8000, 8100, 8200, 8500 (Powersonic) Infusion Pump AS6H/AS6C Series	8 Volt / 3.2 Ah	5536-P	\$25.00
Oxysat Meter SM-0200	8.4 Volt / .180 Ah	5398	\$9.45
Pac-xtra APD Cyler, Dialysis Cyler	6 Volt / 4.5 Ah	5374	\$12.00
PCA II (Memory)	12 Volt / 2.4 Ah	5829	\$32.00
PCA-II (Non-Rechargeable) (Requires 2/unit)	3 Volt / .20 Ah	6368	\$12.00
PCA-II (Rechargeable)	Procell D Alkaline	PC1300	\$0.90
	4.8 Volt / 4.5 Ah	5341	\$47.50

**B. BRAUN (MCGAW, AMERICAN EDWARDS LABS)**

Cardiac Output Computer Monitor 9520, 9528 (Requires 3/unit)	6 Volt / 1.0 Ah	5368	\$9.00
--	-----------------	------	--------



Horizon 6000, Classic, NXT Pump  
(F2501305)

12 Volt / 2.0 Ah 5655 \$24.00



**B. BRAUN (MCGAW, AMERICAN EDWARDS LABS) ... continued from previous page**

	Horizon Pump, Outlook 100, 200, 200ES, 300ES, 400ES (127011) (Alarm)	4.8 Volt / .11 Ah	5786	\$18.00
	Horizon Pump, Outlook 100 (435101) (Memory)		5739	\$5.50
	Infusion Pump VIP N7922, N7927	6 Volt / 10.0 Ah	5380	\$18.00
	Intelligent Infusor Pump 2001	6 Volt / 4.5 Ah	5374	\$12.00
	Intelligent Infusor Pump 2001 (Revision A21502-S)	6 Volt / 3.0 Ah	5371	\$15.00
	Intelligent Pump 521, 522 (Factory Upgrade)	12 Volt / 2.0 Ah	5631	\$22.00
	Intelligent Pump 521, 821	6 Volt / 3.0 Ah	5371	\$15.00
	Intelligent Pump 521 Plus, 522	6 Volt / 4.5 Ah	5374	\$12.00
	Kangaroo E Pump (F010484)	4.8 Volt / 3.8 Ah	6094	\$40.00
	Outlook 100, 100ES, 200ES, 300ES, 400ES (Memory) (Blue PCB - Rechargeable)	3 Volt / .17 Ah	6339	\$6.00
	Outlook 100, 100ES, 200ES, 300ES, 400ES (Memory) (Green PCB - Non-Rechargeable)	3 Volt / .28 Ah	6338	\$5.50
	Outlook 100, 200, 620-100, 620-200 Safety Infusion System (Sealed Lead Acid)	12 Volt / 2.2 Ah	5991	\$27.00
	Outlook 100ES, 200ES, 300ES, 400ES, 621-100ES, 621-200ES, 621-300ES, 621-400ES (FZ00435250) (NiMH Version)	12 Volt / 4.3 Ah	6320	\$89.50
	Space Infusion Pump System (8713180)	4.8 Volt / 2.7 Ah	6312-R	\$90.00
	Space Infusion Pump System (8713180) (OEM)	4.8 Volt / 2.1 Ah	6312	\$157.00
	Vista Basic (33175551, 34520556)	7.2 Volt / 1.2 Ah	6084	\$45.00
	Vista Reliance	8.4 Volt / 4.0 Ah	6077	\$85.00

**BEAR MEDICAL SYSTEMS (VIASYS, BIRD)**

Bear 33 Portable Ventilator	12 Volt / 3.4 Ah	5667	\$41.00
Bear II, III, IV, V	4.8 Volt / .70 Ah	5162	\$12.50
Bear I (Requires 8/unit)	1.5 V Alkaline	5407	\$0.45
Cub 750, 750VS Ventilator	12 Volt / 1.3 Ah	5383	\$18.50
Cub BP2001 Ventilator, LS80 Adult/Infant Monitor	4.8 Volt / .70 Ah	5162	\$12.50
Graphic Display 1000 (Memory)	3.6 Volt / .40 Ah	TL5186	\$18.00
Tissue Processor Ultra 2	6 Volt / 3.0 Ah	5371	\$15.00

**BELMONT INSTRUMENT CORP.**

FMS 2000	12 Volt / 1.2 Ah	5838	\$20.00
----------	------------------	------	---------

**BENNETT X-RAY TECHNOLOGIES**

Contour Mammography Unit (Requires 20/unit)	12 Volt / 5.0 Ah	5388	\$25.00
HFQ300SE (Requires 30/unit)	12 Volt / 2.5 Ah	0819-0020	\$40.00
HFQ600SE (Requires 60/unit)	12 Volt / 2.5 Ah	0819-0020	\$40.00

<b>BENNETT X-RAY TECHNOLOGIES ... continued from previous page</b>			
HMX5 (Requires 10/unit)	12 Volt / 33.0 Ah	5395	\$85.00
MF1500 (Requires 24/unit)	12 Volt / 2.5 Ah	0819-0020	\$40.00
MF150 (Requires 20/unit)	12 Volt / 2.5 Ah	0819-0020	\$40.00

<b>BERCHTOLD CORP.</b>			
Operon B810 (Requires 2/unit)	12 Volt / 28.0 Ah	5850	\$110.00

<b>BEST</b>			
Keypad	6 Volt / 2.9 Ah	6219-LI	\$18.50
Keypad	6 Volt / 2.0 Ah	6219	\$12.00

<b>BFW</b>			
Mid 9400 Eco Pack (Send in for Retrofit)	6 Volt / 3.0 Ah	6287	\$40.00

<b>BHM MEDICAL, INC. (ERGOLIFT)</b>			
Voyager (A8500)	24 Volt / 2.3 Ah	6138	\$90.00
Voyager Lift 420, V10, Ergolift 2, 600 (Requires 2/unit)	12 Volt / 7.0 Ah	5390	\$25.00
Voyager Lift 4V, 4Vi, Ergostand, Graduate, Junior, Medi-SSL2, MediLifter 4, Ministand (Requires 2/unit)	12 Volt / 5.0 Ah	5388	\$25.00
Voyager Lift V3 (Requires 2/unit)	12 Volt / 2.5 Ah	5515	\$20.00

<b>BIOCHEM, BCI (NONIN MEDICAL)</b>			
3045, 67100, 8604P Printer	6 Volt / 1.2 Ah	5369	\$10.00
515 Respiration Monitor, MUI 5000	6 Volt / 1.2 Ah	5369	\$10.00
525 Respiration Monitor	6 Volt / 3.4 Ah	5675	\$29.00
6200	12 Volt / 2.9 Ah	5969	\$38.00
700, 6100, 58200A Monitor	12 Volt / 7.0 Ah	5390	\$25.00
7500 Pulse Oximeter (4032-0003)	7.2 Volt / 1.65 Ah	6329	\$65.00
80040 Surgivet Monitor 6004	6 Volt / 3.0 Ah	5945	\$50.00
8500 Pulse Oximeter (Requires 6/unit)	1.2 Volt / 2.1 Ah	5397-NiMh	\$3.00
8600, 8604, 8604D, 8604F Pulse Oximeter	6 Volt / 1.8 Ah	5353	\$37.00
9400 Patient Monitor	6 Volt / 4.4 Ah	5108	\$45.00
Auto-coor ECG SPO2	6 Volt / 1.3 Ah	5469	\$14.00



Avant 2120, 4000, 9600, 9700 Pulse Oximeter, Autocorr (4032-001) 7.2 Volt / 4.0 Ah 6037 \$55.00

BCI 3202, 3302, 3304 Pulse Oximeter	6 Volt / 1.3 Ah	5852	\$13.57
BCI Mini-Toor Plus, NIBP Monitor 6004 (58480A6, 58522B2)	6 Volt / 3.0 Ah	5945	\$50.00
BIC Mini-Toor Plus, NIBP Monitor 6004 (Memory)	3 Volt / .255 Ah	6033	\$6.00



**BIOCHEM, BCI (NONIN MEDICAL) ... continued from previous page**

Capnocheck CO2, SPO2, 3303,  
AD700, 8200 (9714)  
(AAPLQBC1108)

9.6 Volt / 1.6 Ah 5903 \$57.00

Capnocheck ET CO2 Monitor	6 Volt / 4.5 Ah	5078	\$16.00
Capnocheck II, 8400, 8401 Capnograph Pulse Oximeter (Li-Ion)	7.4 Volt / 2.4 Ah	6082	\$72.00
Capnocheck Plus, Sleep CO2 Monitor (58522B1)	6 Volt / 4.4 Ah	5108	\$45.00
Capnometer 9090	3.6 Volt / .10 Ah	5840	\$15.00
Microspan 1040, 8700, 8800 Pulse Oximeter	6 Volt / 1.8 Ah	5353	\$37.00
Microspan 3040, 3040G, 3100 Pulse Oximeter	6 Volt / 1.2 Ah	5369	\$10.00
PalmSat 2500, 2500A Pulse Oximeter (3088-000)	4.8 Volt / 1.6 Ah	6088	\$30.00
Pulse Oximeter ECG Monitor, 100, 3101 (Requires 2/unit)	6 Volt / 4.5 Ah	5374	\$12.00

**BIODEX MEDICAL SYSTEMS, INC.**

Deluxe C-ARM Table (056-004) (Requires 2/unit)	12 Volt / 26.0 Ah	5393	\$67.00
Urology Table (005-450) (Requires 2/unit)	12 Volt / 26.0 Ah	5648	\$67.00

**BIOHIT**

eline Pipette (731001) (Insert Only) (Save plastic case)	4.8 Volt / .50 Ah	6403	\$18.50
Proline Epet Pipette (711002)	6 Volt / .15 Ah	6080	\$11.50

**BIO LOGIC DEVICES (AXON, CAS MEDICAL)**

Analyzer RF303	12 Volt / 2.5 Ah	5515	\$20.00
Audx 5800	7.2 Volt / 1.2 Ah	5971	\$35.00
Bio-Feedback Oscillomate 820, PPM 930	6 Volt / 1.2 Ah	5369	\$10.00
Sleepscan Traveler (Send in for Retrofit)	6 Volt / 4.0 Ah	6025	\$40.00

**BIOMEDICAL DESIGN INSTRUMENTS**

Electro Accu Scope EAS-70, 80	32 Volt / 5.0 Ah	5310	\$190.00
Electro-Accu Scope EAS-70C	24 Volt / .70 Ah	5086	\$65.00
Electro-Accu Scope EAS-85P (Requires 2/unit)	12 Volt / 1.3 Ah	5383	\$18.50
Myo Pulse Nerve Stimulator	32 Volt / 5.0 Ah	5713	\$192.00

**BIO-MEDICAL DEVICES**

Crossvent 2i+	7.2 Volt / 4.6 Ah	6064-NiMH	\$50.00
Crossvent 2i (PRT4402)	7.2 Volt / 3.0 Ah	6064	\$40.00
Crossvent 3, 3+, 4, 4+ (NiCd - 2 wire)	7.2 Volt / 5.0 Ah	5960	\$65.00
Crossvent 3+, 4+ (PRT4467) (NiMH - 3 wire)	7.2 Volt / 10.0 Ah	5960-NiMH	\$150.00
M10 Ventilator Monitor (Save Original Wire Harness)	7.2 Volt / .85 Ah	5564	\$34.50

**BIONET**

CardioCare 2000, CardioTouch 3000 (GP130AAM20YMXZ)	12 Volt / 2.6 Ah	6168	\$80.00
--	------------------	------	---------

**BIO-TEK INSTRUMENTS**

Index 2F2	12 Volt / 2.0 Ah	5992	\$55.00
-----------	------------------	------	---------



**BULLARD**

PA20 Respirator (84932)	9.6 Volt / 4.0 Ah	6439	\$95.00
-------------------------	-------------------	------	---------

**BURDICK (QUINTON, SIEMENS, SPACELABS)**



Atria 3000, 3100, 6000, 6100, 8300,  
8500, (92700) (146-0126-00,  
146-0127-00) (146-0131-00)

14.4 Volt / 1.6 Ah 6053 \$45.00

Atria 3100 (146-0131-00) Send in for retrofit	14.4 Volt / 1.5 Ah	6452	\$45.00
Cardiograph Stat 1	6 Volt / 3.2 Ah	5373	\$22.00
Cardiovive AED 92533 (01-1668-00) (OEM)	12 Volt / 7.5 Ah	6063	\$345.00
E350I, E550, E560, M330 (Memory)	3 Volt / 1.2 Ah	5062	\$5.00
E500, E500C, E500TW, E600 (850568) (Memory)	3 Volt / 1.3 Ah	5644	\$9.00
E500, E600 Monitor Main Power (862573)	9.6 Volt / .65 Ah	5565	\$22.00
E550 EKG Monitor Main Power	12 Volt / 2.8 Ah	5424	\$33.00
E560 EKG Monitor Main Power	24 Volt / 1.3 Ah	5719	\$60.00
Eclipse 4, 4i, 850, E350, LE II EKG, Premier Eclipse Plus (146-0022-00) (Memory)	3.0 V Lithium	5765	\$4.25
Eclipse 4, 4i EKG, 400, 850, LE, LE II (92304) (862-988) (863696)	16.8 Volt / .70 Ah	5834	\$50.00
 Eclipse 8, 8I, 800 (863-045)	16.8 Volt / 1.8 Ah	5876	\$95.00
Eclipse Plus (850-794)	16.8 Volt / 2.3 Ah	5891	\$107.00
Eclipse Plus (92301) (146-0100-00) (Premier Upgrade) (Large)	16.8 Volt / 4.4 Ah	5003	\$149.00
EK10 - Elite, Elite II (862278)	12 Volt / 1.8 Ah	5226	\$37.00
EK10 - Elite, Elite II, Eclipse LE (Memory)	3 Volt / 1.2 Ah	5062	\$5.00
Medic 3 Monitor Defibrillator	24 Volt / 2.4 Ah	5204	\$127.00
Medic 4 Monitor Defibrillator	24 Volt / 2.5 Ah	5215	\$117.70
Medic 5 Monitor Defibrillator (850596)	24 Volt / 2.0 Ah	5717	\$60.00
Medic 6 Monitor Defibrillator (Send in for Retrofit)	12 Volt / 1.8 Ah	5944	\$95.00
Medi Log 6000 Arrythmia	1.5 V Alkaline	5407	\$0.45
Presto Slash Spirometer	6 Volt / 2.5 Ah	5223	\$20.00
Quest Stress (Memory)	3.0 V Lithium	5884	\$3.25
SE-1200 Express EKG (TWSLB-004) (OEM)	14.8 Volt / 4.4 Ah	6418	\$435.00
Spirotouch (882192)	6 Volt / 8.0 Ah	5958	\$80.00

**CAMBRIDGE INSTRUMENTS (AMERICAN OPTICAL & PICKER INT'L)**

700I Electrocardiogram	12 Volt / 2.9 Ah	5573	\$38.00
A05 Patient Mobilizer (Requires 2/unit)	12 Volt / 26.0 Ah	5392	\$67.00
Collimatic IV Electronic (Memory)	2.4 Volt / .06 Ah	5842	\$12.00
Eclipse 4I ECG	16.8 Volt / .70 Ah	5834	\$50.00
Explorer Mobile X-Ray (Driveside)	12 Volt / 26.0 Ah	5393	\$67.00
Model 502	6 Volt / 4.5 Ah	5374	\$12.00
Picker Dynamore Gama Camera	12 Volt / 26.0 Ah	5392	\$67.00
SC1000 Single Channel ECG (Requires 8/unit)	1.2 Volt / .70 Ah	5397	\$2.65
Telemed Omnigraph 6000 3 Channel EKG (Requires 2/unit)	12 Volt / 2.9 Ah	5573	\$38.00

MEDICAL BATTERIES MFG/MODEL VOLTAGE/CAPACITY R&D PART LIST PRICE

### CAMINO LABORATORIES

412, 420, 420-6 Intercranial Pressure Monitor	12 Volt / 1.2 Ah	5838	\$20.00
MPM 1-6, MPM-1	12 Volt / 2.0 Ah	5631	\$22.00

### CAMTEC

Care Chair	12 Volt / 7.0 Ah	5390	\$25.00
------------	------------------	------	---------

### CARAPACE

190 Cast Cutting Saw	26.4 Volt / .65 Ah	5858	\$65.00
----------------------	--------------------	------	---------

### CARDIAC SCIENCE (SURVIVALINK)

AED, G3, 9142, 9143, 9146-202, 9146-302, 9300E (with nub)	12 Volt / 7.5 Ah	6063-A	\$225.00
First Responder 9001, 9004	12 Volt / 2.3 Ah	5389	\$40.00
Powerheart AED, Caridac Science 9141	12 Volt / 7.5 Ah	6062-A	\$245.00



PowerHeart AED G3, 9142, 9143,  
9146, 9146-102, 9146-202,  
9146-302 9300E (With Nub)  
(OEM)

12 Volt / 7.5 Ah	9146-202	\$345.00
------------------	----------	----------

PowerHeart AED G3, 9142, 9143, 9146, 9146-102, 9146-202, 9146-302 9300E (With Nub) (OEM)	12 Volt / 7.5 Ah	6063	\$345.00
--	------------------	------	----------

### CARDIO DYNAMICS

Bioz 4110-121 (OXACRDY10-BQ) (Rev. B) (Clock)	3 V Lithium Coin	CR2335	\$3.25
Bioz 4110-121 (OXACRDY10-BQ) (Rev. B) (Send in for Retrofit)	12 Volt / 2.7 Ah	6074	\$145.00
Bioz Impedence Meter BZ4110-101 (NJ1020)	12 Volt / 3.8 Ah	5963	\$199.00

### CARDIOLINE (REMCO)

AR1200 ECG	12 Volt / 1.6 Ah	6113	\$42.00
AR2100 ECG	12 Volt / 2.5 Ah	5515	\$20.00
AR600 ECG	9.6 Volt / 1.6 Ah	6112	\$40.00
Delta 1 Plus, Delta 3 Plus (1220211-01)	24 Volt / .70 Ah	5932	\$48.00
Delta 60 Plus	24 Volt / 1.8 Ah	5979	\$75.00
EP700 EKG	18 Volt / .70 Ah	6350	\$65.00
Recorder-E-1, E3 ECG (Rechargeable) (Requires 8/unit)	1.2 Volt / 2.3 Ah	5403	\$6.85

### CARDIOVIVE

AED G3, 9142, 9143, 9146, 9300E (with Nub) (OEM)	12 Volt / 7.5 Ah	9146-202	\$345.00
--	------------------	----------	----------

### CAREFUSION

Aveo Ventilator 68339A	24 Volt / 4.5 Ah	6068	\$225.00
LTV1150, LTV1200 Sprint Pack Battery (19444-001) (OEM)	14.4 Volt / 6.6 Ah	6451	\$392.00
NOX-T3 Portable Sleep Monitor	1.2 Volt / 2.1 Ah	5397-NiMh	\$3.00
Viasys Health Care Spiromat (806525) (OEM)	No Longer Available	6436	\$120.00

### CAS MEDICAL SYSTEMS (BIO LOGIC DEVICES)

511 Monitor	6 Volt / 7.0 Ah	5375	\$18.00
AMI Apnea Monitor (Send in for Retrofit/Exchange)	4.8 Volt / 1.8 Ah	5930	\$45.00
Blood Pressure Monitor 820, 901, 915, 920, 930N, 2001	6 Volt / 1.2 Ah	5369	\$10.00

**CAS MEDICAL SYSTEMS (BIO LOGIC DEVICES) ... continued from previous page**

Blood Pressure Monitor 9000 (White Plug)	6 Volt / 4.5 Ah	5881	\$16.00
Blood Pressure Monitor 9200 (Orange Plug)	6 Volt / 4.5 Ah	5881-A	\$16.00
 NIBP 730, 740, 750 Monitor, 940X Series (03-08-0450) (Insert)	7.2 Volt / 4.0 Ah	6036	\$55.00
NIBP 9001, 9002, 9301, 9303 (01020076) (27761)	6 Volt / 3.2 Ah	5373	\$22.00
NIBP 9300	6 Volt / .65 Ah	5791	\$18.00

**CASTLE STERILIZER (SHAMPAINE)**

3322, 3433, 3500, 3522, 3600 Sterilizer	8 Volt / 2.5 Ah	5680	\$30.00
4900, 4900E (Requires 2/unit)	12 Volt / 5.0 Ah	5388	\$25.00
Data Logger	7.2 Volt / .180 Ah	5399	\$9.45
Message Center (Memory)	3.6 Volt / .11 Ah	5449	\$11.25
Surgical Table 4900B, 5100B (Requires 2/unit)	12 Volt / 26.0 Ah	5393	\$67.00

**CDX**

Spirolab II	7.2 Volt / 4.5 Ah	6052	\$60.00
-------------	-------------------	------	---------

**CENTRON TECHNOLOGIES CORP.**

Blood Collection Mixer	12 Volt / 2.4 Ah	6317	\$115.00
Blood Collection Mixer (BN122) - Retrofit	12 Volt / 3.0 Ah	6364	\$110.00

**CHATTANOOGA GROUP**

Intellect Transport 2738 (Send in for retrofit)	24 Volt / 1.5 Ah	6446	\$85.00
Opti Flex CPM unit, Hand control, Cmos	3 Volt / .165 Ah	5483	\$3.90
Vectra Genisys 2759, 2782 Ultrasonic Therapy Unit (AASCHAT20127478) (Retrofit)	24 Volt / 1.6 Ah	6171	\$105.00

**CLINICAL DYNAMICS**

Smartarm GX-2 (AA Pack)	19.2 Volt / 2.5 Ah	6092	\$78.00
Smartarm GX-2 NIBP Analyzer (55-100A) (460005-078) (NiMH)	19.2 Volt / 2.1 Ah	5848-NiMH	\$145.00
Smart Stat SS-100A	19.2 Volt / 1.25 Ah	5848	\$78.00

**COBE CARDIOVASCULAR (SORIN)**

SIII Base (Requires multiple per unit)	12 Volt / 17.0 Ah	6081	\$74.75
--	-------------------	------	---------

**COLIN MEDICAL INSTRUMENTS (OMRON)**

Advantage, Press-Mate NXT, ASM 5000	12 Volt / 2.0 Ah	5771	\$42.00
BP-88NXT Vital Signs Monitor			
BP-S510 (510-BAT) Patient Monitor	12 Volt / 3.8 Ah	5963	\$199.00
Collimatic IV, BP8800 (Memory)	2.4 Volt / .06 Ah	5842	\$12.00
HBT-T105	12 Volt / 3.2 Ah	5679	\$36.75
PB88 Auxiliary	12 Volt / 7.2 Ah	5780	\$34.00
Press-Mate BP8800, 8800C, 8800MSP Monitor	12 Volt / 2.5 Ah	5515	\$20.00
Press-Mate Pal 3110, 3110P (BX-10BAT) (Insert)	12 Volt / 4.5 Ah	6072-I	\$120.00





**CRITICARE SYSTEMS, INC. ... continued from previous page**



Poet Plus 8100 (83278B001) \*Short Version\* 5.65" (Requires 2/unit)

12 Volt / 2.0 Ah 5771 \$42.00

\* May use either Short or Long Version\*



Poet Plus 8100 \*Long Version\* 7.17" (Requires 2/unit)

12 Volt / 2.3 Ah 5389 \$40.00

Poet TE Plus Oximeter, 602-11, 602-13	12 Volt / 2.5 Ah	5515	\$20.00
Pulse Oximeter 500	12 Volt / 1.3 Ah	5383	\$18.50
Pulse Oximeter 501	4.8 Volt / .70 Ah	5250	\$18.00
Pulse Oximeter 502, 504, 504US, 50245, 50445, 506, DXN	6 Volt / 4.5 Ah	5374	\$12.00
Pulse Oximeter 503, 503SP02T, 1040, 5040, Poni	6 Volt / 1.2 Ah	5369	\$10.00
Pulse Oximeter 503S	6 Volt / 1.2 Ah	5746	\$18.00
Pulse Oximeter 504DX	6 Volt / 3.2 Ah	5373	\$22.00
Pulse Oximeter 506NT3, VSM 506 Series	6 Volt / 7.0 Ah	5375	\$18.00
Pulse Oximeter 600, 601, 602, 602-1, 602-2, 602-3	12 Volt / 3.4 Ah	5384	\$25.00
Pulse Oximeter END/TLCO2	12 Volt / 3.4 Ah	5384	\$25.00
Vital Signs Monitor 503, 507, 1100	12 Volt / 3.4 Ah	5384	\$25.00
Vital Signs Monitor 507S	12 Volt / 3.8 Ah	5993	\$32.00
VSM 5070P, 507P, 507ER, 507N, 507E, Scholar II, III, EL	12 Volt / 2.5 Ah	5515	\$20.00

**CRITIKON (GE, SENSOR MEDICS)**



8100, 8100T, 8110, 8120, XL 9300, 9340, 9350, 9400, 9500XL

12 Volt / 2.8 Ah 5119 \$30.00

Cardiac Output 7300, 7350	12 Volt / 7.0 Ah	5390	\$25.00
Care Scape V100 (633178CR)	6 Volt / 3.0 Ah	5371	\$15.00
Compact T (Memory)	3.6 Volt / .15 Ah	5457	\$10.00
Dinamap 8100, 8100T, 8110, 8120	12 Volt / 2.8 Ah	5119	\$30.00
Dinamap Vital Signs 1846, 1846P, 1846SX, 1846SXP	3.6 Volt / 1.2 Ah	5466	\$9.00
Dinamap XL 9300, 9340, 9350, 9400, 9500XL	12 Volt / 2.8 Ah	5119	\$30.00
IV Pump 6695	6 Volt / 10.0 Ah	5380	\$18.00



MPS Portable (633153) (OEM)

12 Volt / 4.0 Ah 6117 \$275.00

Oxycheck Oxygen Monitor (Requires 6/unit)	1.5 V C Alkaline	5406	\$0.65
Oxytrack 8280	3.6 Volt / 1.2 Ah	5466	\$9.00

**CRITIKON (GE, SENSOR MEDICS) ... continued from previous page**

P81T Printer	4.8 Volt / .70 Ah	5872	\$14.00
 Pro 1000, 1100, DP1000 Vital Signs Monitor (633177) (MS633177C) (Insert Only)	12 Volt / 8.0 Ah	5106-I	\$195.00
Pro 1000, 1100, DP1000 VSM (633177) (Send in for Retrofit)	12 Volt / 8.0 Ah	5106	\$195.00
Pro 1000, 1100 VSM (Memory)	3.6 Volt / .15 Ah	5457	\$10.00
Pro 100, 200, 300, 400 (Memory)	3.6 Volt / .15 Ah	5457	\$10.00
 Pro 100, 200, 300, 400, V2 Compact BP, T, TS Monitor (633132) Dinamap Plus 8700, 8710, 8720, 8725, 9700, 9710, 9720, VSM Plus (Requires 2/unit)	12 Volt / 2.3 Ah	5389	\$40.00
Procure NIBP100, 200, 300, 400 Series (Memory)	3.6 Volt / .15 Ah	5457	\$10.00
 Procure NIBP100, 300, 320, 400, 420 Series, V100 (GH633) (633178) Care Scape V100 (633178CR), DPC400N	6 Volt / 3.0 Ah	5371	\$15.00
Procure NIBP200 Series (Yuasa Only)	6 Volt / 3.0 Ah	NP3-6	\$15.00
Pulse Oximeter 503, 504	6 Volt / 1.2 Ah	5369	\$10.00
Real Time (Clock)	3.6 Volt / 1.2 Ah	5466	\$9.00
Simplicity Volumetric Infusion 2100	6 Volt / 10.0 Ah	5380	\$18.00
Vitanet Bedside Unit 1000, 2000, 2200	12 Volt / 1.3 Ah	5383	\$18.50

**CU MEDICAL SYSTEMS**

i-Pad NF1200 AED (NF-OA03) (OEM)	12 Volt / 4.2 Ah	6337	\$154.00
----------------------------------	------------------	------	----------

**CURLIN MEDICAL**

4000 CMS Infusion Pump	6 Volt / 2.7 Ah	6208	\$40.00
BT2 (Memory)	3.6 Volt / .15 Ah	6050-B	\$6.00

**CYBEX**

600C	6 Volt / 2.5 Ah	5223	\$20.00
Biofeedback 303 EMGP (Requires 2/unit)	1.2 Volt / 2.4 Ah	5404	\$6.85
Diagnostic Equipment 6000 Dynamometer (Requires 2/unit)	12 Volt / 7.0 Ah	5390	\$25.00
ELD 320 Electronic Digital Inclinator	7.2 Volt / .70 Ah	5332	\$30.00

**DATASCOPE / MINDRAY**

2100, 2200 NIBP (Memory)	3.6 Volt / .11 Ah	5449	\$11.25
Accustat Pulse Oximeter	12 Volt / 2.5 Ah	5515	\$20.00
Accutorr 1A, 2A (Memory)	3.6 Volt / .06 Ah	5488	\$15.00



**DATASCOPE / MINDRAY ... continued from previous page**



Accutorr 3, 3SAT, 4, 4SAT, BP Monitor (0997-00-0262)

12 Volt / 2.2 Ah

5298

\$30.80



Accutorr Plus, Accutorr V Trio, DPM3, Passport 2 (0146-00-0069, 0146-00-0099, 115-018015-00) (OEM)

11.1 Volt / 4.4 Ah

6132

\$246.00



Accutorr Plus, Spectrum, Trio (0146-00-0043)

12 Volt / 2.3 Ah

5389

\$40.00

Anestar	12 Volt / 7.0 Ah	5390	\$25.00
CS100, CS300 Balloon Pump (0146-00-0039) (Requires 2/unit)	12 Volt / 18.0 Ah	5391	\$65.00
Datascope 3000	24 Volt / 2.3 Ah	5430	\$40.00
Duo (0146-00-0079) (OEM)	7.2 Volt / 6.6 Ah	6228	\$183.86
Intra-Aorta Balloon Pump 90 (Requires 2/unit)	12 Volt / 26.0 Ah	5394	\$67.00
Intra-Aorta Balloon Pump 90T (0146-00-0039) (Requires 2/unit)	12 Volt / 18.0 Ah	5391	\$65.00
Intra-Aorta Balloon Pump 90 (Upgrade) (Requires 2/unit)	12 Volt / 40.0 Ah	5545	\$125.00
Intra-Aorta Pump System 95, 97, 97E, 98, 100 (Requires 2/unit)	12 Volt / 18.0 Ah	5391	\$65.00
M/D3, M/D3A, 693 (Insert)	14.4 Volt / 1.8 Ah	5020-I	\$140.00
M/D3, M/D3A, 693 (Send in for Retrofit)	14.4 Volt / 1.8 Ah	5020	\$140.00
MR Monitor	9 Volt / 1.2 Ah	5868	\$5.95
Passport 2 (Memory)	3.0 V Lithium	5884	\$3.25
Passport Defibrillator DPD (0146-00-0049) (Retrofit/Exchange)	12 Volt / 1.8 Ah	5715	\$95.00
Passport Monitor, Passport EL, XG, 2, 2LT (0146-00-0043)Spectrum, Spectrum OR, Trio, 5L (Requires 2/unit)	12 Volt / 2.3 Ah	5389	\$40.00
Passport Monitor, Passport EL, XG, 2, 2LT (0146-00-0043)Spectrum, Spectrum OR, Trio (Memory)	3 Volt / .16 Ah	BR2325	\$2.50
Passport Monitor, Passport EL, XG (Requires 2/unit)	12 Volt / 2.45 Ah	5389-NiMH	\$90.00
PM-8000 Express, PM-9000 Patient Monitor (M05-0100001-06) (Li-Ion) (OEM)	11.1 Volt / 4.4 Ah	6277	\$246.00
PM-8000 Express, PM-9000 Patient Monitor (SLA)	12 Volt / 2.3 Ah	5389	\$40.00
VS-800 Vital Signs Monitor (M05-0100001-06) (Li-Ion) (OEM)	11.1 Volt / 4.4 Ah	6277	\$246.00
VS-800 Vital Signs Monitor (M05-0100001-06) (SLA)	12 Volt / 2.3 Ah	5389	\$40.00

**DATEX-OHMEDA (OHMEDA)**



ADU Plus

12 Volt / 2.0 Ah

5992

\$55.00

**DATEX-OHMEDA (OHMEDA) ... continued from previous page**

	Aestiva/5 (1503-3045-000 REV. D)	12 Volt / 2.2 Ah	5899	\$35.00
	AS-3 Anesthesia (Requires 4/unit)	12 Volt / 2.5 Ah	5515	\$20.00
	AS/3, AS5, LM, LM1, LMP1 Light Monitor (896895-HEL) (OEM)	13.2 Volt / 1.8 Ah	5906	\$525.00
	AS-3 Monitor Compact Option (017007) (MNC784623P) (17007-HEL)	24 Volt / 1.4 Ah	5833	\$154.00
	AS-3 Monitor Power Supply (017006)	6 Volt / 1.2 Ah	5369	\$10.00
	AS3/S5 SRAM, 197230 (M4T28-BR12SH1)	2.8 V Timekeeper	6315	\$15.00
	Aspire 7900 Vent	12 Volt / 4.0 Ah	5417	\$25.00
	Cardio Cap 5 Monitor (17013)	12 Volt / 2.6 Ah	5082	\$34.00
	EXCEL 210	8.4 Volt / .180 Ah	5398	\$9.45
	F, FM Monitor	11.1 Volt / 4.2 Ah	6253	\$250.00
	Normo Cap 2000, Carbon Dioxide Monitor	6 Volt / 3.0 Ah	5371	\$15.00
	RGM Monitor 5250	3.0 V Lithium	5765	\$4.25
	S/5 Anesthesia Machine (Requires 2/unit)	12 Volt / 5.0 Ah	5388	\$25.00
	S/5 Patient Monitor (17014) (2 Battery Set)	24 Volt / 4.0 Ah	5010	\$225.00
	Satlite OSP-200 (Requires 2/unit)	6 Volt / 3.4 Ah	5675	\$29.00
	TruStat Pulse Oximeter (6050-0006-578 REV. J)	4.8 Volt / 3.2 Ah	6125	\$85.00

**DAVICON**

	Medac System 3000 Biofeedback (Requires 2/unit)	8 Volt / 3.5 Ah	5382	\$49.00
--	---	-----------------	------	---------

**DEFIBTECH**

	Lifeline AED (9 Volt Lithium, for self Checks)	9 Volt / 1.2 Ah	5868	\$5.95
--	--	-----------------	------	--------

**DEFIBTECH ... continued from previous page**



Lifeline AED DCF-100, DCF-110,  
DDU-100  
(DCF-200, DBP-1400) (OEM)

15 Volt / 1.4 Ah 6108 \$149.00

Lifeline DCF-210, DDU-100A AED  
(DCF-210, includes DPB-2800, DAC-410) (OEM)

15 Volt / 2.8 Ah 6405 \$199.00

Lifeline Reviver View AED (DF-2003) (OEM)

12 Volt / 2.8 Ah 6352 \$182.00

**DELMAR MEDICAL SYSTEMS**

Aria Impresario Holter Recorder

3 Volt / .225 Ah 5091 \$3.25

**DELPHI MEDICAL**

Portable Tourniquet System (4-2100-017)

4.8 Volt / 1.8 Ah 6096 \$24.00

**DEPUY**

Pro Flat Tourniquet Regulator (6676-05-000) (Send in for Retrofit)

12 Volt / 1.8 Ah 6129 \$65.00

**DETECTO SCALE**

CN-20L (Requires 4/unit)

1.2 Volt / 4.3 Ah 5703 \$7.25

IB400, 6475, 6800, 8430B Digital Scale

12 Volt / 1.8 Ah 5438 \$51.00

**DEVILBISS (PULSAIR, SUNRISE MEDICAL)**

7304S

12 Volt / 1.3 Ah 5383 \$18.50

7310P Suction Pump (OEM)

12 Volt / 1.65 Ah 6316 \$145.00

LCSU, 7305 P-413, 7305P-614

12 Volt / 2.5 Ah 5975 \$54.00

Nebulizer 5000

12 Volt / 1.3 Ah 5547 \$27.00

OMS 50, Victor VOC 500 Pulse Dose System

6 Volt / .225 Ah 5823 \$33.00

Pulmo-Aid Traveler 6610D

12 Volt / 3.4 Ah 5384 \$25.00

Vac-U-Aide 7304A, 7304D

12 Volt / 1.2 Ah 5533 \$25.00

**DIGITRON (S.R. INSTRUMENTS)**

Baby Scale

6 Volt / 3.0 Ah 5371 \$15.00

Baby Scale 210, 600

6 Volt / 2.5 Ah 5409 \$22.00

Baby Scale D-200, D-210, DW172

8 Volt / 2.5 Ah 5051 \$36.00

Electronic Scale 610, 5000, D8000 Series

6 Volt / 2.8 Ah 5370 \$15.00

Electronic Scale DW200

8 Volt / 2.5 Ah 5381 \$33.00

**DOLPHIN MEDICAL**

2100 Pulse Oximeter

12 Volt / 2.2 Ah 5991 \$27.00

2150 Pulse Oximeter

4.8 Volt / 1.6 Ah 6015 \$20.00

**DRAEGER (NARCO, SIEMENS)**

Apollo (8603057) (2 Battery Set)

24 Volt / 17.0 Ah 6172 \$149.00

Baby Log 8000

8.4 Volt / .180 Ah 5398 \$9.45

Babylog VN500 Ventilator (8415290-08) (Send in for retrofit)

24 Volt / 3.0 Ah 6447 \$175.00

CPU Board (Memory)

3 Volt / 1.5 Ah CR12600SE \$6.00

Desflurane Vaporizer (M35526)

6 Volt / .51 Ah 6179 \$30.00

Evita Dura Ventilator (External)

12 Volt / 33.0 Ah 5395 \$85.00

**DRAEGER (NARCO, SIEMENS) ... continued from previous page**

Evita (Memory)	3.6 Volt / .17 Ah	TL5135	\$15.00
Evita, Savina XL, 2, 4 Ventilator (Internal) (Panasonic) (2/unit)	12 Volt / 3.4 Ah	5667	\$41.00
Evita, Savina XL, 2, 4 Ventilator (Internal) (Sonnenschein) (2/unit)	12 Volt / 3.5 Ah	5972	\$80.00
Evita, Savina XL, Dura Ventilator (1843303) (External)	12 Volt / 17.0 Ah	6081	\$74.75
Evita XL (Memory)	3 Volt / 1.5 Ah	CR12600SE	\$6.00
Fabius, Fabius GS	12 Volt / 3.4 Ah	5667	\$41.00
 Infinity Delta, Delta XL, Infinity Gamma XL, Gamma, Vista (MS14234, MS14490) (Internal) (Li-Ion)	14.4 Volt / 4.4 Ah	6059	\$179.00
 Infinity Delta X, XL, Vista Monitor (External)	12 Volt / 2.3 Ah	5389	\$40.00
Infinity Gama XL (External)	12 Volt / 2.0 Ah	5771	\$42.00
Isolette TI500	12 Volt / 26.0 Ah	5393	\$67.00
Julian (Requires 2/unit)	12 Volt / 8.5 Ah	5390-F2	\$33.00
MRI	12 Volt / 18.0 Ah	5391	\$65.00
Narkomed 6000 (Requires 4/unit)	12 Volt / 28.0 Ah	5850	\$110.00
Narkomed Anesthesia 2A	12 Volt / 7.0 Ah	5505	\$28.00
Narkomed Anesthesia 2B (4106093) (Save Original Wire Harness)	12 Volt / 7.0 Ah	5390	\$25.00
Narkomed Anesthesia 2C	12 Volt / 18.0 Ah	5391	\$65.00
Narkomed Anesthesia 2C (Memory)	3 Volt / .95 Ah	1000-0	\$18.00
Narkomed Anesthesia 3B, Cart 3 (Requires 2/unit)	12 Volt / 7.0 Ah	5390	\$25.00
Narkomed Anesthesia 4 (Requires 4/unit)	12 Volt / 7.0 Ah	5390	\$25.00
Narkomed GS	12 Volt / 7.0 Ah	5390	\$25.00
Narkomed GS Anesthesia (Memory)	3 Volt / .165 Ah	5483	\$3.90
Oxylog 2000 Ventilator (8411599-05) (Insert)	7.2 Volt / 1.6 Ah	5938-I	\$35.00
Oxylog 2000 Ventilator (8411599-05) (Send in for Retrofit)	7.2 Volt / 1.6 Ah	5938	\$35.00
Oxylog 3000 Ventilator (Li-Ion)	11.1 Volt / 7.2 Ah	6181	\$129.00
SC700 Monitor (Memory)	3 Volt / .560 Ah	6313	\$4.25
Telemetry Transmitter	9 Volt / 1.2 Ah	5868	\$5.95
V1000, V2000 Vitalert Anesthesia Monitor	18 Volt / 3.4 Ah	5490	\$68.00
Vamos Anesthetic Gas Monitor (Li-Ion)	11.1 Volt / 7.2 Ah	6181	\$129.00

**DUKANE**

2070, 4000 Nurse Call	6 Volt / 1.0 Ah	5368	\$9.00
Master Clock	6 Volt / 1.2 Ah	5369	\$10.00
Nurse Call Locator Badge	3 Volt / .95 Ah	CR2477N	\$4.25

**DYNATECH NEVADA (TRIMED, QUEST MEDICAL)**

Defibrillator Tester 4000	12 Volt / 2.5 Ah	5386	\$20.00
Med Tester 5000	3 Volt / 1.5 Ah	5605	\$9.00
Oxitest 2000, Oxitest 7 Plus (3310-003)	7.2 Volt / 1.4 Ah	5203	\$27.00

**DYNEX**

Neuro Stimulator 2000, 2005, 2013, Dynex II Pressure Contact Version (Insert)	4.8 Volt / .15 Ah	5345-A	\$18.00
Solder Tab Version (Insert)	4.8 Volt / .15 Ah	5345-B	\$18.00

<b>DYONICS</b>			
Arthroscopic Surgical Power Unit 30	6 Volt / 3.0 Ah	5371	\$15.00
Arthroscopic Surgical Power Unit 40, 60, 85 (Requires 2/unit)	12 Volt / 7.0 Ah	5390	\$25.00

<b>EDENTECH (NELLCOR)</b>			
2000, 2000A, 2000W Respiration Monitor	8.4 Volt / 2.4 Ah	5420	\$53.00
200A Recorder	3.5 Volt / .750 Ah	5359	\$25.00
3171 Trace Air Flow (Memory)	3.6 Volt / 1.2 Ah	5466	\$9.00

<b>ELECTROMEDICS</b>			
EEG Monitor	6 Volt / 3.0 Ah	5371	\$15.00
TCPM-2P Tourniquet	12 Volt / 0.8 Ah	5785	\$22.00

<b>ELMED INSTRUMENTS</b>			
Audio RF Meter	12 Volt / 3.2 Ah	5795	\$45.00
Neuroprobe	8 Volt / 3.5 Ah	5382	\$49.00

<b>ERGOLET</b>			
Luna Patient Lift	36 Volt / 2.3 Ah	6135	\$120.00

<b>ERGOTRON</b>			
SV21, SV22 Cart (99-166)	12 Volt / 55.0 Ah	6269	\$256.50
SV32 Cart (97-479)	12 Volt / 35.0 Ah	6258	\$125.95

<b>ESHMANN</b>			
RX501 Table	12 Volt / 26.0 Ah	5393	\$67.00

<b>EVO MEDICAL</b>			
Vacumax 605 Portable Aspirator (20098)	12 Volt / 2.0 Ah	5771	\$42.00

<b>EXECUTONE INFORMATION SYSTEMS</b>			
Futura II Nurse Call (Requires 2/unit)	12 Volt / 9.0 Ah	5796S	\$43.00
Lifesaver System (Requires 4/unit)	12 Volt / 9.0 Ah	5796S	\$43.00

<b>FERNO ILLE</b>			
125, 128, 129 Chair Lift (Requires 2/unit)	12 Volt / 18.0 Ah	5391	\$65.00
1600, 9600, 9650 Chair Lift	12 Volt / 7.0 Ah	5390	\$25.00
190, 193, 194 Chair Lift	12 Volt / 26.0 Ah	5394	\$67.00
196, 197, 300 Chair Lift	12 Volt / 26.0 Ah	5392	\$67.00
5000, 6000 Chair Lift (Requires 2/unit)	12 Volt / 7.0 Ah	5390	\$25.00
Aquasizer 300	12 Volt / 2.9 Ah	5385	\$29.00
POWERflexx (Requires 2/unit)	12 Volt / 7.2 Ah	5780	\$34.00
T.H.E. Medical Lift (Requires 4/unit)	6 Volt / 10.0 Ah	5380	\$18.00
TR3000 Shower Trolley	12 Volt / 7.0 Ah	5390	\$25.00

<b>FISHER-BERKELEY</b>			
Freezer Backup (28109601)	12 Volt / 1.3 Ah	5383	\$18.50
Nurse Call Intercom HQIB	12 Volt / 7.2 Ah	5780	\$34.00
Nurse Call Intercom HQI, HQIX	12 Volt / 5.0 Ah	5388	\$25.00

MEDICAL BATTERIES MFG/MODEL VOLTAGE/CAPACITY R&D PART LIST PRICE

**FISHER SCIENTIFIC**

212Z Isotemp Freezer	12 Volt / 7.0 Ah	5390	\$25.00
Tissue Processor 266MP (Memory)	3.6 Volt / .15 Ah	5552	\$15.00

**FLO HEALTHCARE**

Mobile Cart 1750	12 Volt / 24.0 Ah	6259	\$67.00
Mobile PC Cart (3835-0016) (Requires 4/unit)	14.4 Volt / 10.0 Ah	6061	\$420.00
Mobile PC Cart (Square Connector) (400311-09000 REV F)	14.4 Volt / 8.0 Ah	6294	\$420.00

**FLUKE (METRON)**

45-01K (822262)	8 Volt / 2.5 Ah	5059	\$33.00
700, 740, 800, 867 Series Calibrator (BP7235, DSP4300)	7.2 Volt / 3.5 Ah	6016-NiMH	\$250.00
8010A, 8012A, 8050A, 8600 Digital Multimeter	2.4 Volt / 2.4 Ah	5563	\$15.00
92, 95, 96, 97, 99, 105, 164 Multimeter	4.8 Volt / 2.4 Ah	5757	\$30.00
Data Simulator 6100	12 Volt / 2.5 Ah	5515	\$20.00
Impulse 4000, 4600 Defibrillator/Analyzer	12 Volt / 2.5 Ah	5515	\$20.00
LAN Meter 672 (663135)	10.8 Volt / 3.0 Ah	6267	\$125.00
Oxitest 2000, Oxitest 7 Plus (3310-003)	7.2 Volt / 1.4 Ah	5203	\$27.00
PM9086, KR 27/50 Scope Meter	4.8 Volt / 2.4 Ah	5757	\$30.00
Quality Analyzer 43, 43B	4.8 Volt / 1.8 Ah	6031	\$30.00
RF303 Electrosurgery Analyzer	12 Volt / 2.5 Ah	5515	\$20.00
Scope Meter BP123, 124 (BP120, PB120, PB130)	4.8 Volt / 1.8 Ah	6031	\$30.00
Scope Meter BP192, 196B, 199C (BP190)	7.2 Volt / 4.0 Ah	5173	\$48.00
Sigmapace 1000 External Pacemaker Analyzer	7.2 Volt / 2.7 Ah	6128	\$45.00

**FORMA SCIENTIFIC**

Enviroscan Monitor 8500, Refrigeration Alarm 8400, 8407, 8416, 8516	6 Volt / 8.0 Ah	5882	\$36.60
Freezer Alarm 5473	2.4 Volt / .70 Ah	6054	\$12.00
Freezer CO2 189054	6 Volt / 36 Ah	5988-F2	\$80.00
Incubator Alarm 3605 (Requires 4/unit)	1.2 Volt / .70 Ah	5397	\$2.65

**FUKUDA DENSHI (BRENTWOOD)**

10TH-2400A, DS5100	12 Volt / 4.0 Ah	5072	\$95.00
3300	7.2 Volt / .180 Ah	5399	\$9.45
Cardimax FX-3010 ECG (HHR-19AL24G1FD)	9.6 Volt / 2.1 Ah	6300	\$60.00
DS7100 Dynascope (T4UR18650F-2-4644) (OEM)	14.4 Volt / 4.3 Ah	6422	\$498.00
FC 700A Monitor Defibrillator (Requires 2/unit)	12 Volt / 1.8 Ah	5226	\$37.00
FCP-2101, FCP-2201 ECG (Memory)	3.6 Volt / 1.2 Ah	5959	\$11.00
FCP-2101, FCP-2201 Electro Cardiogram	12 Volt / 1.8 Ah	5951	\$65.00
FCP-4101 ECG (Memory)	3.6 Volt / 1.2 Ah	6301	\$11.00

**GAMBRO**

Phoenix System (6973440)	12 Volt / 7.0 Ah	5390	\$25.00
--------------------------	------------------	------	---------

**GENERAL ELECTRIC (CRITIKON, MARQUETTE)**

Aisys Carestation Anesthesia Delivery System (Requires 2/unit)	12 Volt / 12.0 Ah	5551	\$45.00
--	-------------------	------	---------

**GENERAL ELECTRIC (CRITIKON, MARQUETTE) ... continued from previous page**



AMX110, II, III, CMX (18.0Ah)  
(Requires 10/unit)

12 Volt / 18.0 Ah 5391 \$65.00



AMX110, II, III, CMX, AMX IV  
Genesis G26EP (Single Battery)  
(Requires 9/unit)

12 Volt / 26.0 Ah 5970 \$194.00

\*Complete set available with  
brackets part number 5967\*



AMX110, II, III, CMX, AMX IV  
(Panasonic 28.0 Ah) (Requires  
9/unit)

12 Volt / 28.0 Ah 5850 \$110.00

AMX-110, II, III Portable Set of (9) 12 Volt / 26Ah Batteries in three trays with constant voltage charge board, installation manual 108 Volt / 26.0 Ah 6239 \$1,575.00

AMX-110, II, III Portable Set of (9) Batteries in three trays 12 Volt / 26Ah 108 Volt / 26.0 Ah 6240 \$1,250.00

AMX-110, II, III Portable Set of (9) Batteries in three trays with constant voltage charge board, kicker panel and installation manual Direct replacement for NiCd battery systems. 12 Volt / 26Ah 108 Volt / 26.0 Ah 6238 \$1,750.00

AMX-III Portable Set of (10) 12 Volt / 22Ah Batteries in two trays 120 Volt / 22.0 Ah 6237 \$1,140.00

AMX-III Portable Set of (10) Batteries in two trays with constant voltage regulator board, 100 ohm 25 watt resistor, new E-Proms and installation manual 12 Volt / 22Ah 120 Volt / 22.0 Ah 6236 \$1,550.00

AMX IV Genesis G26EP \*9 Battery Set with Brackets\* 108 Volt / 26.0 Ah 5967 \$1,625.00

AMX IV Hawker SBS30 (Orange Battery) (Requires 9/unit) 12 Volt / 26.0 Ah SBS30 \$242.00

AMX-IV, IV Plus Portable Set of (9) Batteries G26EP Genesis batteries with brackets 12 Volt / 26Ah 108 Volt / 26.0 Ah 5967 \$1,625.00

AMX-IV, IV Plus Set of (9) Batteries Pre-Assembled in three trays 12 Volt / 30Ah 108 Volt / 30.0 Ah 6244 \$1,525.00

AMX-IV, IV Plus Set of (9) Genesis Batteries Pre-Assembled in three trays with sensor board to read individual voltages and installation manual - Recommended Replacement battery 108 Volt / 26.0 Ah 6242 \$2,500.00

AMX-IV, IV Plus Set of (9) Pre-Assembled in three trays with sensor board to read individual battery voltages and installation manual HBS 12 Volt / 30Ah Batteries 108 Volt / 30.0 Ah 6243 \$1,625.00





**HEALTHDYNE TECHNOLOGIES (NARCO, RESPIRONICS) ... continued from previous page**

900S, 930S, 950S, 970S Smart Monitor (Memory)	5.0 V / 16Kbit	6386	\$24.00
930 Pulse Oximeter	6 Volt / 2.3 Ah	5492	\$35.00
Healthdyne 2000	4 Volt / 1.0 Ah	5396	\$35.00
Pressure Support Ventilator 7700	8.4 Volt / .180 Ah	5398	\$9.45
Smart 2 Monitor	6 Volt / 2.1 Ah	5996	\$45.00

**HEARTSINE**

Adult Samaritan PAD Pak (Pad-Pak-01) (OEM)	Adult Electrode Pad & Battery - OEM	6270	\$215.00
Child Samaritan PAD Pak (Pad-Pak-02) (OEM)	Child Electrode Pad & Battery - OEM	6271	\$250.00

**HEINE**

Accubox II (X-04.99.624) (Save Original Connector)	6 Volt / 1.4 Ah	6150	\$40.00
Accubox Portable Bio Power Supply (X-04.99.623) (Retrofit)	6 Volt / 1.2 Ah	6362	\$40.00
Accubox Portable (X-04.99.623) (Insert) (Save Harness)	6 Volt / 1.2 Ah	6362-I	\$40.00
Beta R, TR, NT Handle (X-02.99.380, X-02.99.382)	3.5 Volt / 1.0 Ah	6169	\$65.00
Beta Slim, Alpha+ Compact Handle (X-02.99.106) (OEM)	3.5 Volt / .60 Ah	6170	\$80.00
M2Z, NP200 (F22-804)	2.4 Volt / .70 Ah	5621	\$15.00
M-Pack (X-04.99.675) (OEM)	7.4 Volt / 1.0 Ah	6304	\$269.00

**HELENA LABRATORIES (ARRAY MEDICAL)**

Actalyke Analyzer	7.2 Volt / 5.0 Ah	6021	\$60.00
Actalyke Mini II (5754)	10.8 Volt / 1.1 Ah	6404	\$30.00
Actalyke XL 5770 (5759)	10.8 Volt / 9.0 Ah	6252	\$245.00

**HENLEY INTERNATIONAL**

Sono Pulse 64, 434, 463, 464 Ultrasound	12 Volt / 2.5 Ah	5386	\$20.00
---	------------------	------	---------

**HESKA VETERINARY**

IV Infusion Pump	7.2 Volt / 1.1 Ah	6097	\$30.00
------------------	-------------------	------	---------

**HILLROM**

Active Care DTV System (503-A-0001-01)	7.2 Volt / 1.6 Ah	6200	\$28.50
Affinity Birthing Bed, Sport Bed	12 Volt / 7.2 Ah	5780	\$34.00
Care Assist (P1170E) (Requires 2/unit)	12 Volt / 1.2 Ah	5838	\$20.00
Century CC Critical Care Bed Scale 891, 893	6 Volt / 2.8 Ah	5370	\$15.00
Composer (Requires 2/unit)	12 Volt / 12.0 Ah	5551	\$45.00
Criticare Bed Scale	6 Volt / 3.2 Ah	5373	\$22.00
Excel Care (Requires 2/unit)	12 Volt / 7.0 Ah	5390	\$25.00
Infant Scale N15	12 Volt / 2.5 Ah	5515	\$20.00
Liftem Portable Lift (Requires 2/unit)	12 Volt / 2.9 Ah	5969	\$38.00
Light Source LT90700, P4430LB	7.2 Volt / 1.8 Ah	5810	\$35.00
Nurse Call	3.0 V Lithium	5765	\$4.25
ON3 Lateral Transfer Device	12 Volt / 12.0 Ah	5551	\$45.00
Total Care Bed (4840501)	12 Volt / 7.2 Ah	5780	\$34.00
Trans Lift P4401B (Requires 2/unit)	12 Volt / 2.9 Ah	5969	\$38.00
Versa Care Bed (Requires 2/unit)	12 Volt / 12.0 Ah	5551	\$45.00
Versa Care OR P3200E (Requires 2/unit)	12 Volt / 7.2 Ah	5780	\$34.00
Versa Care OR P3200K (Requires 2/unit)	12 Volt / 5.5 Ah	5388-F2	\$33.00



**IMPACT ... continued from previous page**

Vac Pac II, 321 Aspirator	12 Volt / 2.0 Ah	5631	\$22.00
---------------------------	------------------	------	---------

**INFRASONICS (NELLCOR, PURITAN BENNETT)**

Adult Star, Star Sync (Memory)	4.8 Volt / .11 Ah	5695	\$15.00
Adult Star Ventilator 1010, 1500, 2000	12 Volt / 7.0 Ah	5741	\$25.00
Infant Star 100 Ventilator	12 Volt / 1.3 Ah	5383	\$18.50
Infant Star 500, 950 Ventilator	10 Volt / 2.5 Ah	5342	\$53.00

**INNERSPACE**

ET4000MOT Medication Cart	12 Volt / 33.0 Ah	5395	\$85.00
---------------------------	-------------------	------	---------

**INOGEN**

One Portable Oxygen Concentrator (BA-100) (OEM)	14.8 Volt / 6.6 Ah	6281	\$325.00
---	--------------------	------	----------

**INSTRUMED**

Smart Pump	12 Volt / 2.2 Ah	5991	\$27.00
SP-1C, SP-2CX Smart Pump Tourniquet (0AXINST10, 0AXSTGX10)	12 Volt / 2.7 Ah	6185	\$95.00

**INTELLIGENT MEDICAL SYSTEMS (FIRST TEMP)**

First Temp Thermometer 2000A (Short - 3in High)	2.4 Volt / 2.3 Ah	5012	\$14.50
First Temp Thermometer 2000A (Tall - 4 3/4in High)	2.4 Volt / 4.3 Ah	5006	\$21.50

**INTELLIKEY COROPORATION**

1002255	10.8 Volt / 4.9 Ah	6222	\$75.00
---------	--------------------	------	---------

**INTERNATIONAL TECHNIDYNE (HEMOCHRON, TECHNIDYNE)**

Hemochron 400, HE 5-1	6 Volt / 1.8 Ah	5296	\$27.00
Hemochron 401, HE 5-3	7.2 Volt / 1.8 Ah	5479	\$33.00
Hemochron 8000	12 Volt / 5.0 Ah	5897	\$109.00
Hemochron 801, HE 5-4	7.2 Volt / 2.4 Ah	5470	\$45.00
Hemochron Jr. (FA5008 Rev. A)	7.2 Volt / .70 Ah	5874	\$30.00
Hemochron Response 8430 (HR1217X)	7.2 Volt / 5.0 Ah	5083	\$68.00
Hemochron Signature Jr Analyzer	8.4 Volt / .800 Ah	5974	\$49.00
Hemochron Signature Jr Analyzer (HJ6011X) (Send in for Retrofit)	8.4 Volt / 1.6 Ah	5974-NiMH	\$49.00

**INVIVO RESEARCH**

Escort M12 Anesthesia Monitor	12 Volt / 2.3 Ah	5389	\$40.00
Expression MRI Patient Monitor (989803169491)	14.8 Volt / 5.08 Ah	6369	\$695.00
HL20 Rotaflow (702755)	24 Volt / 5.5 Ah	6412	\$225.00
M8 Vital Signs Monitor	11.1 Volt / 7.2 Ah	6181	\$129.00
Magnitude Patient Monitor 3150M	12 Volt / 7.0 Ah	5390	\$25.00
MDE Prism VSM, Escort M10 (E2700-37SE7)	12 Volt / 7.0 Ah	5045	\$35.00
Millenia MVS, 3155, 3500, 3550A, HB10 (Requires 3/unit)	12 Volt / 2.3 Ah	5389	\$40.00
Millennium 3500, 3500U Multiparameter Monitor	12 Volt / 2.3 Ah	5389	\$40.00
MRI Monitor 3150, HB02 (Requires 4/unit)	12 Volt / 7.2 Ah	5780	\$34.00
MRI Monitor 4500, 4500 Plus, HB03	12 Volt / 2.5 Ah	5515	\$20.00
Omega 1400, 1445 Blood Pressure Monitor	12 Volt / 2.5 Ah	5515	\$20.00
Omega 500, 1000, 1100, 1500, 5000 BP Monitor	12 Volt / 7.0 Ah	5390	\$25.00
Precess Wireless Module (989803152881) (9065) (OEM)	3.7 Volt / 1.8 Ah	6415	\$289.00
Pulse Oximeter 4500, 4500 Plus, 5600, Plus 3, HB07	8 Volt / 2.5 Ah	5059	\$33.00

MEDICAL BATTERIES MFG/MODEL VOLTAGE/CAPACITY R&D PART LIST PRICE

**INVIVO RESEARCH ... continued from previous page**

Scout 4500 Mini O2 Monitor, HB08	4.8 Volt / 1.8 Ah	5711	\$18.00
----------------------------------	-------------------	------	---------

**INVOS**

4100	8 Volt / 3.5 Ah	5382	\$49.00
------	-----------------	------	---------

**ITC**

Protime Microcoagulation System (IR5206X REV. E) (Retrofit)	7.2 Volt / 1.6 Ah	6204	\$68.00
---	-------------------	------	---------

**IVY BIOMEDICAL SYSTEMS**

ECG Monitor 700, 701, 702, 704 (2 Battery Set)	12 Volt / 7.0 Ah	5542	\$32.00
Monitor 201, 202, 303, 401, 402, 403, 2310	12 Volt / 2.8 Ah	5119	\$30.00
Monitor 2310, Recorder 501	12 Volt / 2.8 Ah	5119	\$30.00
Monitor 303A, 404 (Requires 2/unit)	12 Volt / 2.8 Ah	5119	\$30.00
Monitor 405C, 405 Plus (Requires 2/unit)	12 Volt / 2.3 Ah	5389	\$40.00

**JACO**

Ultra SLeRx CPU (EVH12150F2)	12 Volt / 14.0 Ah	6225	\$68.00
------------------------------	-------------------	------	---------

**JEWETT REFRIGERATOR**

Freezer Alarm (LTU17A14) (28109601)	12 Volt / 1.3 Ah	5383	\$18.50
Temperature Monitor TMS-RB,TPM1 (Alarm)	4.8 Volt / .70 Ah	5802	\$12.00

**JONES MEDICAL INSTRUMENTS**

Satellite Spirometer	7.2 Volt / .70 Ah	5332	\$30.00
----------------------	-------------------	------	---------

**KEELER**

Ophthalmoscope Pre-Vista (CJB-191) (77mm)	3.6 Volt / .75 Ah	6221	\$25.00
Ophthalmoscope Vista (1919-P-7069) (81mm)	3.6 Volt / .75 Ah	6220	\$25.00

**KELLER MEDICAL**

KMS 850, 870, 890, 950	12 Volt / 2.0 Ah	5771	\$42.00
Life Signs 880 Monitor Defibrillator	12 Volt / 2.3 Ah	5387	\$45.00

**KINETIC CONCEPTS**

315B Vacuum Assisted Closure	12 Volt / 2.5 Ah	5515	\$20.00
Kin Airbed Temp Transport	12 Volt / 33.0 Ah	5395	\$85.00
VAC ATS Therapy System (M3252795A)	12 Volt / 3.7 Ah	6442	\$160.00

**KONTRON (ROCHE, ARROW INTERNATIONAL)**

105, 205, 7141, 7142, 7640 Monitor	12 Volt / 7.0 Ah	5390	\$25.00
7501 Defibrillator	12 Volt / 2.5 Ah	5515	\$20.00
7840200, 7845000 Oximeter	6 Volt / 1.0 Ah	5368	\$9.00
Autocart Wave (Sonnenschein) (4 Battery Set)	48 Volt / 10.0 Ah	6020	\$352.00
Autocat 2 Wave	12 Volt / 20.0 Ah	6040	\$88.00
Balloon Pump 10, 3010-G	6 Volt / 20.0 Ah	5378	\$50.00
Balloon Pump 27	6 Volt / 3.2 Ah	5373	\$22.00
Balloon Pump 7	6 Volt / 10.0 Ah	5380	\$18.00
Balloon Pump K2000	12 Volt / 26.0 Ah	5393	\$67.00
Balloon Pump KAAT 7000, M700 (Requires 2/unit)	12 Volt / 18.0 Ah	5391-F2	\$65.00
Cardiac Output 7300, 7350, KAAT II	12 Volt / 7.0 Ah	5390	\$25.00

**KONTRON (ROCHE, ARROW INTERNATIONAL) ... continued from previous page**

Combo Sensor	12 Volt / 7.0 Ah	5390	\$25.00
Inter. ECG Simulator	6 Volt / 3.0 Ah	5371	\$15.00
KAAT II Plus	12 Volt / 18.0 Ah	5391	\$65.00
KAAT II Plus	12 Volt / 26.0 Ah	5393	\$67.00
KAAT I Plus	12 Volt / 18.0 Ah	5391	\$65.00
KAAT (Memory)	1.2 Volt / .180 Ah	5620	\$3.00

**KOWA**

SL-14 Handheld Slit Lamp (ASL-PP14) (Insert)	7.2 Volt / 2.1 Ah	6226-I	\$40.00
SL-14 Handheld Slit Lamp (ASL-PP14) (Send in for Retrofit)	7.2 Volt / 2.1 Ah	6226	\$45.00

**LAERDAL (CARDIAC RESUSCITATOR)**

7050 Series Suction Pump AE7000 (79-12-05)	12 Volt / 1.8 Ah	5025	\$40.00
7800 2001 Suction Unit (780800) (OEM)	12 Volt / 2.0 Ah	6435	\$129.00
AED Trainer (930090, 901100)	12 Volt / 2.3 Ah	5387	\$45.00
Cardiac Resuscitator Heart Aid 95	12 Volt / 7.0 Ah	5390	\$25.00
Cardiac Resuscitator Heart Aid Defibrillator 80, 88	12 Volt / 2.5 Ah	5170	\$52.50
Compact Suction Pump 880001, 881201, 880005	12 Volt / 1.3 Ah	5383	\$18.50
Heartstart 1000, 3000 (Training)	12 Volt / 7.0 Ah	5390	\$25.00
Heartstart 1000, Heart Aid 285, 005, Heart Aid 53 (Retrofit)	12 Volt / 1.2 Ah	5276	\$55.00
Heartstart 3000 (Memory)	3 Volt / .56 Ah	5851	\$4.50
Heartstart 4000 (780400)	12 Volt / 2.3 Ah	5389	\$40.00
Heartstart 911, 2000, 3000, 3000QR Defibrillator (901100)	12 Volt / 2.3 Ah	5387	\$45.00
LCSU3 Suction Unit 88005001, 8800601 (102963 Rev C, 88007005, OEM)	12 Volt / 1.65 Ah	6316	\$145.00
 LCSU Compact Suction Unit (880020, 884301)	12 Volt / 2.5 Ah	5975	\$54.00
LSU Suction Unit	12 Volt / 2.3 Ah	5389	\$40.00
Premier Suction Unit	6 Volt / 3.4 Ah	5675	\$29.00

**LARSEN & TOUBRO**

Star 50 Patient Monitor	12 Volt / 2.3 Ah	5389	\$40.00
-------------------------	------------------	------	---------

**LIFE LINE SYSTEMS**

4000, 4300, 4500, 5000, 5200, 5500	6 Volt / 1.0 Ah	5593	\$10.50
Care Giver 6200, 6500, 6600, 8500, 9000	6 Volt / .50 Ah	5772	\$15.00
CPAP, BIPAP Alarm (Memory)	3.6 Volt / .11 Ah	5449	\$11.25
ERC 400 Base Unit (Requires 4/unit)	6 Volt / 7.0 Ah	5375	\$18.00
L6700T	3.6 Volt / .70 Ah	6142	\$18.50
RC Switchboard	6 Volt / 7.0 Ah	5375	\$18.00
Switchboard	6 Volt / 10.0 Ah	5380	\$18.00
Voice Unit LC202E	6 Volt / 1.0 Ah	5368	\$9.00

**LIFELOC TECHNOLOGIES**

BP10140101Q Printer (69100442)	4.8 Volt / .70 Ah	6145	\$15.00
--------------------------------	-------------------	------	---------

**LIFELOC TECHNOLOGIES ... continued from previous page**

Phoenix Breathelizer	9.6 Volt / 1.1 Ah	6136	\$45.00
----------------------	-------------------	------	---------

**LIFE SYSTEMS**

Rosie II Blood Glucose Monitoring System	6 Volt / 5.0 Ah	6014 B	\$48.00
--	-----------------	--------	---------

**LIFETECH, INC.**

MiniStim Nerve Stimulator MS-1	7.5 Volt / .11 Ah	5803	\$9.85
--------------------------------	-------------------	------	--------

**LIKO**

3000, Viking Series Patient Lift (Requires 2/unit)	12 Volt / 2.9 Ah	5969	\$38.00
Golvo 7000, 7007ES (Requires 2/unit)	12 Volt / 2.9 Ah	5969	\$38.00
Likorall R2R, 243, 250ES Patient Lift (Requires 2/unit)	12 Volt / 2.6 Ah	5082	\$34.00
MultiRall 200 (Requires 2/unit)	12 Volt / 2.5 Ah	5515	\$20.00
Sabina, Sabina II Patient Lift (Requires 2/unit)	12 Volt / 2.9 Ah	5969	\$38.00

**LIONVILLE SYSTEMS**

800 Cart UPS (Requires 2/unit)	12 Volt / 16.0 Ah	G16EP	\$140.00
Classic 600	12 Volt / 5.0 Ah	5388	\$25.00
iPoint Mobile Cart (Requires 2/unit)	12 Volt / 26.0 Ah	5970	\$194.00
Medication Cart (34015)	12 Volt / 7.2 Ah	6004	\$49.00
Medication Cart (34082) (Alkaline)	6 Volt / 20.5 Ah	6047	\$12.00
Medication Cart 400, 600, 800 (34016-2) (Requires 2/unit)	6 Volt / 7.0 Ah	5375	\$18.00
Medication Cart 624-D, 818-D (9824)	12 Volt / 5.0 Ah	5388	\$25.00
MMP Medcart MC21	12 Volt / 7.2 Ah	5780	\$34.00

**MAQUET-STIERLEN**

Accumulator	12 Volt / 2.5 Ah	5515	\$20.00
Alphamaquet Bariatric Table 1150	12 Volt / 8.0 Ah	6397	\$165.00
Alphamaxx OR Table 1132.1, 1133.12 (Requires 2/unit)	12 Volt / 18.0 Ah	5391	\$65.00
Alpha Star 1130, 1132.03 (8512C-15GS) (Requires 2/unit)	12 Volt / 18.0 Ah	5391	\$65.00
Alpha Table (Set of 2)	12 Volt / 8.0 Ah	6224	\$145.00
HL20	12 Volt / 30 Ah	6286	\$345.00
OR Table 1000 (Requires 2/unit)	12 Volt / 12.0 Ah	5551	\$45.00



OR Table 1130.01, 1130.02, 1420.01B (Requires 4/unit)

12 Volt / 12.0 Ah	5551	\$45.00
-------------------	------	---------



OR Table 1131.02, 1533.01BO (Sonnenschein) (Requires 4/unit)

12 Volt / 10.0 Ah	6018	\$88.00
-------------------	------	---------

Servo-I, Servo-S, Adult, Infant, Universal (06194687) (Memory)	3.6 Volt / 2.5 Ah	5952	\$11.00
Servo-i, Servo-S Adult, Infant, Universal Battery Module (6487180)	12 Volt / 4.0 Ah	5058-A	\$265.00

**MAQUET-STIERLEN ... continued from previous page**

	Servo-I, Servo-S Adult, Infant, Universal Battery Module (64-87-180) (OEM)	12 Volt / 4.0 Ah	5058	\$445.00
	Telemaquet Remote Controller D-7550	10.8 Volt / .25 Ah	5805	\$32.00

**MARCAL (GRASEBY)**

	Infusion Pump 3000, 5001	12 Volt / 1.2 Ah	5838	\$20.00
	Infusion Pump 3100, 3400, 3500 (Requires 3/unit)	2 Volt / 2.5 Ah	5217	\$7.25

**MARCO**

	KM500 Handheld Keratometer (Insert)	6 Volt / 1.1 Ah	6288	\$48.00
--	-------------------------------------	-----------------	------	---------

**MARQUETTE ELECTRONICS (GE)**

	1000, 1100 Responder Defibrillator (Insert)	18 Volt / .70 Ah	6189-I	\$60.00
	1000, 1100 Responder Defibrillator (Send in for Retrofit)	18 Volt / .70 Ah	6189	\$65.00
	1200, 1500 Responder Defibrillator (Send in for Retrofit/Exchange)	24 Volt / 1.8 Ah	5278	\$100.00
	2230, 2250, 2310, 2330 ECG Monitor	12 Volt / 2.8 Ah	5119	\$30.00
	280, 280A, 300, 360 Series, Mini Monitor 6 (Send in for Retrofit)	24 Volt / .52 Ah	5189	\$77.00
	7200 TRAM (Memory)	3.6 Volt / 1.2 Ah	5466	\$9.00
	900 Monitor Defibrillator Recorder, Light Guard 9	24 Volt / 1.8 Ah	5278	\$100.00
	901 Monitor, 7010, 7200 TRAM Portable Monitor	12 Volt / 2.3 Ah	5387	\$45.00
	Cardioserv 360 (92916531) (Send in for Retrofit)	18 Volt / .70 Ah	6311	\$65.00
	Cardioserv SCP910/913/915/922 (303-440-30) (OEM)	12 Volt / 1.3 Ah	6324	\$119.00
	Case 15, 16 Central Console	3.6 Volt / .60 Ah	5653	\$18.00
	CD Telemetry (Memory)	3.6 Volt / .60 Ah	5653	\$18.00
	Dash 1000 (303-444-09) (2 Pin)	12 Volt / 2.0 Ah	5954 A	\$145.00

	Dash 2000 (929-167-81 REV. B) (4 Pin)	12 Volt / 2.0 Ah	5954	\$145.00
---	--	------------------	------	----------

	Dash 2500 (2023852-029)	8.4 Volt / 7.0 Ah	6345	\$289.00
	Dash 3000/4000/5000 Pro Transport (2017857-002) (OEM) (2/unit)	11.1 Volt / 4.2 Ah	5071 B	\$325.00

	Dash 3000/4000/5000 (SM201-6) Pro Transport (Requires 2/unit)	11.1 Volt / 4.2 Ah	5071	\$195.00
---	--	--------------------	------	----------

	Dash 4000 (Memory)	3 Volt / .56 Ah	5851	\$4.50
	Dash Responder (2001850-001, 2009219-001) (OEM)	12 Volt / 2.0 Ah	6360	\$595.00
	Dash Responder 3000 (2009218-001, 2009218-001) (OEM)	12 Volt / 2.0 Ah	6361	\$555.25

**MARQUETTE ELECTRONICS (GE) ... continued from previous page**

	Eagle 4000 Series Monitor (406679-003)	12 Volt / 2.4 Ah	5623	\$80.00
	Eagle Series, Tram 200SL, 850A (Memory)	3 Volt / 1.0 Ah	5878	\$4.95
	EMS-BP711 Blood Pressure Monitor	6 Volt / 1.2 Ah	5369	\$10.00
	Mac 1000, 1100, 1200 Cardio Smart EKG (303-442-70)	18 Volt / 1.8 Ah	5877	\$95.00
	Mac 1000, 1200 (Clock Battery)	3 Volt / .95 Ah	5976	\$9.00
	Mac 1000, 1200, EK6 (Memory)	3 Volt / .255 Ah	6033	\$6.00
	Mac 12, 15 Recorder Clock (401086-002) (Micro Processor)	3.6 Volt / .60 Ah	5653	\$18.00
	Mac 1600 (2035701-001) (OEM)	14.8 Volt / 2.3 Ah	6433	\$535.00
	Mac 2, 12, 15 ECG Recorder, 7010, 7700 Clock (Requires 2/unit)	3.6 Volt / .15 Ah	5552	\$15.00
	Mac 500	12 Volt / 1.3 Ah	5383	\$18.50
	Mac 5000, 5500, 5500 HD, Mac Pac, Mac Stress (900770-001)	18 Volt / 3.5 Ah	5962	\$189.00
	Mac 8, Mac Personal, Mac Stress (410313-002, 410313-010)	19.2 Volt / 4.5 Ah	5694	\$198.00
	Mac Lab IT (Requires 2/unit)	12 Volt / 7.2 Ah	5780	\$34.00
	Mac PC, Mac 6 (3807-001)	19.2 Volt / 1.5 Ah	5125	\$75.00
	Mac Vu-Cart (Requires 2/unit)	12 Volt / 13.0 Ah	5722	\$135.00
	Mini Dash (2016989-002, 2031069-003), (OEM). Protransport, Solar 8000i PDM Module.	11.1 Volt / 1.8 Ah	6291	\$369.00
	Procure 400 NIBP	6 Volt / 3.0 Ah	5371	\$15.00
	Solar 9500 Monitor (413079-005) (006)	13.2 Volt / 1.4 Ah	5109	\$79.00

**MASIMO**

	Rad 8 (13454)	6 Volt / 1.3 Ah	5469	\$14.00
	Rad-87	6 Volt / 1.2 Ah	5369	\$10.00
	Rad 9	12 Volt / 2.5 Ah	5515	\$20.00



**MASIMO ... continued from previous page**



Radical 7 Rainbow (48282) (2386)  
(Insert)

4.8 Volt / 1.6 Ah

6202-I

\$35.00

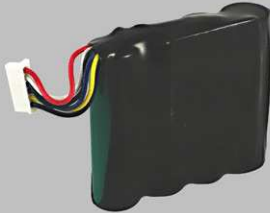

Radical 7 Rainbow (48282) (2386)  
(Send in for Retrofit)

4.8 Volt / 1.6 Ah

6202

\$35.00

Radical 7 Rainbow Set Pulse Ox (14282) (2386) (OEM)

4.8 Volt / 1.6 Ah

6202-B

\$136.00



Radical, Radical 7 Pulse Oximeter  
(1315)(Exchange)

4.8 Volt / 1.6 Ah

6028

\$65.00

Radical, Radical 7 Pulse Oximeter (1315) (OEM)

4.8 Volt / 1.6 Ah

6028-B

\$158.00

**MATRX MEDICAL INC.**

Emergency Suction Unit

12 Volt / 1.8 Ah

5027

\$48.00

First Response Suction Unit

12 Volt / 1.8 Ah

5481

\$47.00

Imaging Camera 1010

3.6 Volt / .11 Ah

5482

\$12.00

Life Defense Plus (Send in for Retrofit)

12 Volt / 2.3 Ah

5701

\$95.00

**MEDCARE PRODUCTS**



400001, 400003, 400013, 400019  
Lift Medicare, CareBare, Stand N'  
Weigh

24 Volt / 5.0 Ah

5050 A

\$66.00

Bariatric Portable Ceiling Lift (Requires 2/unit)

12 Volt / 7.0 Ah

5390

\$25.00

Cart (Requires 2/unit)

12 Volt / 12.0 Ah

5551

\$45.00

**MEDELA USA**

Clairo Vacuum Pump (600.0806)

12 Volt / 2.1 Ah

6384

\$60.00

Vario 8, 18 Pump (919.0012)

12 Volt / 2.1 Ah

6250

\$85.00





MEDICAL BATTERIES MFG/MODEL VOLTAGE/CAPACITY R&D PART LIST PRICE

**MICRO MEDICAL ... continued from previous page**

MK6 Spirometer (BAT5014) (MIM-050-14)	7.2 Volt / 1.1 Ah	6144-NiMH	\$32.00
MLA200 Spirometer	7.2 Volt / .60 Ah	5085	\$21.00
Transpacer	12 Volt / 2.5 Ah	5515	\$20.00

**MICROPACE**

EPS220 Cardiac Stimulator (Main)	12 Volt / 2.5 Ah	5515	\$20.00
EPS220 Cardiac Stimulator (Memory)	9 Volt / 1.2 Ah	5868	\$5.95

**MICROVAS TECHNOLOGIES**

Microvas II Muscle Stimulator Treatment System	24 Volt / 4.0 Ah	6197	\$185.00
--	------------------	------	----------

**MIDMARK INC. (SCHEARER)**

7100, 7300 General Surgery Table (4 Battery Set)	48 Volt / 10.0 Ah	6020	\$352.00
CTS Remote, Operating Table SE2001	12 Volt / 1.8 Ah	5807	\$60.00

**MINDRAY (DATASCOPE)**



Accutor Plus, Trio, Passport 2  
(0146-00-0069, 0146-00-0099,  
115-018015-00) (OEM)

	11.1 Volt / 4.4 Ah	6132	\$246.00
M5 Portable Ultrasound (2108-3066176, 801-2108-00062-00) (OEM)	11.1 Volt / 4.5 Ah	6340	\$1,218.50
MEC1200 Multi Parameter Monitor	12 Volt / 2.3 Ah	5389	\$40.00
VS800, PM-8000 Express, PM-9000 (M05-010001-06) (OEM)	11.1 Volt / 4.4 Ah	6277	\$246.00

**MINOLTA (KONICA MINOLTA, MARQUEST)**

101 Jaundice Meter	4.8 Volt / .35 Ah	5137	\$12.00
JM103 Jaundice Meter	2.4 Volt / .70 Ah	6030	\$12.50

**MINRAD**

Laryngoscope (310017) (Requires 2/unit)	3.9 Volt / 7.0 Ah	5580	\$98.00
---	-------------------	------	---------

**MIRA**

TR2000, TR3000, TR4000 Ophthalmic Diathermy Unit	24 Volt / 1.8 Ah	5615	\$150.00
--	------------------	------	----------

**MLA SYSTEMS**

Pippettor	3.6 Volt / .30 Ah	6114	\$12.00
-----------	-------------------	------	---------

**MOLIFT**

Nomad 1200003-04 (1220115) - Retrofit	26.4 Volt / 1.9 Ah	6457	\$90.00
Power Pac Lift (Insert)	14.4 Volt / 1.8 Ah	5067-I	\$50.00
Power Pac Lift (Send in for Retrofit)	14.4 Volt / 1.8 Ah	5067	\$60.00

**MORTARA INSTRUMENTS**

ELI 100, 200 ECG Recorder, Life Net-STM (Requires 3/unit)	6 Volt / 1.0 Ah	5368	\$9.00
ELI-10 ECG (4800-011 Rev A)	3.7 Volt / 3.4 Ah	6426	\$98.00
ELI 250	12 Volt / 2.5 Ah	5515	\$20.00
ELI 350	12 Volt / 9.0 Ah	1986	\$34.00

**MORTARA INSTRUMENTS ... continued from previous page**

ELI 350	12 Volt / 9.0 Ah	1986-F1	\$34.00
ELI 50 EKG	12 Volt / 1.2 Ah	5838	\$20.00
Portrait EKG (2 Battery Set)	18 Volt / 1.3 Ah	5888	\$85.00

**NARCO AIR SHIELDS (DRAEGER, HEALTHDYNE, VICKERS)**

AS70 Volume Infusion Pump	12 Volt / 2.5 Ah	5515	\$20.00
C100, 300 (Alarm)	7.2 Volt / .180 Ah	5399	\$9.45
C400, C450, C450QT Incubator	8.4 Volt / .32 Ah	5836	\$27.00
C550 Powerfail (Alarm)	4.8 Volt / .11 Ah	5590	\$11.25
C86H, C86 Incubator Isolette (Alarm)	2.4 Volt / 1.8 Ah	5124	\$13.00
Cardiotac Monitor	8 Volt / 3.5 Ah	5382	\$49.00
Infant Ventilator 77, 90	12 Volt / .70 Ah	5171	\$36.00
Infant Warmer 7865, 7880, PM78-1	7.2 Volt / .180 Ah	5399	\$9.45
JM103 Jaundice Meter	2.4 Volt / .70 Ah	6030	\$12.50
Oxycare Oxygen Monitor OC68-1 (Requires 2/unit)	6 Volt / 1.2 Ah	5369	\$10.00
Oxygen Monitor 12000, Cardio_Tac Monitor 4000	4 Volt / 1.0 Ah	5396	\$35.00
Portafib I, II, III (Memory)	3 Volt / .280 Ah	6182	\$4.50
Portafib I, II, III Scientific, 5001 Monitor Defibrillator	24 Volt / 1.8 Ah	5312	\$130.00
System 5, 6 HRRM 71-1, HRRM 71-2, HR 6-1 (Requires 2/unit)	6 Volt / 3.0 Ah	5371	\$15.00
Temperature Monitor 2000 (Requires 2/unit)	4 Volt / 1.0 Ah	5396	\$35.00
TI 1001	12 Volt / 26.0 Ah	5970	\$194.00
TI-13 Energy Pack	6 Volt / 10.0 Ah	5380	\$18.00
TI Double Transport 67/100/101/167/C200/C300	12 Volt / 26.0 Ah	5648	\$67.00
TI Globetrotter 500, CI Transport 500, TI 1500	12 Volt / 26.0 Ah	5393	\$67.00
TI Infant Transport 1303	6 Volt / 10.0 Ah	5380	\$18.00
TI Infant Transport 58	12 Volt / 26.0 Ah	5648	\$67.00
Transilluminator LT90700	7.2 Volt / 1.8 Ah	5810	\$35.00
Ventilator 200	12 Volt / 1.3 Ah	5383	\$18.50
Warm Weigh Infant Scale N-10, N-15	12 Volt / 2.5 Ah	5515	\$20.00

**NATUS MEDICAL**

ALGO-1 Infant Hearing Screener (Complete Set)	12 Volt / .70 Ah	5347	\$94.00
ALGO Portable Hearing Screener	12 Volt / 3.8 Ah	5989	\$130.00

**NELLCOR (AEQUITRON, INFRASONICS, PURITAN BENNETT)**

5500 Monitor (Save Original Connector)	14.4 Volt / 4.0 Ah	6151	\$125.00
Achieva Ventilator (CG2230) (External)	24 Volt / 12.0 Ah	6206	\$90.00
Achieva Ventilator (Internal)	24 Volt / 2.2 Ah	5936	\$49.00
AMI Apnea Monitor (Send in for Retrofit/Exchange)	4.8 Volt / 1.8 Ah	5930	\$45.00
Assurance 2000 Apnea Monitor	8.4 Volt / 2.4 Ah	5420	\$53.00



Atlas Monitor (6200-41)

6 Volt / 7.2 Ah

5053

\$30.00

N-1000 Pulse Oximeter (2 Battery Set) 6 Volt / 2.8Ah, 6 Volt / 4.5Ah	6 Volt / 2.8 Ah	5338	\$40.00
N-100 Pulse Oximeter	12 Volt / 2.5 Ah	5184	\$60.00
N-10 Recorder	3 Volt / 1.5 Ah	5517	\$5.25
N-180, 185 Pulse Oximeter	12 Volt / 2.3 Ah	5389	\$40.00

**NELLCOR (AEQUITRON, INFRASONICS, PURITAN BENNETT) ... continued from previous page**

N-200 Pulse Oximeter (Hawker)	6 Volt / 2.5 Ah	5303	\$34.00
N-3000, 3100, 3200 Symphony Pulse Oximeter	12 Volt / 2.0 Ah	5778	\$22.00
	N-50E Pulse Oximeter		
	N-200 Pulse Oximeter (640105) (Powersonic)	6 Volt / 2.8 Ah	5370 \$15.00
N-550 Pulse Oximeter (068916)	12 Volt / 1.3 Ah	5383	\$18.50
N-560 Oximax Pulse Oximeter (M6008-0) (069308)	9.6 Volt / 3.8 Ah	6093	\$80.00
N-6000 CO/SAO2 (Panasonic Only)	12 Volt / 3.4 Ah	5667	\$41.00
N-600 Oximax	6 Volt / 4.5 Ah	5374	\$12.00
NPB 190, 195, 290, 295, 390, 395, 595, 600 (640119)	6 Volt / 4.5 Ah	5374	\$12.00
NPB 3900, 3910, 3930, 3940, Quick Sign	6 Volt / 4.5 Ah	5374	\$12.00
NPB 4000 Monitor	6 Volt / 8.0 Ah	5882	\$36.60
NPB 70, NPB 75 Capnograph, Oximax N-85 (047173) (Insert)	7.2 Volt / 2.7 Ah	5914-I	\$50.00
NPB 70, NPB 75 Capnograph, Oximax N-85 (047173) (Retrofit)	7.2 Volt / 2.7 Ah	5914	\$60.00
P-200 Printer	4.8 Volt / .70 Ah	5250	\$18.00

**NEWPORT MEDICAL INSTRUMENTS, INC.**

E100, E100I Ventilator (Requires 3/unit)	6 Volt / 1.2 Ah	5369	\$10.00
E150 Ventilator	12 Volt / 3.4 Ah	5667	\$41.00
HT50 Ventilator (Auxiliary)	24 Volt / 2.5 Ah	6153	\$120.00
HT50 Ventilator (External)	12 Volt / 33.0 Ah	5395	\$85.00
HT50 Ventilator (Internal, Complete) (Retrofit) 12 Volt / 2.1Ah, 12 Volt / 5.5Ah	12 V Complete - Retrofit	6342-A	\$101.00
HT50 Ventilator (Internal) (SLA)	12 Volt / 5.5 Ah	5388-F2	\$33.00
HT50 Ventilator (V09-13130-60) (Internal) (NiMH) (Retrofit)	12 Volt / 2.1 Ah	6342	\$68.00
HT50 Ventilator (V09-13130-60)(OEM Complete Unit)	12 V Complete - OEM	6342-B	\$465.00

**NIHON KOHDEN**

6120A, 6210A Cardiac Output	12 Volt / 2.3 Ah	5387	\$45.00
9020, 9130K EKG, Cardiofax Q	12 Volt / 2.3 Ah	5389	\$40.00
	BSM, 2300, 2301A, 2304A, 2351A, 2354A, Lifescope I (10HR-4/3FAUC-NK) (608237)	12 Volt / 4.5 Ah	6011 \$145.00
	Cardiofax 8110A, 8340	12 Volt / 2.3 Ah	5387
Cardiofax 8830A	12 Volt / 2.3 Ah	5389	\$40.00
Cardiofax ECG 5101, 5105, 5151	12 Volt / 2.5 Ah	5386	\$20.00
Cardiofax EKG (Requires 10/unit)	1.2 Volt / .70 Ah	5397	\$2.65
Cardiofax V	12 Volt / 2.9 Ah	6326	\$38.00



<b>NIHON KOHDEN ... continued from previous page</b>			
Cardiograph 5 (Memory)	3 Volt / 1.4 Ah	5811	\$11.25
Cardio Life 7500, TEC 7521K, 9328	12 Volt / 2.9 Ah	5969	\$38.00
Cardio Life TEC 6100, 7100A, 7200A, 7300A	12 Volt / 2.3 Ah	5387	\$45.00
 Cardio Life Tec 7621K, 7631K, 7721K, 7731K, ECG-1350 (NKB-301V)	12 Volt / 3.0 Ah	6262	\$145.00
Central Station	3 Volt / 1.8 Ah	5776	\$11.25
ECG 8330A, 8340A, 8350 (Clock)	3 Volt / 1.5 Ah	5754	\$12.00
Lifescope 6, 6102A, 6105A, 6543A, 6543L, 6551A	12 Volt / 2.3 Ah	5387	\$45.00
Lifescope L, TEC-8250, 8251, 8251A, Defibrillator (NKB101), BSM 1102, 2101A, 4100, 4102, 4114A, 5105, 5153 (5650751) (OEM)	12 Volt / 1.8 Ah	5652 B	\$209.00
Lifescope L, TEC-8250, 8251, 8251A, Defibrillator (NKB101)BSM 1102, 2101A, 4100, 4102, 4114A, 5106A (5650751) (Retrofit)	12 Volt / 1.8 Ah	5652	\$60.00
Lifescope N OPV 1500, 1500K Monitor	9.6 Volt / 2.1 Ah	6042	\$60.00
Lifescope TR, BSM-6001, BSM-6301, BSM-6501, BSM-6701,(SB-671P) (OEM)	9.6 Volt / .36 Ah	6336	\$395.00
Powercart KD-802E, 8340A (Requires 2/unit)	6 Volt / 10.0 Ah	5380	\$18.00
TEC 7500, ECG 9320, 9522A	12 Volt / 2.9 Ah	6057	\$38.00
Telemetry OEC6201A	12 Volt / 2.3 Ah	5387	\$45.00

<b>NOVAMETRIX MEDICAL</b>			
1200, 1260, 7000 CO2 Monitor	12 Volt / 5.0 Ah	5388	\$25.00
500, 500A, 505, 515, 515A, 520A, 800, 840, 2001 Pulse Ox	12 Volt / 2.5 Ah	5515	\$20.00
500, 500A, 505, 515, 515A, 800, 840, 2001 Pulse Ox (Memory)	3 Volt / .240 Ah	5343	\$4.50
7100, 8100, 78100 CO2 Monitor	12 Volt / 2.5 Ah	5515	\$20.00
7300 CO2 Monitor	12 Volt / 2.3 Ah	5389	\$40.00
807, 811 CO2 Monitor	6 Volt / 1.2 Ah	5369	\$10.00
809, 809A Transcutaneous Monitor	12 Volt / 5.0 Ah	5388	\$25.00
810, 810A, 903 Transcutaneous O2CO2 Monitor	12 Volt / 5.0 Ah	5388	\$25.00
840 LCD Transcutaneous Monitor	6 Volt / 3.0 Ah	5371	\$15.00
840 VFD Transcutaneous Monitor	12 Volt / 2.5 Ah	5515	\$20.00
Capnogard 1265 Monitor	12 Volt / 2.5 Ah	5515	\$20.00
Cosmos ETCO2, TCO2, 860 Monitor	12 Volt / 2.5 Ah	5515	\$20.00
Nova 500	6 Volt / 3.0 Ah	5371	\$15.00
Tidalwave 610, 615, 710, 715, 1040 ETCO2 (400043)	7.2 Volt / 3.5 Ah	5964	\$119.00

<b>NxStage</b>			
System One Portable Hemodialysis (Nx1000-Z)	8.4 Volt / 4.0 Ah	6363	\$90.00

<b>OEC</b>			
6800, 9600, 9800 C-Arm (Memory)	3 Volt / .255 Ah	6033	\$6.00
85 Power Unit (Requires 2/unit)	12 Volt / 7.0 Ah	5390	\$25.00
8800, 9600, 9800, 9800+, 9900 C-Arm (Block SLA Cells) (2 Battery Set)	192 Volt / 2.9 Ah	5102-B	\$915.00
8800, 9600, 9800, 9900 C-Arm (EnerSys Cyclon Cells)(5327368) (2 Battery Set) (00-900589-1)	192 Volt / 2.5 Ah	5102	\$865.00
9000, 9400 C-Arm (5.0Ah Block SLA Cells) (3 Battery Set)	180 Volt / 5.0 Ah	5101-B	\$915.00
9000, 9400 C-Arm (EnerSys Cyclon Cells) (00-871327-01) (3 Battery Set)	180 Volt / 5.0 Ah	5101	\$915.00
9000 9400 C-Arm (Memory)	4.5 V Clock Battery	840/844	\$18.00





<b>OHMEDA (DATEX) ... continued from previous page</b>			
Pulse Oximeter 3740, 3760, 3760P	12 Volt / 2.5 Ah	5515	\$20.00
Pulse Oximeter 3800, 3900, 3901 (6050-0003-715)	8 Volt / 3.2 Ah	5921	\$35.00
Pulse Oximeter 504US	6 Volt / 4.5 Ah	5374	\$12.00
Thermometer 5800	4.8 Volt / 1.8 Ah	5100	\$17.50
Transport Isolette (217-3813-910)	12 Volt / 26.0 Ah	5394	\$67.00
Transport Isolette (Requires 2/unit)	6 Volt / 36 Ah	5988-F2	\$80.00
TruStat Pulse Oximeter (6050-0006-578 REV. J)	4.8 Volt / 3.2 Ah	6125	\$85.00

<b>OLYMPIC MEDICAL</b>			
Bili Dosimeter	8.4 Volt / .180 Ah	5398	\$9.45
Bili Timer, Light Meter (Requires 4/unit)	1.2 Volt / .70 Ah	5397	\$2.65
Smart Scale 20, 30 (400679-01)	10.8 Volt / 1.8 Ah	5892	\$55.00
Smart Scale 23, 25, 56320, 56350, 57330 (400850-01) (60/65)	7.2 Volt / 1.8 Ah	5830	\$40.00
Smart Scale 50 (401391-01)	7.2 Volt / 1.8 Ah	5830-A	\$40.00
Smart Scale (Individual Cells, KR2000C) (Requires 6/unit)	1.2 Volt / 2.3 Ah	5403	\$6.85
Trans-Lite 57122, 57124, 57127, 57193, 57194 (Insert)	6 Volt / 1.8 Ah	5296	\$27.00

<b>OLYMPUS MEDICAL</b>			
BR401 (Requires 4 per unit)	1.2 Volt / 2.1 Ah	5397-NiMh	\$3.00
CV100, CLE-10, CVL-10, CVI Light Source (DP034200)	3.0 Volt / 1.8 Ah	5779	\$11.25
 CV100, CLV-U20, CLV-U40 (GU142400)	3.6 Volt / 1.2 Ah	5084 B	\$9.00
CV200 Light Source (GU124400)	3.6 Volt / 1.2 Ah	5084 A	\$9.00
Evis CV-160 Processor	2.8 V Timekeeper	6315	\$15.00
Fiber Optic Scope	3 Volt / 1.5 Ah	5517	\$5.25

<b>OMEGA</b>			
110 Portable Oscilloscope	9.6 Volt / 1.5 Ah	6121	\$36.00

<b>OMNICELL</b>			
Med Dispenser	18 Volt / 2.8 Ah	6276	\$52.00

<b>OMRON HEALTHCARE</b>			
BP-S510 Patient Monitor	12 Volt / 3.8 Ah	5963	\$199.00
HEM-907 Blood Pressure Unit (48H907N)	4.8 Volt / 1.6 Ah	6209	\$15.00

<b>ORDION</b>			
Microcap/Vitalcap (Insert Only)	7.2 Volt / 2.7 Ah	5914-I	\$50.00

<b>OSI (MIZUSHO)</b>			
5892 Table (Top) (Requires 2/unit)	12 Volt / 5.0 Ah	5388	\$25.00
6800, 6850 Table (NV0801) (Requires 2/unit)	12 Volt / 12.0 Ah	5551	\$45.00
Hana Surgical Table (Requires 2/unit)	12 Volt / 12.0 Ah	5551	\$45.00

MEDICAL BATTERIES MFG/MODEL VOLTAGE/CAPACITY R&D PART LIST PRICE

<b>OSI (MIZUSHO) ... continued from previous page</b>			
Spinal Table Jackson 5803 Base (Requires 2/unit)	12 Volt / 12.0 Ah	5551	\$45.00
Spinal Table (Requires 6/unit)	12 Volt / 12.0 Ah	5551	\$45.00

<b>OTODYNAMICS</b>			
Accucheck Martel Printer (MJ09)	4.8 Volt / 1.6 Ah	6192	\$25.00

<b>PACE TECH (CHATILLON, VITAL TECHNOLOGY)</b>			
Blood Pressure Monitor 5042, 602 Vita Trac	6 Volt / 10.0 Ah	5380	\$18.00
CSD-200, CSD-300 Hand Held Stress Meter	6 Volt / .70 Ah	6091	\$35.00
Mini Max CL	6 Volt / 3.0 Ah	5371	\$15.00
Mini Pack 300 Series	12 Volt / 7.0 Ah	5390	\$25.00
Mini Pack 911, 911ST ECG Vital Signs Monitor	6 Volt / 7.0 Ah	5375	\$18.00
Omni 100, 500 Force Gauge OFG500 (NC000157)	7.2 Volt / .70 Ah	5332	\$30.00
Oximax 100 Pulse Oximeter	6 Volt / 3.0 Ah	5371	\$15.00
Oximax 700 Pulse Oximeter	6 Volt / 10.0 Ah	5380	\$18.00
Vitalmax 2000, 2100 Pulse Oximeter	6 Volt / 10.0 Ah	5380	\$18.00
Vitalmax 2200 ECG Monitor	6 Volt / 3.0 Ah	5371	\$15.00
Vitalmax 4000, 4000CL, 4100CL Series	12 Volt / 7.0 Ah	5390	\$25.00
Vitalmax Vital Systems 2, 2N, 4	6 Volt / 10.0 Ah	5380	\$18.00
Vitalmax VSM 500, 800, 2000, 2100, 3000 Monitor	6 Volt / 10.0 Ah	5380	\$18.00
Vital Technology Vitalsign 600, 603, 604 Monitor	6 Volt / 10.0 Ah	5380	\$18.00

<b>PALCO LABORATORIES</b>			
300, 305, 340, 5305 Pulse Oximeter	7.2 Volt / 1.2 Ah	5782	\$32.00
400, 500 Portable Pulse Oximeter	12 Volt / .70 Ah	5781	\$40.00

<b>PARA-TEK</b>			
Portable Nebulizer (Insert Only)	12 Volt / 1.6 Ah	6319	\$105.00

<b>PARKS ELECTRONICS LABS</b>			
Compressor 1102, 1103, 1105, Doppler 1010, Minilab IV 3000	12 Volt / 7.0 Ah	5390	\$25.00
Doppler 1032, 1050, 1052, 1059 Series (Original)	12 Volt / 3.4 Ah	5384	\$25.00
Doppler 1050, 1051, 1052, 1058, 1059, 2014 (Upgrade)	12 Volt / 5.0 Ah	5388	\$25.00
Doppler 611, 811L, 811S, 911S (Requires 2/unit)	6 Volt / 1.2 Ah	5369	\$10.00
Doppler 613, 614, 615, 711, 801B, 808, 811, 812, 821,822, 912, 915	12 Volt / .32 Ah	5186	\$20.00
Doppler 811AL, 811B, 811BL, 811BTS, 811BZ, 811H, 909, 915L,915AL, 915BL, 918, 922	12 Volt / 1.3 Ah	5383	\$18.50
Doppler 917, 918, 922, 8066B	12 Volt / 1.2 Ah	5838	\$20.00
Flo Lab 2016, 2021	12 Volt / 5.0 Ah	5388	\$25.00
Minilab III	12 Volt / 5.0 Ah	5388	\$25.00

<b>PENLON</b>			
AM-1000 Anesthesia Unit	12 Volt / 2.5 Ah	5386	\$20.00
AV-500, AV-5000	3.6 Volt / .15 Ah	5552	\$15.00
AV-80, AV-800	12 Volt / 1.3 Ah	5383	\$18.50

<b>PHILIPS (HEWLETT PACKARD)</b>			
2040A Mida System (2045-60700)	6 Volt / 1.8 Ah	5928	\$40.00
43200, 43200A, 43100A, 43110A, 43120A, 43130A Defibrillator	12 Volt / 2.5 Ah	5205	\$60.00
78333A Monitor	6 Volt / 7.0 Ah	5375	\$18.00
78560 Configuration	3.6 Volt / .70 Ah	5531	\$9.00

**PHILIPS (HEWLETT PACKARD) ... continued from previous page**

78560 Telemetry	7.2 Volt / .65 Ah	5105-I	\$23.00
78571B, 78572 Recorder	7.2 Volt / .180 Ah	5399	\$9.45
78660, 78670A (Clock)	3 Volt / 1.3 Ah	5644	\$9.00
78660A-60401, 78670, 671, 672 Defibrillator	12 Volt / 2.3 Ah	5093	\$149.00
8040, 8040A	4.5 V Duracell PC133A	5400	\$8.25
A-1 BP Monitor (M3923A)	6 Volt / 4.5 Ah	5374	\$12.00
A-3 Vital Signs Monitor (M3928A)	6 Volt / 8.0 Ah	5882	\$36.60
Arrhythmia Monitor 1000 E	2 Volt / 5.0 Ah	5218	\$9.85
Bedside Monitor 40488A	12 Volt / 2.3 Ah	5389	\$40.00
C-1 Patient Monitor	6 Volt / 4.5 Ah	5078	\$16.00
C-3 Patient Monitor	12 Volt / 5.0 Ah	5388	\$25.00
	Codemaster 1722A, 1722B, 1723A, 1723B, 1724A, 1758A, XL Plus (M1758A)	12 Volt / 4.5 Ah	5582 \$40.00
Codemaster 1722A, 1722B, 1723A, 1723B, 1724A, 1758A, XL Plus (Memory)	3 Volt / 1.3 Ah	5644	\$9.00
Codemaster Monitor 100, 2475B (M2476B) (Send in for Retrofit)	12 Volt / 2.5 Ah	5879	\$110.00
Codemaster Monitor 100 (M2477B) (Send in for Retrofit)	12 Volt / 4.0 Ah	5880	\$135.00
Data Management 78534/78554A, 78560, 60040 (Insert)	7.2 Volt / .65 Ah	5105-I	\$23.00
ECG 1504, 1504B, 1505	6 Volt / 3.0 Ah	5371	\$15.00
EKG 4745, 4750, 4755, 4760, 4765A	3.6 Volt / .70 Ah	5180	\$10.00
Fetal Monitor M1350, M1350A, M1350B, M1351, M1353 (Set of 2)	1.5 Volt / 1.0 Ah	5709	\$3.20
ForeRunner 2, FR2, FR2+ (Non-Rechargeable) (M3860A, M3863A) (OEM)	12 Volt / 4.2 Ah	6073	\$263.00
ForeRunner 2, FR2, FR2+ (Non-Rechargeable) (M3860A, M3863A) (OEM)	12 Volt / 4.2 Ah	M3863A	\$263.00
ForeRunner 2, FR2, FR2+ (Non-Rechargeable) (M3863A, M3860A)	12 Volt / 4.2 Ah	6073-A	\$149.00
FRx, Onsite, Home AED (M5070A)	9 Volt / 4.2 Ah	6102-A	\$109.00
HeartStart Forerunner AED (BT1)	18 Volt / 1.3 Ah	5002	\$109.00
HeartStart FR2+ (Rechargeable) (M3848A) (OEM)	12 Volt / 1.6 Ah	6105	\$273.00
HeartStart FR3 (989803150161) (OEM)	12 Volt / 4.2 Ah	6389	\$270.00
HeartStart FRX, Onsite, Home AED (M5070A, M5066A, M5068A) (HS1, MS1) (OEM)	9 Volt / 4.2 Ah	M5070A	\$164.00
HeartStart FRX, Onsite, Home AED (M5070A, M5066A, M5068A) (HS1, MS1) (OEM)	9 Volt / 4.2 Ah	6102	\$164.00
HeartStart MRX (M3536A, M3538A, M3535A) (OEM)	14.8 Volt / 6.0 Ah	6190	\$400.00
	HeartStart XL Defibrillator M4735A (M3561A, M3516A)	12 Volt / 2.3 Ah	5918-A \$40.00
HeartStart XL Defibrillator M4735A (M3561A, M3516A) (OEM)	12 Volt / 2.3 Ah	5918-D	\$108.00
Heartstart XL+ Monitor Defibrillator (989803167281)(OEM)	14.4 Volt / 6.6 Ah	6402	\$350.00

**PHILIPS (HEWLETT PACKARD) ... continued from previous page**



HeartStream Forerunner AED, FR1,  
M2720-64001 (BT1)

18 Volt / 1.3 Ah

5002

\$109.00

Hewlett Packard 78660A-60401, 78670, 671, 672 Monitor  
Defibrillator

12 Volt / 2.3 Ah

5093

\$149.00

Holter Monitor (1420-0349, 1420-0353) (Memory)

3.6 Volt / 1.2 Ah

5231

\$9.00

Intellivue MMS X2, M8004A Patient Monitor (M4607A) (OEM)

10.8 Volt / 1.0 Ah

6303

\$173.00

IntelliVue MP20, 30, 50, 70, M8100, M8001A, M8002A Monitor  
(M4605A, 989803135861)

11.1 Volt / 7.2 Ah

6139-A

\$169.00



IntelliVue MP5, MP20, MP30,  
MP50, MP70, M8100 Monitor  
(M4605A, 989803135861) (OEM)

10.8 Volt / 6.0 Ah

6139

\$369.00

IntelliVue MX40 Wearable Patient Monitor. (989803176201)

11.1 Volt / 1.9 Ah

6440

\$349.00

M13560 (Clock) (2 Battery Set)

1.5 Volt / 1.0 Ah

5709

\$3.20

M2922A, FM2

6 Volt / 4.5 Ah

5078

\$16.00



M3046A, M3056, M2, M3, M4  
Monitor

12 Volt / 3.8 Ah

5963

\$199.00

M3500B, M4000, M5500

12 Volt / 2.3 Ah

5389

\$40.00

M3926A, M3927A, M3929A Portable Monitor

6 Volt / 8.0 Ah

5882

\$36.60

Merlin Monitor M1176A, M1275A, M1276A, M1277A (2/unit)

12 Volt / 2.3 Ah

5389

\$40.00

MX40 (989803174131) (Box of 3 OEM)

3.7 Volt / 1.9 Ah

6443

\$1,018.00

OBMS (80235B) (Clock)

3.6 Volt / .11 Ah

5449

\$11.25

Pagewriter 10, 10i (M3941A)

7.2 Volt / 2.7 Ah

6024

\$48.00

Pagewriter 4700 ECG (Memory)

3.6 Volt / .15 Ah

5552

\$15.00



Pagewriter/ECG1721A-1700 Series,  
XLE, XLI (Panasonic)

18 Volt / 7.2 Ah

5549

\$66.00

Pagewriter II (4745A)

3.6 Volt / .70 Ah

6186

\$10.00

**PHILIPS (HEWLETT PACKARD) ... continued from previous page**

	Pagewriter M1770A-M1772A, 100, 200, 200I, 300PI (M2460A)	6 Volt / 7.2 Ah	5916	\$30.00
	Pagewriter Touch, Pagewriter II (989803129131) (2/unit) (OEM)	10.8 Volt / 7.2 Ah	6140	\$227.00
	Pagewriter Touch, Pagewriter II (989803129131) (Requires 2/unit)	11.1 Volt / 6.0 Ah	6140 A	\$185.00
	Pagewriter Trim III (Insert Only)	12 Volt / 2.9 Ah	6049-I	\$28.00
	Pagewriter Trim I, Trim III (989803130151) (OEM)	12 Volt / 2.9 Ah	6049 B	\$163.00
	Pagewriter Trim I, Trim III (989803130151) (Send in for Retrofit)	12 Volt / 2.9 Ah	6049	\$33.00
	Pagewriter Trim Long Life Battery (989803164611) (OEM)	14.4 Volt / 5.8 Ah	6049-LI	\$512.00
	PMX2000 X-Ray (Requires 10/unit)	12 Volt / 33.0 Ah	5395	\$85.00
	PMX X-Ray (Requires 10/unit)	12 Volt / 18.0 Ah	5391	\$65.00
	Pulsera BV C-Arm, BV300 (Insert, 0819-0020) (26 Battery Set)	312 Volt / 2.5 Ah	6078-I	\$1,040.00
	Pulsera BV C-Arm, BV300 (Send in for Retrofit)	312 Volt / 2.5 Ah	6078	\$1,140.00
	Ram Recorder 78576	3.9 Volt / 7.0 Ah	5580	\$98.00
	Skylight Nuclear Camera Hand Held Controller (NiCd)	4.8 Volt / .70 Ah	6229	\$18.00
	Skylight Nuclear Camera Hand Held Controller (NiMH)	4.8 Volt / 1.65 Ah	6229-NiMH	\$23.00
	Sonos Ultrasound 2500 (Memory)	3.6 Volt / 1.2 Ah	5231	\$9.00
	Sonos Ultrasound Scanner 1000, 5500 (Memory)	3.6 Volt / .11 Ah	5764	\$12.00
	Sonos Ultra Sound Scanner 500, 1000, 77020, 77035A, 77500	3.6 Volt / 2.4 Ah	5506	\$18.00
	Sonos Ultrasound Scanner 5500	12 Volt / 5.0 Ah	5388	\$25.00
	S/Ram PC Board 1046A, M1176A (Merlin)	2.4 Volt / .70 Ah	5710	\$5.60
	Strip Chart Recorder 78640 (M2636C)	6 Volt / 3.0 Ah	5371	\$15.00
	TC30, TC50, TC70 EKG; 860306, 860310, 860315 (989803170371) (OEM)	Use 6343	6401	\$298.00
	TC70 EKG (989803160981) (OEM)	11.2 Volt / 7.2 Ah	6343	\$294.00
	Telemon M2636A/B/C, M4790A	10.8 Volt / 3.8 Ah	5981	\$175.00
	Telemon Telemetry Transmitter 78100A	8.4 Volt / .180 Ah	5398	\$9.45
	Viritia Monitor 1204A, 1205A, 1240 (Requires 2/unit)	12 Volt / 2.3 Ah	5389	\$40.00
	Viritia Transmitter M2601A, Telemetry Transmitter	9 Volt / 1.2 Ah	5868	\$5.95
	VM3, VM4, VM6, VS3 Monitor (989803144631)	11.1 Volt / 7.2 Ah	6181	\$129.00
	VM3, VM4, VM6, VS3 Monitor (989803144631) (OEM)	11.1 Volt / 7.2 Ah	6191	\$268.00
	VS1 Sure Signs Monitor	6 Volt / 5.0 Ah	6014 A	\$48.00

**PHILIPS (HEWLETT PACKARD) ... continued from previous page**

VSi,VS2 Monitor (989803174881)	11.1 Volt / 2.3 Ah	6438	\$82.00
--------------------------------	--------------------	------	---------

**PHS West**

Ergo Express PTC1 (Requires 2/unit)	12 Volt / 40.0 Ah	NPX-150RFR	\$190.00
-------------------------------------	-------------------	------------	----------

**PHYSIO-CONTROL (FIRST MED, MEDTRONIC)**

200 Biopak (Requires 2/unit)	12 Volt / 7.0 Ah	5390	\$25.00
------------------------------	------------------	------	---------



CR Plus, Express Charge Pak (11403-000002) (OEM)	12.0 Volt / 1.5 Ah	6110	\$88.00
---	--------------------	------	---------

EDGE System electrodes with QUIK-COMBO connector and REDI-PAK preconnect system	EDGE System Electrodes / REDI-PAK	11996-000017	\$49.00
---	-----------------------------------	--------------	---------

First Medic 510, 550, 610 Defibrillator	12 Volt / 2.3 Ah	5387	\$45.00
---	------------------	------	---------

First Medic 710 Defibrillator	12 Volt / 2.0 Ah	5771	\$42.00
-------------------------------	------------------	------	---------

Lifecap Capnograph (Send in for Retrofit)	7.2 Volt / 2.7 Ah	5914	\$60.00
---	-------------------	------	---------

Life Net STM (Requires 3/unit)	6 Volt / 1.0 Ah	5368	\$9.00
--------------------------------	-----------------	------	--------



Lifepak 1000 AED Defibrillator (11141-000100) (OEM)	12 Volt / 4.5 Ah	6118	\$334.00
--	------------------	------	----------

Lifepak 12 FP2 Fastpak NiCd (11141-000044, 09-10424)	12 Volt / 1.9 Ah	5931-A	\$80.00
--	------------------	--------	---------

Lifepak 12 FP2 Fastpak NiCd (11141-000044, 09-10424)	12 Volt / 1.2 Ah	5931	\$60.00
--	------------------	------	---------

Lifepak 12 HighPak Li-Ion (11141-000106)	12 Volt / 7.2 Ah	6285	\$415.00
--	------------------	------	----------



Lifepak 12 NiCd Nickel Cadmium Version (11141-000149, 11141-000025) (OEM)	12 Volt / 1.6 Ah	6010 A	\$310.00
--	------------------	--------	----------



Lifepak 12 SLA Sealed Lead Acid Version (11141-000028, 3009378) (OEM)	12 Volt / 2.5 Ah	6005	\$233.00
---	------------------	------	----------

Lifepak 12 SLA (Send in for Retrofit/Exchange)	12 Volt / 2.5 Ah	6005-R	\$145.00
--	------------------	--------	----------

Lifepak 15 Monitor Defibrillator (21330-001176, 3206735-001) (Li-Ion) (OEM)	11.1 Volt / 5.7 Ah	6308	\$432.00
--	--------------------	------	----------



Lifepak 20 (11141-000068, 3200497-000)	12 Volt / 3.0 Ah	5042	\$125.00
---	------------------	------	----------



**PHYSIO-CONTROL (FIRST MED, MEDTRONIC) ... continued from previous page**

	Lifepak 20e (11141-000112, 3205296-002) (Li-Ion) (OEM)	10.8 Volt / 6.0 Ah	6341	\$281.00
	Lifepak 20 (Memory) (202305-000)	3.0 V Lithium	5884	\$3.25
	Lifepak 250 Defibrillator (Requires 2/unit)	12 Volt / 1.8 Ah	5027	\$48.00
	Lifepak 300 Defibrillator (Send in for Retrofit)	12 Volt / 3.4 Ah	5622	\$49.50
	Lifepak 5	12 Volt / 1.8 Ah	5027	\$48.00
	Lifepak 500 (Non-Rechargeable)	12 Volt / 7.5 Ah	6019	\$185.00
	Lifepak 500 (Non-Rechargeable) (11141-000013, 3005380-026, 11141-000158) (OEM)	12 Volt / 7.5 Ah	6100	\$297.00
	Lifepak 500 (Rechargeable) (11141-000002, 3005379-000) (OEM)	8 Volt / 2.5 Ah	6109	\$195.00
	Lifepak 500 (Rechargeable) (Send in for Retrofit)	8 Volt / 2.5 Ah	5953	\$56.00
	Lifepak 5 Fast Pak, LifePak 10, 11 Defibrillator	12 Volt / 1.8 Ah	5027 FP	\$50.00
	Lifepak 6, 6S, 7 Defibrillator	12 Volt / 1.8 Ah	5028	\$49.00
	Lifepak 6, 6S, 7 Monitor VSM2 Monitor, ECG	14.4 Volt / 2.3 Ah	5029	\$68.00
	Lifepak 6, 6S, 7 Recorder (Clock)	3.6 Volt / 1.2 Ah	5231	\$9.00
	Lifepak 8 Defibrillator (2 Battery Set)	12 Volt / 1.2 Ah	5238	\$70.00
	Lifepak 8 Monitor (2 Battery Set)	19.2 Volt / 2.3 Ah	5201	\$100.50
	Lifepak 8 Recorder (Clock)	3.6 Volt / 1.2 Ah	5231	\$9.00
	Lifepak 9 Monitor Defibrillator (803704-03) (EnerSys)	16 Volt / 2.5 Ah	5725	\$90.00
	Lifepak 9 Monitor Defibrillator (Powersonic)	16 Volt / 3.2 Ah	5214-P	\$55.00

**PHYSIO-CONTROL (FIRST MED, MEDTRONIC) ... continued from previous page**



Lifepak 9 Monitor Defibrillator  
(Sonnenschein)

16 Volt / 2.7 Ah 5214 \$116.00

Life Stat 100 BP Monitor	8 Volt / 2.5 Ah	5187	\$33.00
Life Stat 200 BP Monitor, Life Stat 1600 Pulse Oximeter	8 Volt / 2.5 Ah	5130	\$43.00
Life Stat 200 (Clock)	3.6 Volt / .11 Ah	5449	\$11.25
Medtronic Actrac 100/Tracker Simulator	3.9 Volt / 2.0 Ah	5806	\$57.00
Medtronic Blood Pump 540, 550 (Requires 2/unit)	12 Volt / 7.0 Ah	5390	\$25.00
Medtronic Hemo Pump	12 Volt / 2.3 Ah	5387	\$45.00
Tens Unit (89002005)	7.2 Volt / .180 Ah	5399	\$9.45
TonoPen, XL TonoMeter	3 V Lithium	5869	\$3.00
VSM-2 Circuit Board (Clock)	3.6 Volt / .11 Ah	5449	\$11.25
VSM-3 Cardiac Monitor (Requires 2/unit)	6 Volt / 1.2 Ah	5369	\$10.00
VSM-1 Monitor	18 Volt / 2.5 Ah	5147	\$86.00

**PHYSIOMED**

Hivamat 200 Muscle Stimulator (Send in for Retrofit)	7.2 Volt / 1.8 Ah	6335	\$30.00
--	-------------------	------	---------

**PPG BIOMEDICAL SYSTEMS (LITTON-DATAMEDIX)**

Bactec O2 Analyzer	3.6 Volt / .15 Ah	5552	\$15.00
EK31, EK32, EK33, 43 EKG Monitor	6 Volt / 3.0 Ah	5371	\$15.00
PD500, PD505, PD506 Monitor Defibrillator	12 Volt / 2.3 Ah	5011	\$97.00
PM2-B EKG Monitor (Requires 2/unit)	8 Volt / 2.5 Ah	5051	\$36.00
Sara Amber Monitor	12 Volt / 2.9 Ah	5385	\$29.00
Sara Cap OR, OR Plus Gas Analyzer	7.2 Volt / .65 Ah	5608	\$35.00

**PRECISION MEDICAL**

PM65 Easy Go Vac Aspirator	12 Volt / 2.9 Ah	5969	\$38.00
----------------------------	------------------	------	---------

**PROPPER MANUFACTURING**

2.5 Magalume (199119)	2.4 Volt / .750 Ah	5135	\$17.50
3.5 Superlume (199121)	3.6 Volt / .75 Ah	5097	\$19.50
Otoscope	3.6 Volt / .75 Ah	5097	\$19.50

**PROTOCOL SYSTEMS**



Encore 102EL, 106EL, 202EL,  
204EL, 206EL, 240EL, 242EL,  
244EL, 246EL Propaq Monitor  
101-106 (EL) Double Battery with  
Printed Circuit Board, Expansion  
Printer Option (501-0006-00,  
501-0008-00, 008-0125-00)  
(Powersonic)

8 Volt / 6.4 Ah 5503-P \$60.00



**PROTOCOL SYSTEMS ... continued from previous page**



Encore 102EL, 106EL, 202EL, 204EL, 206EL, 240EL, 242EL, 244EL, 246EL Propaq Monitor 101-106 (EL) Double Battery with Printed Circuit Board, Expansion Printer Option (501-0006-00, 501-0008-00, 008-0125-00) (Sonnenschein)

8 Volt / 5.4 Ah 5503 \$124.00

Propaq Monitor 101-106 (EL) Single Battery with Printed Circuit Board (Powersonic) (501-0007-01)

8 Volt / 3.2 Ah 5925-P \$40.00



Propaq Monitor 101-106 (EL) Single Battery with Printed Circuit Board (Sonnenschein) (501-0007-01)

8 Volt / 2.7 Ah 5925 \$62.50

Propaq Monitor Single Battery (Powersonic)

8 Volt / 3.2 Ah PS-832 \$25.00



Propaq Monitor Single Battery (Sonnenschein)

8 Volt / 2.7 Ah 5275 \$54.00

**PULMONETIC SYSTEMS**

LTV 1200 Ventilator (Internal)	12 Volt / 4.5 Ah	6212	\$50.00
LTV 900, 950, 1000 Ventilator (Internal)	12 Volt / 4.5 Ah	5117	\$50.00
LTV 950, 1000 II Ventilator (11475) (External)	12 Volt / 12.0 Ah	5551	\$45.00
LTV 950 Transport	12 Volt / 33.0 Ah	5395	\$85.00
LTV Universal Power Supply (14546-001)	12 Volt / 20.0 Ah	6040	\$88.00

**PURITAN BENNETT (INFRASONICS, NELLCOR)**

240 Monitor (Requires 2/unit)	6 Volt / 1.2 Ah	5369	\$10.00
740, 742, 760 Ventilator (External) (G016113900) (Requires 2/unit)	12 Volt / 18.0 Ah	5391	\$65.00



740, 742, 760 Ventilator System (Internal)(G016113900)

24 Volt / 7.2 Ah 5956 \$96.00

7950 Ventilator Alarm	8.4 Volt / .180 Ah	5398	\$9.45
840 Ventilator System (10025355) - 4 Hour	24 Volt / 18.0 Ah	6400	\$195.00

**PURITAN BENNETT (INFRASONICS, NELLCOR) ... continued from previous page**



840 Ventilator System  
(4-070523-SP) - 2 Hour

24 Volt / 7.0 Ah      5110      \$71.50

Clinivision MPC Handheld	3 Volt / .016 Ah	5036	\$4.00
Nightstar 330	12 Volt / 7.0 Ah	5390	\$25.00
PB100, PB110 Renaissance I Spirometer	3.6 Volt / .70 Ah	5677	\$15.00
PB700 Renaissance II Spirometer (P-495219-000)	4.8 Volt / .70 Ah	5069	\$18.00
Suzanne Recorder Plus	7.2 Volt / 4.0 Ah	5176	\$65.00

**QMED**

Interp 1000 EKG	12 Volt / 1.2 Ah	5838	\$20.00
-----------------	------------------	------	---------

**QUEST MEDICAL INC. (DYNATECH NEVADA)**

1001, 2001 Infusion Pump	6 Volt / 3.0 Ah	5371	\$15.00
521 Infusion Pump	6 Volt / 3.0 Ah	5371	\$15.00
521 Plus Infusion Pump	6 Volt / 4.5 Ah	5374	\$12.00
MTP, MVP, MVP-1 Infusion Pump	6 Volt / 4.5 Ah	5374	\$12.00

**QUINTON (BURDICK)**

2020D (Memory)	3 Volt / .240 Ah	5343	\$4.50
2720 (Memory)	3 Volt / 1.5 Ah	5605	\$9.00
710S, Q710, 750B (Requires 4/unit)	6 Volt / 3.4 Ah	5675	\$29.00
750 EKG	6 Volt / 3.4 Ah	5675	\$29.00
Porta Fib 3, 617D Monitor Defibrillator	24 Volt / 1.8 Ah	5312	\$130.00
Q4000, 5000 (Memory)	3.5 Volt / 1.5 Ah	5939	\$28.00
Quick Prep Applicator	4.8 Volt / .70 Ah	5472	\$12.50

**RACAL**

Air-Mate Breathe Easy BP15 (OEM)	4.8 Volt / 7.0 Ah	5919	\$445.00
----------------------------------	-------------------	------	----------

**RADIOMETER AMERICA**

Blood Gas Analyzer ABL 77	14.4 Volt / 4.0 Ah	6041	\$115.00
Oxy-1, Oxy-3, Oxy-13 Pulse Oximeter (2 Battery Set)	12 Volt / 1.2 Ah	5639	\$24.00
TCM-3 Monitor, OXY-3 Pulse Oximeter (External)	12 Volt / 2.9 Ah	5385	\$29.00
TCM-3, TCM30 CO2 Cutaneous Monitor (Internal) (Insert)	7.2 Volt / 2.3 Ah	5518-I	\$30.00
TCM-3, TCM30 CO2 Cutaneous Monitor (Internal) (Retrofit)	7.2 Volt / 2.3 Ah	5518	\$35.00
TCM-4 CO2 Cutaneous Monitor	12 Volt / 2.3 Ah	5389	\$40.00

**RADIONICS**

Sterotactic Neurosurgical Computer, SCS-1, 1-1900	4.8 Volt / 1.8 Ah	5815	\$40.00
Thermo Couple Adapter TCA-1 (Requires 4/unit)	4 Volt / 1.0 Ah	5396	\$35.00

**RAININ**

EDP Plus Pipette	4.8 Volt / .225 Ah	6120	\$12.00
------------------	--------------------	------	---------

**RAULAND BORG**

3000 Nurse Call	12 Volt / 7.2 Ah	5780	\$34.00
Nurse Call, III, Responder III, BK2000 (401907-105)	14.4 Volt / 1.8 Ah	5705	\$55.00
Nurse Call, III, Responder III, BK2000 (NIC0026) (401907-105) -OR-	12 Volt / 1.8 Ah	5263	\$37.00
Nurse Call R4000 (BD0111)	16.8 Volt / 1.8 Ah	6051	\$49.00
Responder IV,(BD0109)	14.4 Volt / 1.8 Ah	5063	\$55.00
Tracer System RHV210, RHE220, 330	3.5 Volt / .750 Ah	6017	\$18.00

**RESPIRONICS (LIFECARE, HEALTHDYNE)**

2500 Smart recorder (H2502)	7.2 Volt / .70 Ah	6420	\$30.00
900 Series Smart Monitor	6 Volt / 2.3 Ah	5492	\$35.00
Bilichek (Send in for Retrofit)	6 Volt / .70 Ah	6090	\$35.00
BiPAP Focus Ventilator (8-500016-00)	9.6 Volt / 3.8 Ah	6137	\$95.00
BiPAP Vision (1006005) (Memory)	2.8 V Timekeeper	6315	\$15.00
BiPAP Vision (1012819) (Memory)	3.6 Volt / .11 Ah	5449	\$11.25
Criterion 40, 60 Monitor	6 Volt / 1.6 Ah	6038	\$30.00
Esprit Ventilator (1001470) (Insert)	24 Volt / 8.0 Ah	5090-I	\$203.00
Esprit Ventilator (External) (Requires 2/unit)	12 Volt / 35.0 Ah	6258	\$125.95



Esprit Ventilator (Internal)  
(Send in for Retrofit)

24 Volt / 8.0 Ah	5090	\$215.00
------------------	------	----------

Freeway Nebulizer (Requires 2/unit)	6 Volt / 3.0 Ah	5371	\$15.00
ISL 100 Transilluminator	7.2 Volt / 1.8 Ah	5641	\$30.00
NICO2 Monitor	12 Volt / 2.3 Ah	6284	\$20.00
Nite Owl	7.2 Volt / 1.4 Ah	5934	\$38.00
PLV100, 102 (Alarm)	3.6 Volt / .15 Ah	5552	\$15.00
PLV100, 102 Ventilator (2 Battery Set)	12 Volt / 2.5 Ah	5543	\$93.75
Pulse OX 710508AZ, Pulse OX100	6 Volt / 1.2 Ah	5369	\$10.00



Smart Monitor 2, 4003 (418)  
(460009-027)

6 Volt / 2.1 Ah	5996	\$45.00
-----------------	------	---------

V200 Ventilator (1059956) (Retrofit)	24 Volt / 8.0 Ah	6396	\$215.00
Whisperflow	6 Volt / 1.6 Ah	5973	\$30.00

**REVCO**

Blood Bank Refrigerator Backup	12 Volt / 1.0 Ah	5318	\$19.00
Freezer Backup Alarm, Legaci	12 Volt / 1.3 Ah	5383	\$18.50

MEDICAL BATTERIES MFG/MODEL VOLTAGE/CAPACITY R&D PART LIST PRICE

**RIGEL**

Multi Care Monitor 304, 309 (Requires 2/unit)	6 Volt / 3.0 Ah	5371	\$15.00
---	-----------------	------	---------

**RN PLUS (NURSE ASSIST, INC.)**

RN Plus Bed Alarm	8.4 Volt / .180 Ah	5398	\$9.45
RN Plus Signal Unit	7.2 Volt / .70 Ah	6055	\$34.00

**ROCHE**

Accu-Chek-Inform Blood Glucose Monitoring System(1UF103450P-RV)	3.7 Volt / 1.8 Ah	6298	\$44.00
---	-------------------	------	---------

**RUBBERMAID**

Medicine Cart (FG9M0908MB)	7.2 Volt / 2.5 Ah	6306	\$42.00
----------------------------	-------------------	------	---------

**SABRATEK (BAXTER)**

3030 Infusion Pump	12 Volt / 3.4 Ah	5667	\$41.00
3030 Infusion Pump (Internal) (Clock)	3 Volt / .165 Ah	5913	\$4.25
3030 Infusion Pump (Memory)	4.8 Volt / .70 Ah	5602	\$9.50
6060 Alarm (Memory)	3.6 Volt / .15 Ah	6050	\$6.00

**SAMMONS PRESTON**

Roylan Scandmed Tourniquet 5529 (7000003) (Insert)	12 Volt / 1.2 Ah	6278-I	\$190.00
Roylan Scandmed Tourniquet 5529 (7000003) (Send in for Retrofit)	12 Volt / 1.2 Ah	6278	\$195.00

**SANDOZ (NOVARTIS)**

Compat Enteral Feeding Pump 199225, 199235	12 Volt / 1.2 Ah	5838	\$20.00
--	------------------	------	---------

**SANYO**

Ultra Low Freezer VIP Plus (MDF-C8V)	6.0 Volt / 1.6 Ah	6445	\$35.00
--------------------------------------	-------------------	------	---------

**SCALE-TRONIX, INC.**

Bed Scale 2500 (Requires 4/unit)	6 Volt / 1.2 Ah	5369	\$10.00
Scale 48, 2001, 2009, 2700, 4004, 4800, 4802, 5005, 5700,	6 Volt / .70 Ah	5140	\$15.00
Scale 5002, 5702, 6100, 6102 (360007, 360002-20009)	7.2 Volt / 1.8 Ah	6006	\$35.00
Wheelchair Scale 6002	1.5 V Alkaline	5408	\$0.80

**SCHAERER MAYFIELD**

7100, 7300 OR Table (Requires 4/unit)	12 Volt / 10.0 Ah	6018	\$88.00
---------------------------------------	-------------------	------	---------

**SCHILLER AMERICA (WELCH ALLYN)**

Argus VCM Monitor	6 Volt / 4.5 Ah	5374	\$12.00
AT-10 EKG Machine (AMP, Round Socket) (Requires 2/unit)	12 Volt / 0.8 Ah	5785	\$22.00
AT-1 EKG Machine	12 Volt / 1.3 Ah	5383	\$18.50
AT-2, AT2 Plus EKG, AT102, PT60 (53017-00-00)	12 Volt / 2.5 Ah	5515	\$20.00
AT-4, AT-5 EKG Machine	9.6 Volt / 1.6 Ah	5824	\$60.00
AT-6, AT-60 Portable EKG	12 Volt / 2.5 Ah	5386	\$20.00
CS-2000 Stress Test (Requires 2/unit)	12 Volt / 0.8 Ah	5895	\$22.00
SP-10 Spirometer (JST, Square Socket) (Requires 2/unit)	12 Volt / 0.8 Ah	5895	\$22.00
SP-1 Spirometer	12 Volt / 1.3 Ah	5383	\$18.50
SP-200 Spirometer	12 Volt / 2.5 Ah	5515	\$20.00

<b>SCHUCO, INC. (ALLIED HEALTHCARE, GOMCO)</b>			
135 Portable Suction Unit	12 Volt / 12.0 Ah	5551	\$45.00
138 Aspirator (5711-135) (Requires 2/unit)	12 Volt / 7.0 Ah	5390	\$25.00
160A Suction Unit (Requires 2/unit)	6 Volt / 12.0 Ah	5377	\$22.00
G178, L178, S178, 180 Series Aspirator, Opti Vac, SU1060, 4005	12 Volt / 5.0 Ah	5388	\$25.00
Omni Vent Series Ventilator	9 Volt / 1.2 Ah	5868	\$5.95
Opti Vac L190	12 Volt / 3.4 Ah	5667	\$41.00

<b>SEBRA (BAXTER)</b>			
Tube Sealer 1070	12 Volt / 7.0 Ah	5390	\$25.00
Tube Sealer 1071	12 Volt / 26.0 Ah	5393	\$67.00
Tube Sealer 2380	12 Volt / 2.4 Ah	5762	\$65.00

<b>SECA</b>			
Chair Scale 644, 708, 728, 736, 944, 964 Stand Up Scale	7.2 Volt / .70 Ah	5784	\$23.00
Pediatric Scale 220, 229, 706	7.2 Volt / 1.6 Ah	5784-NiMH	\$28.00
Pediatric Scale 727	9.6 Volt / .70 Ah	5736	\$26.00

<b>SECHRIST INDUSTRIES</b>			
100B Infant Ventilator (Requires 2/unit)	7.2 Volt / .180 Ah	5399	\$9.45
Millennium Ventilator (HR4/5AV-F52PC)	12 Volt / 2.1 Ah	6023	\$80.00

<b>SEIKO INSTRUMENTS</b>			
BP4005 Printer	4.8 Volt / 1.6 Ah	5079	\$25.00

<b>SENCORE (BAPCO)</b>			
PS97 Patient Simulator (17832 Rev. B)	6 Volt / 4.0 Ah	5183	\$35.00

<b>SENSOR MEDICS (CRITIKON, GOULD)</b>			
ELI-XR, ELI-100, ELI-200	6 Volt / 1.0 Ah	5368	\$9.00
Microgas 7650	12 Volt / 2.5 Ah	5515	\$20.00
SAT-TRAK Pulse Oximeter	7.2 Volt / 2.0 Ah	5734	\$45.00

<b>SEPARATION TECHNOLOGIES</b>			
HemataSTAT II, HemaSTAT Easy Read	14.4 Volt / .70 Ah	5873	\$40.00

<b>SERVOX (JEDCOM, ROMEX)</b>			
Artificial Voice Box (NiMH)	7.2 Volt / .20 Ah	5669-NiMH	\$16.50



<b>SHERWOOD MEDICAL (CHESEBROUGH-PONDS, FILAC)</b>			
5-7905, 5-7920 Resprodyne Pulmonary Monitor	7.2 Volt / .110 Ah	5208	\$19.00
5-7930, R2, R2 Plus Resprodyne Pulmonary Monitor	7.2 Volt / .20 Ah	5354	\$19.00
5-7935 Printer	4.8 Volt / .70 Ah	5150	\$12.00



Intriflush K524, Kangaroo Feeding Pump 224, 324

7.2 Volt / 1.8 Ah	5284	\$24.00
-------------------	------	---------

**SHERWOOD MEDICAL (CHESEBROUGH-PONDS, FILAC) ... continued from previous page**

	Kangaroo (Control), Pet Ambulatory Pump	7.2 Volt / 1.6 Ah	5070	\$35.00
	Kangaroo E Pump (F010484)	4.8 Volt / 3.8 Ah	6094	\$40.00
	Kangaroo Feeding Pump 200, 220, 300, 330	12 Volt / 1.8 Ah	5158	\$47.00
	Kangaroo Feeding Pump 2, 22 (1 hr.) (Requires 2/unit)	12 Volt / .70 Ah	5199	\$37.00
	Kangaroo Feeding Pump 2, 22 (3 hr.)	12 Volt / 1.8 Ah	5268	\$57.00
	Kangaroo Pet Pump	3.6 Volt / 1.7 Ah	5626	\$22.00
	Kangaroo Pet Pump, Pet Ambulatory Pump	3.6 Volt / 1.7 Ah	5626	\$22.00
	Kangaroo Pump 224, 324 - Enhanced (010263) (New Revision)	7.2 Volt / 1.6 Ah	5997	\$30.00
	Kangaroo Pump 624	7.2 Volt / 1.6 Ah	6048	\$35.00
	Thermometer 1500 (P.C. Board Mount)	6 Volt / 1.7 Ah	5292	\$16.80
	Thermometer 1500 (Wire Connector)	6 Volt / 1.7 Ah	5349	\$17.00

**SHIMADZU**

Mobile Cart, MUX100, MUX100D (Requires 20/unit)	12 Volt / 9.0 Ah	UP-VW1245P1	\$39.00
Mobile WFLNC-125 (Requires 2/unit)	12 Volt / 33.0 Ah	5395	\$85.00

**SIEMENS MEDICAL SYSTEMS (QUANTUM, SERVOX, BURDICK)**

3000, SC6000, SE6000, 6002, SC6002XL Monitor	12 Volt / 2.0 Ah	5771	\$42.00
341 Transport Monitor, XP Mobile Lift (Requires 2/unit)	6 Volt / 3.0 Ah	5371	\$15.00
350 Transport Monitor (Requires 2/unit)	12 Volt / 7.0 Ah	5390	\$25.00
732 Monitor (Memory)	3.6 Volt / 1.2 Ah	5084 A	\$9.00
Mobilet Plus HP X-Ray (6639327) (Sonnenschein, Requires 16/unit)	12 Volt / 10.0 Ah	6018	\$88.00
Multi IO (Memory)	3 Volt / 1.2 Ah	5735	\$9.00
Ophthalmoscope Pre-Vista (CJB-191) (77mm)	3.6 Volt / .75 Ah	6221	\$25.00
Ophthalmoscope Vista (1919-P-7069) (81mm)	3.6 Volt / .75 Ah	6220	\$25.00
SC6002XL, SC6802XL, SC7000, 9000XL (Li-Ion) (External)	14.4 Volt / 4.4 Ah	6059	\$179.00
SC7000, 9000XL (External)	12 Volt / 2.3 Ah	5389	\$40.00
SC7000, 9000XL (Internal)	12 Volt / 3.4 Ah	5667	\$41.00
SC9000 Physiologic Monitor	12 Volt / 1.2 Ah	5861	\$75.00
SC9000 Transport (4319344)	12 Volt / 5.0 Ah	5910	\$120.00
Servo 300, 390 (Memory)	3.6 Volt / 2.5 Ah	5952	\$11.00
Servo 300 Ventilator Accumulator (Panasonic) (Requires 2/unit)	12 Volt / 2.2 Ah	5991	\$27.00
Servo 300 Ventilator Accumulator (Sonnenschein) (2/unit)	12 Volt / 2.0 Ah	5992	\$55.00

**SIEMENS MEDICAL SYSTEMS (QUANTUM, SERVOX, BURDICK) ... continued from previous page**

Servo-I, Servo-S, Adult, Infant, Universal (06194687) (Memory)	3.6 Volt / 2.5 Ah	5952	\$11.00
Servo-I, Servo-S Module (64 87 180) (OEM)	12 Volt / 4.0 Ah	5058	\$445.00
Sirecust 454 Pressure Module 70, 73, 109	3 Volt / .165 Ah	5483	\$3.90
Sirecust 630 Portable Monitor (Save Original Wire Harness)	8 Volt / 2.7 Ah	5275	\$54.00
Sonline Antares Ultrasound, S-2000 (4834789)	4.8 Volt / 4.5 Ah	6289	\$45.00
Surgical Table, 113001D OR Table Remote Control	12 Volt / 12.0 Ah	5551	\$45.00
Symphony MRI (Magnetic) (Requires 2/unit)	12 Volt / 2.5 Ah	5515	\$20.00

**SIGMA**

4000 Infusion Pump	12 Volt / 7.0 Ah	5390	\$25.00
5000 Infusion Pump (Requires 2/unit)	6 Volt / 3.0 Ah	5371	\$15.00
6000, 6000 Plus, 7000, 7200 Infusion Pump	12 Volt / 3.2 Ah	5679	\$36.75
6000 Dual Pump (Memory)	12 Volt / 1.2 Ah	5838	\$20.00
8000, 8000 Plus Infusion Pump	12 Volt / 2.5 Ah	5896	\$56.00
8000 Infusion Pump (Memory)	3.6 Volt / 1.2 Ah	5466	\$9.00
8002, 8002 Plus Infusion Pump (460005-129)	12 Volt / 4.5 Ah	6007	\$95.00
SIO-TEC Portable Suction Unit	12 Volt / 1.3 Ah	5383	\$18.50
Spectrum Infusion Pump (35702, 35724) Standard Battery - Non-Wireless Complete With Case	7.2 Volt / 2.0 Ah	6296	\$66.50

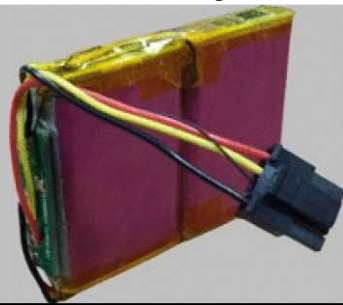

Spectrum Infusion Pump - Insert Only (55075-2, 35083, 35162, 35700, 35724)

7.2 Volt / 2.0 Ah	6296-I	\$46.50
-------------------	--------	---------

**SIGNTEX INC.**

MLW Series (206129)	4.8 Volt / 5.0 Ah	6413	\$42.00
---------------------	-------------------	------	---------

**SITE MICRO SURGICAL SYSTEMS (DYMAX)**

Binocular Ophthalmoscope	2.4 Volt / 1.8 Ah	5124	\$13.00
Lightsource (1919-P-5063)	6 Volt / 1.8 Ah	5103	\$32.00
Medic Lux (1919-P-5020)	3.6 Volt / .75 Ah	5097	\$19.50
Regular Site Machine	8 Volt / 3.5 Ah	5382	\$49.00
Site-Rite 5, Site-Rite 6	11.1 Volt / 7.2 Ah	6181	\$129.00
Site-Rite III, IV (8000160741, 800113B01) (Insert)	14.4 Volt / 4.5 Ah	5060-I	\$120.00
Site-Rite III, IV (8000160741, 800113B01) (Send in for Retrofit)	14.4 Volt / 4.5 Ah	5060	\$125.00
Site-Rite, II, Ultrasound 8000 (8001 C0775) (Send in for Retrofit)	14.4 Volt / 2.3 Ah	5794	\$95.00

**SKYTRON**

3500B, 3600B, 6001, 6700 Elite OR Table (Requires 2/unit)	12 Volt / 18.0 Ah	5391	\$65.00
6100 Elite OR Table (Requires 2/unit)	12 Volt / 12.0 Ah	5551	\$45.00
6500 Elite OR Table (Requires 2/unit)	12 Volt / 18.0 Ah	5391-F2	\$65.00
OP1900 Table (Requires 2/unit)	12 Volt / 7.2 Ah	5780	\$34.00

**SMITH & NEPHEW CO.**

Exogen 4000+ Bone Healer (Ultrasound) (81025147, Rev. A)	18 Volt / 2.1 Ah	6395	\$45.00
--	------------------	------	---------





**SPECTRALINK ... continued from previous page**

BPL100, BPL200, BPL300, 8020, 8030, BPL100, LINK 6020, LINK 8020, LINK 8030	3.7 Volt / 2500 mAh	BATT-BPL300	\$65.00
BPN100, BPE100, Netlink 340	3.6 Volt / 730 mAh	BATT-3616	\$70.00
BPX100, I640, Netlink I640, PTX110, RNP2400	3.6 Volt / 730 mAh	BATT-BPX100	\$50.00
NBTB410, PT360, PT400, PTB400, PTB410A, PTB410R, PTS330, PTS360, PTS400, SKPT400, SPT360, SPT400	4.8 Volt / 730 mAh	BATT-360	\$40.00

**SPIROLAB**

Spirolab II, Spirolab III (Save Original Connector)	7.2 Volt / 4.5 Ah	6052	\$60.00
---	-------------------	------	---------

**SPIROMETRICS INC.**

Flomate 2400, 2453 Spirometer -OR-	3.6 Volt / .15 Ah	5457	\$10.00
Flomate 2500, 2500LTE	3.6 Volt / .11 Ah	5886	\$15.00

**SPO MEDICAL**

Pulse Ox 5500, 6000 Checkmate	3.6 Volt / 1.2 Ah	5437	\$9.00
-------------------------------	-------------------	------	--------

**SSCOR INC.**

10552A, 15002, 15002A (80133 PV, FV)	12 Volt / 5.0 Ah	6174	\$26.00
--------------------------------------	------------------	------	---------



2014, 2300, 2310, 2314, 2314B  
Suction Unit Duet, Ten (80634, 80635)

2315 Suction Unit, 74000 (80638)	12 Volt / 2.8 Ah	6173	\$32.00
2403 Suction Unit (80613)	13.5 Volt / 2.0 Ah	6398	\$22.00
2500 Sentinel, 2014A, 2100, 2100A, 2500, Ten, Suction Unit (80636)	12 Volt / 2.9 Ah	6175	\$29.00
30001, 30002, 40002 (Save Original Connector)	12 Volt / 5.0 Ah	5104	\$57.00
30011, 30012, 40012, 40013, AE-6955	12 Volt / 7.0 Ah	5390	\$25.00
64000 (80633-1)	12 Volt / 2.8 Ah	5598	\$32.00
90021, SScor2	12 Volt / 4.0 Ah	5818	\$22.00
90024, 90024A, 90024B, 90032 (80133 PV, FV)	12 Volt / 5.0 Ah	6174	\$26.00



AD-700, AD-3000 Pulse Oximeter,  
CapnoCheck

AD-900, AD-2000 Pulse Oximeter	6 Volt / 1.2 Ah	5369	\$10.00
Pac Vac, Fast Vac, S-Scort Jr., S-Scort 2, 90012	12 Volt / 4.0 Ah	5417	\$25.00
Quickdraw 2400, 2400-230, 2401, 2402 (80611)	12 Volt / 0.5 Ah	6141	\$60.00
S-Scort 3	12 Volt / 2.8 Ah	6205	\$30.00

**SSCOR INC. ... continued from previous page**



S-Scort 3  
\*May use either 5598 or 6205\*

12 Volt / 2.8 Ah      5598      \$32.00

S-Scort 4, 40014, 45000 (80033-10)      12 Volt / 7.0 Ah      6176      \$26.00

S-Scort 9, 2109 (80637)      12 Volt / 2.9 Ah      6227      \$26.00

TEN Portable Suction (80635-100) For serial numbers under 3000 or starting with AG or AJ      12 Volt / 2.8 Ah      5052      \$32.00

TEN Portable Suction (80636-100) For serial numbers over 3000 or starting with P or R      12 Volt / 2.9 Ah      6175      \$29.00

Vacstat Portable Suction Unit      12 Volt / 7.0 Ah      5390      \$25.00

**STEREO OPTICAL COMPANY (COPELAND OPTEC)**

360 Retnascope (360-128, 360-129)      2.4 Volt / .70 Ah      5621      \$15.00

360 Retnascope (360-H11)      3.6 Volt / .27 Ah      5738      \$23.00

360 Streak Largoscope (360-H1) (CJB360R)      3.6 Volt / .27 Ah      5909      \$23.00

CJB224      4.8 Volt / .75 Ah      5640      \$26.00

**STERIS (ALSO SEE AMSCO)**

C-Max Surgical Table (Requires 2/unit)      12 Volt / 26.0 Ah      5393      \$67.00

EPC 250 (Requires 4/unit)      12 Volt / 1.3 Ah      5383      \$18.50

ESC Surgical Chair (Requires 2/unit)      12 Volt / 1.3 Ah      5383      \$18.50

Hall Arthroscope      12 Volt / 2.9 Ah      5385      \$29.00

Sterilizer 2047 (Requires 4/unit)      6 Volt / 3.2 Ah      5373      \$22.00



Surgical Table 3080 RC / 3080 RL,  
3080SP, 3085, 3085SP Motor  
Battery - New Revision (Requires  
2/unit)

12 Volt / 28.0 Ah      5850      \$110.00



Surgical Table 3080 RC / 3080 RL,  
3080SP, 3085 (P136806806) Motor  
Battery  
- Original Version (Requires 2/unit)

12 Volt / 26.0 Ah      5393      \$67.00

**STERIS (ALSO SEE AMSCO) ... continued from previous page**



Surgical Table 3080 RC / 3080 SP  
3080 RL / 3085 Control Battery  
(93908-637, P093908637) (Requires  
2/unit)

12 Volt / 2.8 Ah 5933 \$32.00

Surgical Table 4085 12 Volt / 28.0Ah 12 Volt / 28.0 Ah NPX-100RFR \$128.00

**STILLE IMAGING**

Surgical Table 24 Volt / 10.0 Ah 6421 \$195.00

**STIMTECH (CODMAN)**

500 Chart Recorder 12 Volt / 7.0 Ah 5390 \$25.00  
78-7425, 81-2300 Stimpulse (Send in for Retrofit) 3.6 Volt / .225 Ah 5196 \$27.00  
ICP Express 12 Volt / 1.3 Ah 5547 \$27.00

**STRYKER INSTRUMENTS**

2115, 2115A, 2115B 9.6 Volt / 1.25 Ah 5693-A \$295.00  
(STR-2000) (Complete) 30 Day Warranty  
2115 (STR-2000) (Send in for Retrofit) 30 Day Warranty 9.6 Volt / 1.25 Ah 5693 \$95.00  
4112 (STR-4000) (Complete) 30 Day Warranty 9.6 Volt / .65 Ah 5758-A \$295.00  
4112 (STR-4000) (Send in for Retrofit) 30 Day Warranty 9.6 Volt / .65 Ah 5758 \$75.00  
4115 (STR-5000) 9.6 Volt / 1.25 Ah 5982 \$295.00  
(Rebuilt, reprogrammed with case) 30 Day Warranty  
4212 (Send in for Retrofit) 30 Day Warranty 9.6 Volt / .65 Ah 5145 \$232.00  
4215 (Send in for Retrofit) 30 Day Warranty 9.6 Volt / 1.25 Ah 5146 \$195.00  
AHTO Irrigation Pump (250-070-602) 16.8 Volt / 1.6 Ah 6085 \$95.00  
Bed 2010 (Requires 3/unit) 6 Volt / 12.0 Ah 5614 \$27.00  
Bed 660Z, 2040, 3002 Zoom Bed SM3004, SM1025 (1040-30-0000) 12 Volt / 33.0 Ah 5395 \$85.00  
(2/unit)  
Consta-vac Suction Pump 216-2-64, 216-3-64 (Send in for Retrofit) 7.2 Volt / 1.8 Ah 5294 \$70.00  
(Send in for Retrofit/Exchange)  
Dual Channel Smartpump Tourniquet System (5920-010-091) 12 Volt / 2.7 Ah 6185 \$95.00  
Endoscope Lightsource (220-130-000) 3.6 Volt / 7.2 Ah 5774 \$22.00  
I-Switch Wireless Foot Pedal (277-300-100) 6 Volt / 8.3 Ah 6199 \$10.00  
Neptune Rover, Gold 12 Volt / 7.0 Ah 5390 \$25.00  
Power Pro XT, IT, TL Ambulance Cot (6500-001-036) Dewalt Power System 24 Volt / 2.4 Ah 6449 \$195.00  
Power Pro XT, IT, TL Ambulance Cot (6500-101-010) SMRT Power System (OEM) 24 Volt / 2.4 Ah 6450 \$495.00  
SP-1C, SP-2CX Smart Pump Tourniquet (0AXINST10, 0AXSTGX10) 12 Volt / 2.7 Ah 6185 \$95.00  
Steri-Shield Helmet Systems (400-300) (Send in for Retrofit) 6 Volt / 7.0 Ah 5740 A \$25.00  
Steri-Shield Helmet Systems (400-325) (Send in for Retrofit) 6 Volt / 3.4 Ah 5740 B \$25.00  
T4 Power Pack (400-650) 6 Volt / 4.0 Ah 5948 \$295.00  
(Send in for Retrofit)

**SUNRISE MEDICAL (DEVILBISS)**

BioMedics Blower Controller 350000 12 Volt / 7.0 Ah 5390 \$25.00

MEDICAL BATTERIES MFG/MODEL VOLTAGE/CAPACITY R&D PART LIST PRICE

**SUNRISE MEDICAL (DEVILBISS) ... continued from previous page**

CHLA Lift	12 Volt / 33.0 Ah	5395	\$85.00
Patient Lift EMD 1800	12 Volt / 3.4 Ah	5667	\$41.00
ProAir Controller (Requires 2/unit)	12 Volt / 7.0 Ah	5390	\$25.00
TransAid, Sling Bed Scale	6 Volt / 1.2 Ah	5369	\$10.00
Voyager, Guardian Lift	24 Volt / 2.3 Ah	6138	\$90.00

**SUNTECH**

247 Vital Signs Monitor	6 Volt / 4.5 Ah	5374	\$12.00
-------------------------	-----------------	------	---------

**SUPERIOR HEALTH CARE GROUP**

Enteral Feeding Pump 83004	12 Volt / 1.3 Ah	5383	\$18.50
----------------------------	------------------	------	---------

**SURGITEK (ENDOTEK)**

Endodontic Condenser	2.4 Volt / .70 Ah	5182	\$18.00
Endotek 52940, 52966 Monitor	24 Volt / 1.8 Ah	5272	\$130.00
Pulse Oximeter	6 Volt / 1.8 Ah	5296	\$27.00
Surgitek OM-2, OM-3 Digital Urodata Monitor	24 Volt / 1.8 Ah	5272	\$130.00

**SYLVAN (FIBER OPTIC)**

Pediascan Transilluminator 100, 200, 500, 5000, Fiberoptic Infinity IT101, ILS101, 180	7.2 Volt / 1.8 Ah	5641	\$30.00
--	-------------------	------	---------

**TERUMO**

TE-311 Infusion Pump	9.6 Volt / .70 Ah	6354	\$20.00
----------------------	-------------------	------	---------

**T.H.E. MEDICAL**

Medical Lift (Requires 4/unit)	6 Volt / 10.0 Ah	5380	\$18.00
Stratus Portable Ceiling Lift (Requires 2/unit)	12 Volt / 2.5 Ah	5515	\$20.00
Titan X Bariatric Lift (Requires 2/unit)	12 Volt / 12.0 Ah	5551	\$45.00
Ultralift 3500XH Mobile Swing Lift (Requires 2/unit)	12 Volt / 7.0 Ah	5390	\$25.00
Ultralift 3500XH Mobile Swing Lift (Requires 2/unit)	12 Volt / 2.9 Ah	5969	\$38.00

**THORATEC**

Centrimag Backup Console (102598, 201-3009) Insert	31.5 V Alakline	6383-I	\$70.00
Centrimag Blood Pump (91-0000-04-3 REV.001)	20.4 Volt / 4.5 Ah	6309	\$245.00
Heartmate Power Base	12 Volt / 2.3 Ah	5389	\$40.00

**3M HEALTHCARE (CENTRIMED, RACAL & SARNES, AVI)**

Actrac 100	3.9 Volt / 2.0 Ah	5806	\$57.00
Air-Mate 1, 3 HEPA 10, 12 (007-00-15) (Insert)	3.6 Volt / 5.0 Ah	5826-I	\$35.00
Air-Mate 1, 3 HEPA 10, 12 (007-00-15) (Send in for Retrofit)	3.6 Volt / 5.0 Ah	5826	\$45.00
Air-Mate Breathe Easy BP15 (OEM)	4.8 Volt / 7.0 Ah	5919	\$445.00
Blood Pump 5000 System I	12 Volt / 12.0 Ah	5551	\$45.00
Blood Pump 9490	12 Volt / 7.2 Ah	5780	\$34.00
Blood Pump (Requires 4/unit)	6 Volt / 12.0 Ah	5377	\$22.00
Breathe Easy (9520-04-57ROI)Non-Rechargeable-(OEM)	12 Hour Use Grid - OEM	6454	\$625.00
Bubble Detector Monitor (13983)	8 Volt / 2.7 Ah	5275	\$54.00
Cadd-TPN Pump 5700 (21-2365)	12 Volt / 1.2 Ah	5558	\$70.00
CDI 100 Heart Lung	6 Volt / 7.0 Ah	5375	\$18.00
CDI 300, Sims 3000	12 Volt / 7.2 Ah	5780	\$34.00

**3M HEALTHCARE (CENTRIMED, RACAL & SARNES, AVI) ... continued from previous page**

Centrifuge Pump 7800, Heart Lung Machine 7000	12 Volt / 12.0 Ah	5820L	\$37.00
Delphen 7000	12 Volt / 7.0 Ah	5390	\$25.00
Delphen Pump Controller (Requires 2/unit)	12 Volt / 6.5 Ah	6022	\$65.00
External Pump 200	7.2 Volt / 1.6 Ah	6035	\$30.00
Heart Lung Machine 8000	12 Volt / 12.0 Ah	5551	\$45.00
Heart Lung Machine 9000, System 1	12 Volt / 28.0 Ah	5983	\$85.00
Infusion Pump 3000	12 Volt / 1.3 Ah	5547	\$27.00
Surgical Clipper 9602	2.4 Volt / .70 Ah	5001	\$6.95
Surgical Clipper 9671 (93157)	1.2 Volt / 1.6 Ah	6184	\$5.00
Surgical Shaver, Clipper 9661	1.2 Volt / 1.8 Ah	5853	\$4.90
 TPN Pump 5700 (21-3802)	12 Volt / 2.1 Ah	5558-NiMh	\$70.00

**TIOTU**

FD390 Doppler	9.6 Volt / .70 Ah	6075	\$60.00
FD400 Fetus Detector Doppler (Send in for Retrofit)	12 Volt / .70 Ah	6394	\$30.00

**TRANSMOTION MEDICAL**

TMM3A Video Fluroscopy Chair (Requires 4/unit)	6 Volt / 1.3 Ah	5469	\$14.00
TMM3B Video Fluroscopy Chair (Requires 2/unit)	12 Volt / 1.3 Ah	5383	\$18.50
TMM4/5A Transport / Surgical Stretcher (Requires 4/unit)	6 Volt / 1.3 Ah	5469	\$14.00
TMM4/5B Transport / Surgical Stretcher (Requires 2/unit)	12 Volt / 1.3 Ah	5383	\$18.50
TMM-XTB (Requires 2/unit)	12 Volt / 5.0 Ah	5388	\$25.00

**TRUMPF**

Jupiter OR Table	12 Volt / 10.0 Ah	6018	\$88.00
------------------	-------------------	------	---------

**TYCO HEALTHCARE (KENDALL)**

9525 SCD Express Compression System Controller (F010482, 1050060)	16.4 Volt / 2.0 Ah	6195	\$118.00
9525 SCD Express Compression System Controller (F010482, 1050060) OEM	16.4 Volt / 2.0 Ah	6195 B	\$175.00

**US IMAGING**

56-435 (Requires 2/unit)	12 Volt / 28.0 Ah	5850-B	\$110.00
C-Arm Table (Requires 2/unit)	12 Volt / 2.9 Ah	5969	\$38.00
Imaging Table 9650 (Requires 2/unit)	12 Volt / 1.3 Ah	5383	\$18.50

**U.S. SURGICAL**

Navigator Gamma Guidance System (ECF-2800C-L33L)	10.8 Volt / 3.0 Ah	6013	\$95.00
Navigator Gamma Guidance System (GG-0400-24)	10.8 Volt / 3.0 Ah	5990	\$95.00
Navigator GPS Power Pak (097113)	12 Volt / 2.0 Ah	5771	\$42.00





**WELCH ALLYN (GRASON-STADLER, PROTOCOL) ... continued from previous page**

	<p>71000-A, 71020-A, 71000C, 71020-C, 71055-C, 72300 Audioscope 3 Audiometer</p>	<p>3.6 Volt / .75 Ah</p>	<p>5224</p>	<p>\$12.00</p>
<p>71960 Used in 71900 Smart Handle (OEM)</p>		<p>3.5 Volt / 2.5 Ah</p>	<p>6416</p>	<p>\$195.00</p>
<p>72100, 72110, 617, 717</p>		<p>2.4 Volt / .750 Ah</p>	<p>5135</p>	<p>\$17.50</p>
<p>72240, 12000 Binocular Ophthalmoscope</p>		<p>4.8 Volt / 1.8 Ah</p>	<p>6044</p>	<p>\$45.00</p>
<p>72250, Lumi Veiw Ophthalmoscope</p>		<p>3.6 Volt / 1.8 Ah</p>	<p>6045</p>	<p>\$30.00</p>
<p>72420 (0017003) (OEM)</p>		<p>7.2 Volt / 1.35 Ah</p>	<p>6130</p>	<p>\$295.00</p>
<p>72500, 76100</p>		<p>3.6 Volt / .11 Ah</p>	<p>5682</p>	<p>\$12.00</p>
<p>72600, 72800, 72801, 72830</p>		<p>2.4 Volt / .70 Ah</p>	<p>5182</p>	<p>\$18.00</p>
<p>72610 Compact Otoscope 93400</p>		<p>2.4 Volt / .60 Ah</p>	<p>6046</p>	<p>\$18.00</p>
<p>72900, MicroTympl II</p>		<p>2.4 Volt / .60 Ah</p>	<p>5831</p>	<p>\$15.00</p>
	<p>AED 10 Jump Start (001852)</p>	<p>12 Volt / 2.8 Ah</p>	<p>6067</p>	<p>\$60.00</p>
<p>AED 20 (Non-Rechargeable) (00183-0E) (Send in for Retrofit)</p>		<p>12 Volt / 5.2 Ah</p>	<p>6001</p>	<p>\$90.00</p>
<p>AED 20 Rechargeable (001829-E) (Send in for Retrofit)</p>		<p>12 Volt / 2.1 Ah</p>	<p>6107-R</p>	<p>\$165.00</p>
<p>Argus VCM Monitor</p>		<p>6 Volt / 4.5 Ah</p>	<p>5374</p>	<p>\$12.00</p>
	<p>Atlas Monitor, 210 EKG, VSM 6200, 62000 (6200-41) (511-0017-00)</p>	<p>6 Volt / 7.2 Ah</p>	<p>5053</p>	<p>\$30.00</p>
<p>Audio Path, GSI 70 (1770-9672)</p>		<p>7.2 Volt / 1.0 Ah</p>	<p>5046</p>	<p>\$29.00</p>
<p>Connex Pro BP3400 (BATT11, 719028-2) (OEM)</p>		<p>3.7 Volt / 2.1 Ah</p>	<p>6414</p>	<p>\$80.00</p>
<p>Connex VSM 6000 (BATT69) 6 cell (OEM)</p>		<p>10.8 Volt / 4.5 Ah</p>	<p>6408-B</p>	<p>\$196.00</p>
<p>Connex VSM 6000 (BATT99) 9 cell (OEM)</p>		<p>10.8 Volt / 6.75 Ah</p>	<p>6408</p>	<p>\$279.00</p>
<p>CP100, CP200</p>		<p>6 Volt / 4.5 Ah</p>	<p>6437</p>	<p>\$18.00</p>
<p>CP100, CP200 Li-Ion upgrade (105204) OEM</p>		<p>6.4 Volt / 6.0 Ah</p>	<p>6456</p>	<p>\$221.00</p>
<p>CP10, CP10i, CP20, ECG (53013-0000)</p>		<p>12 Volt / 2.5 Ah</p>	<p>5515</p>	<p>\$20.00</p>
<p>Elite Stethoscope (5079-425)</p>		<p>3 Volt / 1.5 Ah</p>	<p>5517</p>	<p>\$5.25</p>
<p>GSI 37 Tympanometer, 71130</p>		<p>7.2 Volt / .225 Ah</p>	<p>5911</p>	<p>\$25.00</p>

**WELCH ALLYN (GRASON-STADLER, PROTOCOL) ... continued from previous page**



Lifesign Analyzer 4200, 5000, 52000  
BP/SPO2, Quick Sign, ECG, EL  
(5200-84)

6 Volt / 4.5 Ah 5077 \$15.00

Manuel Audiometer 5200 AM232, GSI 17, 72320 7.2 Volt / 1.8 Ah 5917 \$35.00

Pic 30, 40, 50 Superpac (001647-U) 12 Volt / 4.0 Ah 5955 \$195.00

Pic 30, 40, 50 Superpac (001647-U) (Send in for Retrofit) 12 Volt / 4.0 Ah 5955-R \$90.00

Pneumo Check, Spirometer 6100 (Requires 2/unit) 3.6 Volt / .11 Ah 5682 \$12.00

Propaq LT (008-0857-00, 010-0230-02) (OEM) 8.4 Volt / 1.9 Ah 6379 \$195.00

SP10 12 Volt / 0.8 Ah 5895 \$22.00

Spot 420, VSM 300 Series, 42NOB, 53NTB, 53NTL, 63NTB  
(501-0015-01) (4200-84) 6 Volt / 4.5 Ah 6039 \$14.00

Spot Vital Signs LXI Monitor, 45NTL, 45NTO (400732, 4500-84) 6 Volt / 6.0 Ah 6131-P \$30.00



Spot Vital Signs Monitor 42MTO  
Series (105631) - Li-Ion Upgrade Kit  
(OEM)

6.4 Volt / 6.0 Ah 6434 \$255.00

Spot Vital Signs Monitor 42MTO Series (Fits LXI Unit)(105632) -  
Li-Ion Upgrade Kit (OEM) 6.4 Volt / 6.0 Ah 6441 \$255.00



VSM 53NOP, 53NTO, 53NTP,  
53OTO, 5350P, 53000, 4200, 5200,  
506DNV  
(Fuse Inline)

6 Volt / 4.5 Ah 6065 \$14.00

VSM 6200 6 Volt / 7.2 Ah 5053 \$30.00

Welch Allyn Pro 4000 Rechargeable (53020-0000) 2.4 Volt / .73 Ah 6431 \$18.00

**WESCOM**

NC3000 Nurse Call 3.6 Volt / 1.2 Ah 5466 \$9.00

**WR MEDICAL (HILGER)**

BP102 (Disposable Pack) 15 Volt / 20.0 Ah 5583 \$40.00

Hilger Facial Nerve Stimulator HR2, 2R 8.4 Volt / 2.3 Ah 5038 \$37.00

Silverstein S8 Facial Stimulator (Requires 2/unit) 8.4 Volt / 2.3 Ah 5038 \$37.00

**MEDICAL BATTERIES MFG/MODEL**

**VOLTAGE/CAPACITY**

**R&D PART**

**LIST PRICE**

**ZEVEX**

Enteratlite Pump (Z-11645 Rev. E)	7.2 Volt / 1.6 Ah	5965	\$40.00
-----------------------------------	-------------------	------	---------

**ZOLL (ZMI)**



AED Plus (10 Battery Set)  
(8000-0807-01)

30 Volt / 1.3 Ah      6003      \$60.00

AED Pro (Non-Rechargeable) (8000-0860-01, 1008-1003-01) (OEM)      12 Volt / 4.3 Ah      6194      \$160.00

Autopulse (8700-0702-01) (OEM)      32.4 Volt / 3.2 Ah      6347      \$850.00

M-Series (Memory)      3 Volt / .19 Ah      CR1632      \$3.25

Pacemaker Monitor NTP-1000 (Insert)      12 Volt / 4.3 Ah      5136      \$95.00



PD1400, 1600, 1700, 2000, 4410,  
M Series

10 Volt / 2.5 Ah      5603      \$62.00

PD1400, 1600, 1700, 2000, 4410, M Series, AED Pro (8000-0299-01) (OEM)      10 Volt / 2.5 Ah      6103      \$140.00

Pic 30, 40, 50 Superpac (001647-U)      12 Volt / 4.0 Ah      5955      \$195.00

Pic 30, 40, 50 Superpac (001647-U) (Send in for Retrofit)      12 Volt / 4.0 Ah      5955-R      \$90.00

R Series, E Series Defibrillator Sure Power (8019-0535-01) (OEM)      10.8 Volt / 5.8 Ah      6198      \$475.00

Smart Ready Battery Complete (8004-0104-01) (OEM)      10 Volt / 2.5 Ah      6115      \$160.00



XL Smart Ready Battery  
(8000-0500-01) (OEM)

10 Volt / 4.5 Ah      6111      \$265.00

XL Smart Ready Battery (8000-0686-01) (OEM) (3 Pack)      10 Volt / 4.5 Ah      6111-3      \$635.00

X-Series, Propaq MD, Sure Power II, (8000-0580-01)      11.1 Volt / 6.6 Ah      6448      \$595.00

Zoll Pacemaker Monitor/ Defibrillator PD900, PD1200 (8000-0052)      12 Volt / 2.5 Ah      5279      \$68.00

**ZONARE MEDICAL SYSTEMS**

Z. One Smartcart, Z-Pak (85031-00) (Send in for Retrofit)	15.6 Volt / 16.0 Ah	6215	\$575.00
---	---------------------	------	----------

**ZYNO**

Z800 Infusion Pump (BS10-000558, BS10-000778)	9.6 Volt / 4.5 Ah	6385	\$85.00
---	-------------------	------	---------

<b>ALPHA TECHNOLOGIES</b>			
AS1000, UPS1000, UPS1500, UPS2000, UPS2200	12 Volt / 18.0 Ah	3391	\$195.00
AS1500, CFR1500, AS2000, CFR2500, FR3000	12 Volt / 18.0 Ah	4391	\$260.00
BP3100-36 (Requires 3/unit)	12 Volt / 28.0 Ah	5983	\$85.00
CFR1500RM, CFR5000	12 Volt / 33.0 Ah	4395	\$340.00
UPS600	12 Volt / 18.0 Ah	2391	\$130.00

<b>AMERICAN POWER CONVERSION - APC</b>			
<b>APC BACK-UPS</b>			
BE325, BE325CN (ES Series)	12 Volt / 5.4 Ah	1984	\$36.00
BE350, BE500 (ES Series)	12 Volt / 5.5 Ah	1388	\$33.00
BE350C, BE350G, BE350U, BE350R, BE3500T, (ES Series)	12 Volt / 3.4 Ah	1384	\$25.00
BE500C, BE500R, BE500U (ES Series)	12 Volt / 8.5 Ah	1390	\$33.00
BE550G, 550R, BE650BB, BE650BB-CN, BE650G, BE700BB, BE725BB, BE750G (ES Series)	12 Volt / 9.0 Ah	1986	\$34.00
BE750BB (ES Series)	12 Volt / 12.0 Ah	1551	\$45.00
BF250, BF280, BFG280C, BF350, BF350U, BF400C, BF500, BF500BB, BF500U	12 Volt / 5.4 Ah	1984	\$36.00
BH500NET	12 Volt / 8.5 Ah	1390	\$33.00
BK200, BK200B	12 Volt / 4.5 Ah	2374-A	\$28.00
BK250B, BK280B, BK300C, BK300X116, BK400, BK400B, BK500MC, BK200, BK200B, PCPER	12 Volt / 8.5 Ah	1390	\$33.00
BK350, BK350X290, BK500, BK500BLK	12 Volt / 8.5 Ah	1390	\$33.00
BK450, BK600, BK600C, BK650M, PCNET	12 Volt / 12.0 Ah	2614-A	\$40.00
BK650MC, BK650X06	12 Volt / 12.0 Ah	1551	\$45.00
BP1000, BP1100 (Pro Series)	24 Volt / 12.0 Ah	2551-A	\$90.00
BP1400, BP1400X116 (Pro Series)	24 Volt / 18.0 Ah	2391-A	\$130.00
BP280, BP280C, BP280IPNP, BP280PNP, BP280S, BP280SX116, BP350U, BP350UC, BP420, BP420C, BP420IPNP, BP420PNP, BP420S, BP500U, SP500DR (Pro Series)	12 Volt / 8.5 Ah	1390	\$33.00
BP500UC, BP500CLR, BP700UC	12 Volt / 8.5 Ah	1390	\$33.00
BP650PNP, BP650S, BP650IPNP, BP650SC, BP650SX107 (Pro Series)	12 Volt / 12.0 Ah	1551	\$45.00
BR1300LCD, BR1500	12 Volt / 9.0 Ah	2986	\$68.00
BR1500LCD	24 Volt / 8.5 Ah	2390-A	\$66.00
BR500, BR700G	12 Volt / 8.5 Ah	1390	\$33.00
BR800BLK, BR900, BR1000, BR1200	12 Volt / 8.5 Ah	2390	\$66.00
BX800, BX900R, BX1000, BX1300G, BX1500LCD	12 Volt / 8.5 Ah	2390	\$66.00
MX3000, MX3000XR, MX5000, MX5000XR (MATRIX)	12 Volt / 75.0 Ah	4901	\$700.00
<b>APC PART NUMBER CROSS REFERENCE</b>			
RBC1	12 Volt / 4.5 Ah	2374-A	\$28.00
RBC105	12 Volt / 9.0 Ah	8986	\$272.00
RBC109	12 Volt / 9.0 Ah	2986	\$68.00
RBC10, RBC21	12 Volt / 5.4 Ah	1984	\$36.00
RBC11	48 Volt / 18.0 Ah	4391-A	\$260.00
RBC110, RBC114	12 Volt / 9.0 Ah	1986	\$34.00
RBC12	96 Volt / 8.5 Ah	8390-A	\$265.00
RBC13, RBC14	12 Volt / 75.0 Ah	4901	\$700.00
RBC17	12 Volt / 9.0 Ah	1986	\$34.00
RBC18	6 Volt / 7.0 Ah	2375	\$28.00
RBC20	12 Volt / 5.5 Ah	2388	\$66.00
RBC22, RBC32, RBC33	12 Volt / 8.5 Ah	2390	\$66.00
RBC23, RBC25, RBC57, RBC59	12 Volt / 8.5 Ah	4390	\$132.00
RBC24	12 Volt / 9.0 Ah	4986	\$136.00

UPS

**AMERICAN POWER CONVERSION - APC ... continued from previous page****APC PART NUMBER CROSS REFERENCE ... continued from previous page**

RBC26, RBC27	12 Volt / 8.5 Ah	8390	\$265.00
RBC29	12 Volt / 5.5 Ah	1388	\$33.00
RBC2, RBC40	12 Volt / 8.5 Ah	1390	\$33.00
RBC3	12 Volt / 12.0 Ah	2614-A	\$40.00
RBC31	6 Volt / 4.5 Ah	8374	\$112.00
RBC34	6 Volt / 7.0 Ah	4375	\$56.00
RBC35	12 Volt / 3.4 Ah	1384	\$25.00
RBC36	12 Volt / 9.0 Ah	3986	\$102.00
RBC39	12 Volt / 18.0 Ah	1391	\$65.00
RBC4	12 Volt / 12.0 Ah	1551	\$45.00
RBC43	12 Volt / 5.5 Ah	8388	\$264.00
RBC44	12 Volt / 5.5 Ah	16388	\$528.00
RBC45, RBC46	12 Volt / 5.5 Ah	1388	\$33.00
RBC47	12 Volt / 3.4 Ah	1384	\$25.00
RBC55	48 Volt / 18.0 Ah	4391-A	\$260.00
RBC5, RBC9, RBC48, RBC53, RBC54, RBC60, RBC62	24 Volt / 8.5 Ah	2390-A	\$66.00
RBC63	12 Volt / 9.0 Ah	4986	\$136.00
RBC6, RBC51, RBC52	24 Volt / 12.0 Ah	2551-A	\$90.00
RBC7 (Complete with fuse & connector)	24 Volt / 18.0 Ah	2391-AP	\$175.00
RBC7 (Insert Only) RBC49, RBC50	24 Volt / 18.0 Ah	2391-A	\$130.00
RBC8	48 Volt / 8.5 Ah	4390-A	\$132.00
SYBT2	12 Volt / 5.0 Ah	10388	\$330.00

**APC SMART-UPS**

PS250, PS450	6 Volt / 7.0 Ah	2375	\$28.00
SC1000 (SC Series)	12 Volt / 8.5 Ah	2390	\$66.00
SC1500 (SC Series)	12 Volt / 8.5 Ah	4390	\$132.00
SC250RM1U, SC450RM1U (SC Series)	6 Volt / 7.0 Ah	2375	\$28.00
SC420 (SC Series)	12 Volt / 8.5 Ah	1390	\$33.00
SC620 (SC Series)	12 Volt / 12.0 Ah	1551	\$45.00
SU1000RM2U, SU1000R2BX120	12 Volt / 8.5 Ah	4390	\$132.00
SU1000, SU1000RM, SU1000NET, SU1000BX120, SU1000RMNET, SU1000X127, SU1000X93	24 Volt / 12.0 Ah	2551-A	\$90.00
SU1000XL, SU1000X93, SU1400, SU1400BX120, SU1400NET, SU1400X93, SU1400X145, SU1400X106	24 Volt / 18.0 Ah	2391-A	\$130.00
SU1400R2BX120, SU1400RM2UX93, SU1400RM2U, SU1400R2X122	12 Volt / 9.0 Ah	4986	\$136.00
SU1400RM, SU1400RMBX120, SU1400RMNET, SU1400RMX106, SU1400RMX93, SU1400RMX176	48 Volt / 8.5 Ah	4390-A	\$132.00
SU1400RMXL3U, SU1400RMXLB3U (XL Series)	12 Volt / 8.5 Ah	4390	\$132.00
SU1400RMXLNET, SU1400RMXLNET, SU1400XLNET (XL Series)	48 Volt / 18.0 Ah	4391-A	\$260.00
SU1500RMX155, SU2000R3X155	24 Volt / 12.0 Ah	2551-A	\$90.00
SU2200RM3U, SU2200R3BX120, SU2200R3X106, SU2200R3X147, SU2200R3X152, SU2200R3X167, SU2200RMUS	96 Volt / 8.5 Ah	8390-A	\$265.00
SU2200RMXL, SU2200RMXLNET, SU2200RMXLNET, SU2200XLNET, SU2200RMXL3U, SU2200XLTX153, SU2200XLNET, SU2200RMXLTX153, SUA2200XL, SUA2200XL-NETPKG (XL Series)	48 Volt / 18.0 Ah	4391-A	\$260.00
SU2200, SU2200BX120, SU2200NET, SU2200RM, SU2200RMNET, SU2200XL, SU2200X106, SU2200X111, SU2200X115, SU2200X93	48 Volt / 18.0 Ah	4391-A	\$260.00

<b>AMERICAN POWER CONVERSION - APC ... continued from previous page</b>			
<b>APC SMART-UPS ... continued from previous page</b>			
SU3000R3BX120, SU3000R3X145, SU3000RMT3U, SU3000RM3U, SU3000RMUS, SU3000RMTX136	96 Volt / 8.5 Ah	8390-A	\$265.00
SU3000RMXL3U (XL Series)	12 Volt / 8.5 Ah	8390	\$265.00
SU3000, SU3000NET, SU3000RMNET, SU3000RMX93, SU3000RM, SU3000X177, SU5000RMT5U	48 Volt / 18.0 Ah	4391-A	\$260.00
SU450, SU450NET, SU700, SU700BX120, SU700NET, SU700RM, SU700RMNET, SU700X93,	24 Volt / 8.5 Ah	2390-A	\$66.00
SU5000R5XLT-TF3, SU5000R5XLTXFMR, SU5000RMXL5U (XL Series)	96 Volt / 8.5 Ah	8390-A	\$265.00
SU5000T, SU5000RMT5UXFMR, SU5000R5TBX120, SU5000TXFMR, SU5000R5TBXFMR, SU5000R5T-TF3	96 Volt / 8.5 Ah	8390-A	\$265.00
SU700RM2U, SU700R2BX120	12 Volt / 8.5 Ah	2390	\$66.00
SU700X167	24 Volt / 12.0 Ah	2551-A	\$90.00
SU700XL	24 Volt / 18.0 Ah	2391-A	\$130.00
SU700XLNET, SUA750XL, SU1000XLNET, SUA1000XL (XL Series)	24 Volt / 18.0 Ah	2391-A	\$130.00
SUA1000RM1U	6 Volt / 7.0 Ah	4375	\$56.00
SUA1000RM2U	12 Volt / 8.5 Ah	4390	\$132.00
SUA1500R2X122, SUA1500R2X180, SUA1500RM2U, SUA1500R2X93	12 Volt / 9.0 Ah	4986	\$136.00
SUA1500, SUA1500X448, SUA1500X93, SUA1500X413	24 Volt / 18.0 Ah	2391-A	\$130.00
SUA2200R2X147, SUA2200RM2U, SUA2200R2X106, SUA3000RM2U, SUA3000R2X145, SUA3000RMT2U, SUA3000R2X180	12 Volt / 5.5 Ah	8388	\$264.00
SUA2200RMXL3U, SUA2200R3XLNETPKG, SUA3000R3XLNETPKG, SUA3000RMXL3U (XL Series)	12 Volt / 9.0 Ah	8986	\$272.00
SUA2200, SUA3000, SUA5000R5TXFMR, SUA5000RMT5U	48 Volt / 18.0 Ah	4391-A	\$260.00
SUA3000XL, SUA3000XL-NETPKG, SUA3000XLT (XL Series)	48 Volt / 18.0 Ah	4391-A	\$260.00
SUA750RM1U	6 Volt / 7.0 Ah	4375	\$56.00
SUA750RM2U, SUA750R2X338	12 Volt / 8.5 Ah	2390	\$66.00
SUA750, SUA1000	24 Volt / 8.5 Ah	2390-A	\$66.00
SUM1500RMXL2U, SUM3000RMXL2U (XL Series)	12 Volt / 5.5 Ah	8388	\$264.00
SUVS1000	24 Volt / 12.0 Ah	2551-A	\$90.00
SUVS1400	24 Volt / 18.0 Ah	2391-A	\$130.00
SUVS420	12 Volt / 8.5 Ah	1390	\$33.00
SUVS650	12 Volt / 12.0 Ah	1551	\$45.00
<b>APC SMART-UPS RT</b>			
SURT10000XLT, SURT10000RMXL6U, SURT10000RMXLT, SURT10000RMXLT-2TF5, SURT10KRMXL6U-TF5, SURT10000XLT-1TF10K, SURT10000XLT-2TF3	12 Volt / 5.5 Ah	16388	\$528.00
SURT6000XLT, SURT6000RMXL3U, SURT6000RMXLT, SURT6000RMXLT-1TF5, SURT6KRMXL3U-TF5, SURT6000XLT-1TF3, SURTD6000RMXLP3U	12 Volt / 5.5 Ah	16388	\$528.00
SURT7500XLT, SURT7500RMXLT, SURT7500RMXLT-1TF5, SURT7500XLT-1TF3	12 Volt / 5.5 Ah	16388	\$528.00
SURT8000XLT, SURT8000RMXL6U, SURT8000RMXLT, SURT8000RMXLT-1TF5, SURT8KRMXL6U-TF5, SURT8000XLT-1TF3	12 Volt / 5.5 Ah	16388	\$528.00
SURTA1500XL, SURTA1500RMXL2U, SURTA1500RMXL, SURTA2000XL, SURTA2000RMXL2U, SURTA2000RMXL	12 Volt / 8.5 Ah	4390	\$132.00

UPS

**AMERICAN POWER CONVERSION - APC ... continued from previous page**

**APC SMART-UPS RT ... continued from previous page**

SURTA3000XL, SURTA3000RMXL3U, SURTA3000RMXL3U, SURTD3000XLT, SURT3000XLT, SURTD3000RMXL3U, SURTD3000RMXLT, SURT3000RMXLT, SURTD3KRMXL3U-TF5, SURT3000RMXLT-1TF5, SURTD3000XLT-1TF3, SURT3000XLT-1TF3	12 Volt / 5.5 Ah	16388	\$528.00
SURTD5000XLT, SURT5000XLT, SURTD5000RMXL3U, SURTD5000RMXLT, SURT5000RMXLT, SURT5000RMXLT-1TF5, SURTD5000RMXLT-1TF5, SURTD5000RMXLP3U, SURTD5000XLT-1TF3, SURT5000XLT-1TF3	12 Volt / 5.5 Ah	16388	\$528.00

**BELKIN**

F6C100	24 Volt / 12.0 Ah	2551-A	\$90.00
F6C100-4	24 Volt / 18.0 Ah	2391-A	\$130.00
F6C1500-TW-RK, F6C110-RKM-2U	12 Volt / 8.5 Ah	2390	\$66.00
F6C150-RKM-2U	12 Volt / 5.5 Ah	4388	\$132.00
F6C230-RKM-2U	12 Volt / 9.0 Ah	4986	\$136.00
F6C320-RKM-3U	12 Volt / 12.0 Ah	4551	\$180.00
F6C325-SER, F6C350-USB, F6C425-SER, F6C500-USB, F6C500-USB-MAC, F6C525-SER, F6C625-SER, F6C650-USB, F6C127-BAT-ATT, F6H650-USB, F6H650-SER, F6C425, F6C525, F6C625	12 Volt / 8.5 Ah	1390	\$33.00
F6C350-SER-SB, F6C500-SER-SB, F6C650-SER-SB	12 Volt / 5.4 Ah	1984	\$36.00
F6C550-AVR, F6C750-AVR, F6H375-USB, F6H550-USB, F6H350-SER, F6H350-USB, F6H500-SER, F6H500-USN	12 Volt / 5.5 Ah	1388	\$33.00
F6C550-AVR Rev. A	12 Volt / 9.0 Ah	1986	\$34.00
F6C700, F6C100-UNV, F6C120-UNV, F6C500-UNV, F6C800-UNV	24 Volt / 8.5 Ah	2390-A	\$66.00
F6C900-UNV, F6C1000-TW-RK, F6C1100-UNV, F6C1200-UNV, F6C1250-TW-RK	12 Volt / 5.5 Ah	2388	\$66.00

**CLARY**

S1000	12 Volt / 8.5 Ah	4390	\$132.00
S1250, S1500	12 Volt / 8.5 Ah	6390	\$198.00
S1500-601	12 Volt / 5.5 Ah	6388	\$198.00
S2000	12 Volt / 5.5 Ah	8388	\$264.00

**CONTEXT**

CNB300	12 Volt / 5.5 Ah	1388	\$33.00
CNB325	12 Volt / 3.4 Ah	1384	\$25.00
CNB700, CNB900, 700AVR, 900AVR	12 Volt / 12.0 Ah	1551	\$45.00
CNB750	12 Volt / 8.5 Ah	2390	\$66.00
CNB950	12 Volt / 9.0 Ah	1986	\$34.00

**CYBER POWER SYSTEMS**

ABP36VRM2U, OL2000RMXL2U	12 Volt / 8.5 Ah	6390	\$198.00
ABP72VRM2U	12 Volt / 9.0 Ah	12986	\$408.00
BH1500, CP1500AVRT	12 Volt / 9.0 Ah	2986	\$68.00
BP48V45ART2U, PR3000SWRM2U	12 Volt / 8.5 Ah	8390	\$265.00
BP48V75ART2U	12 Volt / 9.0 Ah	8986	\$272.00
CP1285AVRLCD, CP1350AVRLCD, CP1500AVRLCD	12 Volt / 8.5 Ah	2390	\$66.00
CP585LCD, CP600LCD, CP685AVRLCD, CP685AVR	12 Volt / 8.5 Ah	1390	\$33.00



**CYBER POWER SYSTEMS ... continued from previous page**

CP800AVR, CPS825AVR, CP1000AVRLCD	12 Volt / 9.0 Ah	1986	\$34.00
CP825AVRLCD, CP825LCD, CP850AVRLCD	12 Volt / 8.5 Ah	1390	\$33.00
CP900AVR, CP1200AVR	12 Volt / 8.5 Ah	2390	\$66.00
CPS1500AVRHO, OP1250, CPS1250AVR	12 Volt / 9.0 Ah	2986	\$68.00
CPS1500AVR, OP1500	12 Volt / 8.5 Ah	4390	\$132.00
CPS300SL, CPS320SL, CPS325SL, CP425G	12 Volt / 3.4 Ah	1384	\$25.00
CPS375SL, CPS425SL, CP485SL, CP500HG, UP425	12 Volt / 5.5 Ah	1388	\$33.00
CPS500SL, CPS525SL, CP550SL, CPS575SL, CPS650SL, UP625	12 Volt / 8.5 Ah	1390	\$33.00
CPS585AVR, CPS625AVR, CPS700AVR, OP650	12 Volt / 8.5 Ah	1390	\$33.00
CPS725SL, UP825	12 Volt / 9.0 Ah	1986	\$34.00
CPS900AVR, CPS1000AVR, CPS1100AVR, OP850	12 Volt / 8.5 Ah	2390	\$66.00
OL1000RMXL2U	12 Volt / 8.5 Ah	3390	\$99.00
OL1500RMXL2U	12 Volt / 9.0 Ah	3986	\$102.00
OL3000RMXL2U	12 Volt / 9.0 Ah	6986	\$204.00
OR1000LCDRM1U, OR1500LCDRM1U	6 Volt / 7.0 Ah	4375	\$56.00
OR1500LCDRM2U	12 Volt / 8.5 Ah	4390	\$132.00
OR2200LCDRM2U	12 Volt / 9.0 Ah	4986	\$136.00
OR500LCDRM1U, OR700LCDRM1U	6 Volt / 7.0 Ah	2375	\$28.00
PP1100SW, PP1500SWT2	12 Volt / 12.0 Ah	2551	\$90.00
PP2200SW, PR1000LCDRTXL2Ua	12 Volt / 9.0 Ah	4986	\$136.00
PP800SW	12 Volt / 8.5 Ah	2390	\$66.00
PR1000LCDRT2U, PR1000LCDRTXL2U, PP1500SWT4, PR1500SWRM2U, PR1500LCDRT2U	12 Volt / 8.5 Ah	4390	\$132.00
PR1500LCDRTXL2U, PR2200LCDRT2U, PR2200LCDRTXL2U, PR3000LCDRT2U, PR2200SWRM2U	12 Volt / 9.0 Ah	4986	\$136.00
PR750LCDRM1U, PR1000LCDRM1U	6 Volt / 7.0 Ah	4375	\$56.00
UP1200	12 Volt / 8.5 Ah	2390	\$66.00
UR500RM1U, UR700RM1U	6 Volt / 7.0 Ah	2375	\$28.00

**DATA GENERAL**

400	12 Volt / 18.0 Ah	4391	\$260.00
C4-775A, L600	12 Volt / 8.5 Ah	2390	\$66.00

**DATASHIELD**

AT1200-01	12 Volt / 18.0 Ah	4391	\$260.00
AT1200-02, AT1500	12 Volt / 24.0 Ah	4393	\$280.00
AT500-02, AT800-02	12 Volt / 24.0 Ah	2393	\$140.00
AT5000, AT500-01	12 Volt / 12.0 Ah	2551	\$90.00
AT800-01	12 Volt / 18.0 Ah	2391	\$130.00
PC200, PC200A, ST450-01, ST550-01	6 Volt / 13.5 Ah	2614	\$40.00
ST360	12 Volt / 8.5 Ah	1390	\$33.00
ST450-02, ST550-02, ST675, ST900	12 Volt / 18.0 Ah	1391	\$65.00

**DELL**

10KWMRS (Rack 10K) (Requires 24 per unit)	12 Volt / 9.0 Ah	1986	\$34.00
10WLSR (Rack 1000), 10WST (Tower 1000)	12 Volt / 9.0 Ah	3986	\$102.00
150WSR (Rack 1500), 192WST (Tower 1920)	12 Volt / 9.0 Ah	6986	\$204.00
23WSR (Rack 2300)	12 Volt / 9.0 Ah	8986	\$272.00
375WSR (Rack 3750), 42WMSR (Rack 4200)	12 Volt / 8.5 Ah	16390	\$530.00
56WMSR (Rack 5600) (Requires 18 per unit)	12 Volt / 8.5 Ah	1390	\$33.00
DL1400R2U, DL1400RM, DLA1500RMTSSU	12 Volt / 8.5 Ah	4390	\$132.00
DL2200RM3U, DL3000RM3U, DLA3000RMI3U	12 Volt / 8.5 Ah	8390	\$265.00
DL5000RMI5U, DL5000RMT5U	12 Volt / 8.5 Ah	16390	\$530.00

**DELL ... continued from previous page**

DL700, DL700I, DL700RMT5SU, DLA750, 500WST (Tower 500)	12 Volt / 8.5 Ah	2390	\$66.00
DLA1500, DLA2200, DLA3000	48 Volt / 18.0 Ah	4391-A	\$260.00
DLA1500RM2U, DLA1500RM2IU	12 Volt / 8.5 Ah	4390	\$132.00
DLA2200RM2U, DLA2200RMI2U	12 Volt / 5.5 Ah	8388	\$264.00
DLA3000RM2U, DLA3000RMI2U, DLA3000RMT2U	12 Volt / 5.5 Ah	8388	\$264.00

**DITEK**

DRP16	12 Volt / 5.4 Ah	1984	\$36.00
DTK-BU450, DTK-BU600PLUS	12 Volt / 5.5 Ah	1388	\$33.00

**DYNATECH**

SRF550-2	12 Volt / 18.0 Ah	2391	\$130.00
SRF560-2	24 Volt / 18.0 Ah	2391-A	\$130.00

**EATON (BEST POWER, DELTEC, EXIDE, POWERWARE)****BEST POWER - AXXIUM - RACKMOUNT**

0620-1000U	12 Volt / 9.0 Ah	3986	\$102.00
0620-1500U	12 Volt / 9.0 Ah	4986	\$136.00

**BEST POWER - BEST - 610**

B610-0700U	12 Volt / 8.5 Ah	2390	\$66.00
B610-1000U	12 Volt / 8.5 Ah	3390	\$99.00
B610-1500U	12 Volt / 8.5 Ah	4390	\$132.00
B610-2000U, B610-3000U	12 Volt / 8.5 Ah	8390	\$265.00

**BEST POWER - FERRUPS - FC**

FC15KVA	12 Volt / 75.0 Ah	14901	\$2,450.00
FC3KVA, FC5KVA	12 Volt / 75.0 Ah	4901	\$700.00
FC7.5KVA, FC10KVA	12 Volt / 75.0 Ah	10901	\$1,750.00

**BEST POWER - FERRUPS - FD**

FD10KVA	12 Volt / 33 Ah	10395	\$850.00
FD12.5KVA	12 Volt / 75.0 Ah	10901	\$1,750.00
FD18KVA	12 Volt / 75.0 Ah	10901	\$1,750.00
FD4.3KVA	12 Volt / 33.0 Ah	4395	\$340.00
FD5.3KVA	12 Volt / 75.0 Ah	4901	\$700.00
FD7KVA	12 Volt / 75.0 Ah	4901	\$700.00

**BEST POWER - FERRUPS - FE**

FE10KVA	12 Volt / 33 Ah	10395	\$850.00
FE12.5KVA	12 Volt / 75.0 Ah	10901	\$1,750.00
FE1.4KVA, FE1.15KVA	12 Volt / 75.0 Ah	1901	\$175.00
FE18KVA	12 Volt / 100 Ah	5987	\$215.00
FE1.8KVA, FE2.1KVA	12 Volt / 18.0 Ah	4391	\$260.00
FE3.1KVA, FE4.3KVA	12 Volt / 33.0 Ah	4395	\$340.00
FE500VA	12 Volt / 33.0 Ah	2395	\$170.00
FE5.3KVA, FE7KVA	12 Volt / 75.0 Ah	4901	\$700.00
FE700VA, FE850VA	12 Volt / 33.0 Ah	1395	\$85.00

**BEST POWER - FERRUPS - MD**

MD1.5KVA, MD2KVA	12 Volt / 33.0 Ah	4395	\$340.00
MD350VA, MD500VA	12 Volt / 33.0 Ah	1395	\$85.00
MD750VA, MD1KVA	12 Volt / 75.0 Ah	1901	\$175.00

**BEST POWER - FERRUPS - ME**

ME1.15KVA, ME1.4KVA	12 Volt / 75.0 Ah	1901	\$175.00
ME1.8KVA	12 Volt / 18.0 Ah	4391	\$260.00

**EATON (BEST POWER, DELTEC, EXIDE, POWERWARE) ... continued from previous page**

<b>BEST POWER - FERRUPS - ME ... continued from previous page</b>			
ME2.1KVA, ME3.1KVA	12 Volt / 33.0 Ah	4395	\$340.00
ME500VA, ME700VA, ME850VA	12 Volt / 33.0 Ah	1395	\$85.00
<b>BEST POWER - FERRUPS - MX</b>			
MX1KVA	12 Volt / 33.0 Ah	4395	\$340.00
<b>BEST POWER - FORTRESS</b>			
LI1050VA	12 Volt / 8.5 Ah	4390	\$132.00
LI2.0KVA, LI1.7KVA, LI1.8KVA	12 Volt / 33.0 Ah	2395	\$170.00
LI2250VA	6 Volt / 13.5 Ah	8380	\$160.00
LI2.5KVA	12 Volt / 33.0 Ah	3395	\$255.00
LI3.0KVA, LI5.0KVA	12 Volt / 33.0 Ah	3395	\$255.00
LI360VA, LI460VA	12 Volt / 5.5 Ah	2388	\$66.00
LI660VA, LI675VA, LI750VA	12 Volt / 8.5 Ah	2390	\$66.00
LI950VA, LI1020VA	6 Volt / 13.5 Ah	4380	\$80.00
<b>BEST POWER - FORTRESS - II</b>			
LI1020VA, LI520VA, LI720VA	12 Volt / 8.5 Ah	2390	\$66.00
LI2250VA	6 Volt / 13.5 Ah	8380	\$160.00
<b>BEST POWER - FORTRESS - RACKMOUNT</b>			
LI1050VA, LI1425VA	12 Volt / 8.5 Ah	3390	\$99.00
LI1800VA, LI2250VA	6 Volt / 13.5 Ah	8380	\$160.00
<b>BEST POWER - PATRIOT - PRO II</b>			
0325-0400U	12 Volt / 8.5 Ah	1390	\$33.00
0325-0750U	12 Volt / 8.5 Ah	2390	\$66.00
0325-1000U	6 Volt / 13.5 Ah	3380	\$60.00
<b>BEST POWER - PATRIOT - SMT</b>			
SMT280	12 Volt / 8.5 Ah	1390	\$33.00
SMT420	12 Volt / 8.5 Ah	1390	\$33.00
<b>BEST POWER - PATRIOT - SPI</b>			
SPI250, SPI1400, SPI1450	12 Volt / 8.5 Ah	1390	\$33.00
SPI600	6 Volt / 13.5 Ah	2380	\$40.00
<b>BEST POWER - PATRIOT - SPS</b>			
SPS250, SPS300, SPS450	12 Volt / 8.5 Ah	1390	\$33.00
SPS650	6 Volt / 13.5 Ah	2380	\$40.00
SPS850	12 Volt / 8.5 Ah	2390	\$66.00
<b>BEST POWER - UNITY - SINGLE PHASE</b>			
UT3K	12 Volt / 33.0 Ah	4395	\$340.00
UT3K	12 Volt / 33.0 Ah	8395	\$680.00
UT3K	12 Volt / 100 Ah	5987	\$215.00
UT4K	12 Volt / 33.0 Ah	8395	\$680.00
UT4K	12 Volt / 100 Ah	5987	\$215.00
UT4K	12 Volt / 33.0 Ah	4395	\$340.00
UT5K	12 Volt / 33.0 Ah	8395	\$680.00
UT5K	12 Volt / 33.0 Ah	4395	\$340.00
UT5K	12 Volt / 75.0 Ah	4901	\$700.00
UT8K	12 Volt / 75.0 Ah	4901	\$700.00
<b>DELTEC - PRA</b>			
PRA1000, PRA1500, PRA2000, PRA2200	12 Volt / 18.0 Ah	2391	\$130.00
PRA400, PRA600	12 Volt / 8.5 Ah	2390	\$66.00
<b>DELTEC - PRB</b>			

UPS

**EATON (BEST POWER, DELTEC, EXIDE, POWERWARE) ... continued from previous page****DELTEC - PRB ... continued from previous page**

PRB220, PRB300	12 Volt / 8.5 Ah	1390	\$33.00
PRB250, PRB400, PRB420	6 Volt / 4.5 Ah	2374	\$28.00
PRB500	12 Volt / 12.0 Ah	1551	\$45.00
PRB650	6 Volt / 13.5 Ah	2614	\$40.00

**DELTEC - PRM**

PRM1000	6 Volt / 13.5 Ah	4380	\$80.00
PRM1500	12 Volt / 5.5 Ah	2388	\$66.00
PRM450	12 Volt / 8.5 Ah	1390	\$33.00
PRM700	12 Volt / 12.0 Ah	1551	\$45.00

**EATON 3105**

3105 350, 3105 500	12 Volt / 5.5 Ah	1388	\$33.00
3105 700	12 Volt / 8.5 Ah	1390	\$33.00

**EATON 5115**

5115 1400, 5115 1500	12 Volt / 8.5 Ah	3390	\$99.00
5115 500	12 Volt / 8.5 Ah	1390	\$33.00
5115 750, 5115 1000	12 Volt / 8.5 Ah	2390	\$66.00

**EATON 5115 RACKMOUNT**

5115 1000 RM	6 Volt / 7.0 Ah	4375	\$56.00
5115 1500 RM	6 Volt / 7.0 Ah	6375	\$84.00
5115 500 RM	6 Volt / 7.0 Ah	2375	\$28.00

**EATON 5125**

5125 1000	12 Volt / 8.5 Ah	2390	\$66.00
5125 1500	12 Volt / 8.5 Ah	4390	\$132.00
5125 2200	12 Volt / 12.0 Ah	4551	\$180.00

**EATON 5125 RACKMOUNT**

5125 1000 RM, 5125 1500 RM	12 Volt / 8.5 Ah	4390	\$132.00
5125 2400 RM, 5125 3000 RM	12 Volt / 5.0 Ah	10388	\$330.00
5125 5000RM, 5125 6000RM	12 Volt / 5.0 Ah	20388	\$660.00

**EXIDE - PRESTIGE**

Prestige 1000	12 Volt / 5.5 Ah	55388	\$165.00
Prestige 3K, Prestige 6K	12 Volt / 5.0 Ah	10388	\$330.00
Prestige 650, Prestige 800	12 Volt / 5.5 Ah	4388	\$132.00

**POWERWARE**

PW3105 350, PW3105 500	12 Volt / 5.5 Ah	1388	\$33.00
PW3105 700, PW3110 425, PW3110 550, PW3110 700, PW3115 300	12 Volt / 8.5 Ah	1390	\$33.00
PW3110 300	6 Volt / 4.5 Ah	2374	\$28.00
PW3115 420	12 Volt / 8.5 Ah	2390	\$66.00
PW3115 650	6 Volt / 13.5 Ah	1614	\$20.00
PW5105 1000	6 Volt / 13.5 Ah	4380	\$80.00
PW5105 1500	12 Volt / 18.0 Ah	2391	\$130.00
PW5105 450, PW5110 750	12 Volt / 8.5 Ah	1390	\$33.00
PW5105 700	6 Volt / 13.5 Ah	1614	\$20.00
PW5110 1000, PW5110 1500	12 Volt / 8.5 Ah	2390	\$66.00
PW5110 350, PW5110 500	12 Volt / 5.5 Ah	1388	\$33.00
PW5119 1000	12 Volt / 8.5 Ah	4390	\$132.00
PW5119 1500	12 Volt / 18.0 Ah	2391	\$130.00
PW5119 2000	6 Volt / 13.5 Ah	8614	\$160.00
PW5119 2400, PW5119 3000	12 Volt / 18.0 Ah	4391	\$260.00
PW9120 1000	12 Volt / 8.5 Ah	3390	\$99.00

**EATON (BEST POWER, DELTEC, EXIDE, POWERWARE) ... continued from previous page**

<b>POWERWARE ... continued from previous page</b>			
PW9120 1500, PW9120 2000, PW9125 1250, PW9125 1500, PW9125 2000	12 Volt / 8.5 Ah	4390	\$132.00
PW9120 3000	12 Volt / 8.5 Ah	8390	\$265.00
PW9120 700	12 Volt / 8.5 Ah	2390	\$66.00
PW9125 3000	12 Volt / 8.5 Ah	6390	\$198.00
PW9125 6000	12 Volt / 7.0 Ah	20390	\$660.00
PW9125 700, PW9125 1000	12 Volt / 8.5 Ah	2390	\$66.00

**FALCON**

FN10K-2TXI, FN10KRM-2TXI, FN8KRM-2TXI, FN8K-2TXI	12 Volt / 9.0 Ah	20986	\$680.00
FN3K-2TXI, FN3KRM-2TXI, FN4K-2TXI, FN4KRM-2TXI	12 Volt / 7.0 Ah	20390	\$660.00
FN6K-2TXI, FN6KRM-2TXI	12 Volt / 7.0 Ah	20390	\$660.00
SG1.5K-1T, SG2K-1T, SG2K-2T-HW, SG2K-2T, SG2K-1T-HW	12 Volt / 8.5 Ah	6390	\$198.00
SG2KRM-2TU, SG2KRM-1TU, SG2K-X2T, SG2K-X1T	12 Volt / 8.5 Ah	6390	\$198.00
SG3K-1TX, SG3K-1T-HW, SG3K-1T, SG2K-2TXI, SG2K-2TX	12 Volt / 8.5 Ah	8390	\$265.00
SG3K-2T, SG3K-2T-HW, SG3K-X1T	12 Volt / 8.5 Ah	8390	\$265.00
SG3KRM-1TU, SG3KRM-2TU, SG3K-2TX, SG3K-2TXI	12 Volt / 8.5 Ah	8390	\$265.00
SG5K-1TX, SG5K-1TXC, SG5K-2T, FN5K-2TXI, FN5KRM-2TXI	12 Volt / 7.0 Ah	20390	\$660.00
SG5K-2TC, SG5K-2TX, SG5K-2TXC, SG5K-X1T, SG5K-X2T, SG5K-X2TC	12 Volt / 7.0 Ah	20390	\$660.00
SG6K-1TX, SG6K-2T, SG6K-2TC, SG6K-2TX, SG6K-2TXV, SG6K-X1T, SG6K-X2T, SG6K-X2TC	12 Volt / 7.0 Ah	20390	\$660.00
SG800-1T, SG1K-1T, SG1K-2T, SG1KRM-1TU, SG1KRM-2TU	12 Volt / 8.5 Ah	3390	\$99.00
SSG1.5K-1T, SSG1.5K-2T, SSG1.5KRM-1, SSG1.5KRM-2	12 Volt / 8.5 Ah	4390	\$132.00
SSG1.5KRP-1, SSG1.5KRP-2, SSG2KRP-1, SSG2KRP-2	12 Volt / 5.5 Ah	8388	\$264.00
SSG2.2K-1T, SSG2.2K-2T, SG2K-1TX, SG3K-X2T, SSG2.2KRM-1, SSG2.2KRM-2	12 Volt / 8.5 Ah	8390	\$265.00
SSG2.5KRP-1, SSG2.5KRP-2, SSG3KRP-1, SSG3KRP-2	12 Volt / 5.5 Ah	8388	\$264.00
SSG3K-1T, SSG3K-2T, SG3K-2TX, SG3K-2TXI, SSG3KRM-1, SSG3KRM-2	12 Volt / 8.5 Ah	8390	\$265.00

**FENTON**

1200VA, 1500VA, S1000	12 Volt / 8.5 Ah	2390	\$66.00
600VA, 800VA, L425	12 Volt / 8.5 Ah	1390	\$33.00
B2411, L1000, L1000X, L1400, L1400X, L1400R	12 Volt / 12.0 Ah	2551	\$90.00
B3611	12 Volt / 12.0 Ah	3551	\$135.00
H4000	12 Volt / 8.5 Ah	16390	\$530.00
H6000, H8000, H010K	12 Volt / 18.0 Ah	16391	\$1,040.00
HE8806, HE8810, HE38810, HE38815, HE38820, HE38830	12 Volt / 18.0 Ah	16391	\$1,040.00
L280	6 Volt / 4.5 Ah	1374	\$14.00
L660	6 Volt / 4.5 Ah	2374	\$28.00
M2000, M2000R	12 Volt / 8.5 Ah	6390	\$198.00
ME9010	12 Volt / 9.0 Ah	20986	\$680.00
ME901, M1000, M1000R, S1500	12 Volt / 8.5 Ah	3390	\$99.00
ME902, ME903, M3000, M3000R	12 Volt / 8.5 Ah	8390	\$265.00
ME906	12 Volt / 7.0 Ah	20390	\$660.00
S2000	12 Volt / 8.5 Ah	4390	\$132.00
S300A, S450A	12 Volt / 5.4 Ah	1984	\$36.00

UPS

**HEWLETT PACKARD (COMPAQ)**

L1000, L1250, R1500, T1500XR	12 Volt / 8.5 Ah	4390	\$132.00
L2100	12 Volt / 8.5 Ah	8390	\$265.00
L600, L900	12 Volt / 8.5 Ah	2390	\$66.00
R3000	6 Volt / 13.5 Ah	16380	\$320.00
R3000XR	12 Volt / 5.0 Ah	10388	\$330.00
R6000	12 Volt / 5.0 Ah	28388	\$924.00
T1000	6 Volt / 13.5 Ah	4380	\$80.00
T1500	12 Volt / 8.5 Ah	3390	\$99.00
T2000	6 Volt / 13.5 Ah	8380	\$160.00
T700	12 Volt / 12.0 Ah	1551	\$45.00

**IBM**

NP700, NP700i, OP700i	6 Volt / 13.5 Ah	2380	\$40.00
OP500, OP500AVR, OP500AVRi, OP500i	12 Volt / 8.5 Ah	1390	\$33.00
OP700, OP700AVR, OP700AVRi	6 Volt / 13.5 Ah	2380	\$40.00
OP700, OP700i, OP700AVR, OP700AVRi	12 Volt / 8.5 Ah	1390	\$33.00

**INTELLIPOWER****INTELLIPOWER - COMMERCIAL**

IHT1500RM-C-1.05kw-DiAC-Isol-5060-120v-4BFB-3U24	12 Volt / 9.0 Ah	4986	\$136.00
IHT1500RM-C-1.05kw-DiAC-Isol-5060-120v-4BHS-3U20	12 Volt / 9.0 Ah	4986	\$136.00
IHT3000RM-C-2.1kw-120v-5060-120v-6BFB-3U20	12 Volt / 9.0 Ah	6986	\$204.00
IQ1100RM-C-0.74kw-120v-50-60Hz-120v-3BFB-2U18	12 Volt / 9.0 Ah	3986	\$102.00
IQ1100RM-C-0.74kw-120v-50-60Hz-120v-4BFB-2U18	12 Volt / 9.0 Ah	4986	\$136.00
IQ1500RM-C-1.05kw-120v-50/60-120v-5BFB-2U18	12 Volt / 9.0 Ah	55986	\$170.00
IQ1500RM-C-1.05kw-120v-50-60Hz-120v-4BFB-2U21	12 Volt / 9.0 Ah	4986	\$136.00
IQ1500RM-C-1.05kw-120v-50-60Hz-120v-4BFB-3U20	12 Volt / 9.0 Ah	4986	\$136.00
IQ1500RM-C-1.05kw-120v-FC60-120v-4BHS-2U21	12 Volt / 9.0 Ah	4986	\$136.00
IQ1500RM-C-1.05kw-DiAC-Isol-5060-120v-4BFB-3U20	12 Volt / 9.0 Ah	4986	\$136.00
IQ2000RM-C-1.4kw-120v-FC60-120v-5BFB-2U21	12 Volt / 9.0 Ah	55986	\$170.00
IQ2000RM-C-1.4kw-120v-FC60-120v-5BFB-3U20	12 Volt / 9.0 Ah	55986	\$170.00
IQ2000RM-C-1.4kw-DiAC-Isol-50/60-120v-5BFB-3U20	12 Volt / 9.0 Ah	55986	\$170.00
IQ2000RM-C-1.4kw-DiAC-Isol-50/60-120v-5BFB-3U24	12 Volt / 9.0 Ah	55986	\$170.00
IQ3000RM-C-2.1kw-120v-5060-120v-7BFB-3U20	12 Volt / 9.0 Ah	7986	\$238.00
IQ3000RM-C-2.1kw-120v-50/60Hz-120v-10BFB-3U22.2	12 Volt / 9.0 Ah	7986	\$238.00
IQ3000RM-C-2.1kw-120v-FC60-120v-6BFB-2U24	12 Volt / 9.0 Ah	6986	\$204.00
IQ3000RM-C-2.1kw-120v-FC60-120v-7BHS-2U26	12 Volt / 9.0 Ah	7986	\$238.00
IQ3000RM-C-2.1kw-120v-FC60-120v-7BHS-2U26	12 Volt / 9.0 Ah	7986	\$238.00
IQ3000RM-C-2.1kw-DiAC-Isol-FC60-120v-6BFB-3U24	12 Volt / 9.0 Ah	6986	\$204.00
IQ3000RM-C-2.1kw-DiAC-Isol-FC60-120v-7BFB-3U24	12 Volt / 9.0 Ah	7986	\$238.00
IQ3000RM-C-2.1kw-DiAC-Isol-FC60-120v-7BHS-3U24	12 Volt / 9.0 Ah	7986	\$238.00
IQ650RM-C-0.45kw-120v-120v-2BFB-2U18	12 Volt / 8.5 Ah	2390	\$66.00
IQ800RM-C-0.56kw-120v-120v-2BFB-2U18	12 Volt / 9.0 Ah	2986	\$68.00
IQ800RM-C-0.56kw-120v-5060-120v-3BFB-2U18	12 Volt / 9.0 Ah	3986	\$102.00

**INTELLIPOWER - INDUSTRIAL**

IHT1100RM-I-0.74kw-DiAC-Isol-FC60-120v-3BFB-2U18	12 Volt / 9.0 Ah	3986	\$102.00
IHT1100RM-I-0.74kw-DiAC-Isol-FC60-120v-3BHS-2U18	12 Volt / 9.0 Ah	3986	\$102.00
IHT1100RM-I-0.74kw-DiAC-Isol-FC60-120v-4BHS-2U21	12 Volt / 9.0 Ah	4986	\$136.00
IHT1100RM-I-740kw-120v-Isol-50-60Hz-120v-3BFB-2U18	12 Volt / 9.0 Ah	3986	\$102.00
IHT1100RM-I-740kw-120v-Isol-FC60-120v-4BFB-2U24	12 Volt / 9.0 Ah	4986	\$136.00
IHT1100RM-I-745kw-120v-50-60Hz-120v-3BFB-2U18	12 Volt / 9.0 Ah	3986	\$102.00
IHT1100RM-I-74kw-120v-50-60Hz-120v-4BFB-2U21	12 Volt / 9.0 Ah	4986	\$136.00
IHT1100RM-M-.74kw-DiAC-Isol-FC60-120v-4BFB-2U21	12 Volt / 9.0 Ah	4986	\$136.00

<b>INTELLIPOWER ... continued from previous page</b>			
<b>INTELLIPOWER - INDUSTRIAL ... continued from previous page</b>			
IHT1500RM-I-1.05kw-120v-5060-120v-4BFB-2U21	12 Volt / 9.0 Ah	4986	\$136.00
IHT1500RM-I-1.05kw-120v-5060-120v-4BFB-3U20	12 Volt / 9.0 Ah	4986	\$136.00
IHT1500RM-I-1.05kw-120v-5060-120v-4BHS-2U21	12 Volt / 9.0 Ah	4986	\$136.00
IHT1500RM-I-1.05kw-120v-Isol-FC60-120v-4BFB-3U20	12 Volt / 9.0 Ah	4986	\$136.00
IHT1500RM-I-1.05kw-120v-Isol-FC60-120v-4BHS-3U20	12 Volt / 9.0 Ah	4986	\$136.00
IHT2000RM-I-1.4kw-120v-5060-120v-5BFB-3U20	12 Volt / 9.0 Ah	55986	\$170.00
IHT2000RM-I-1.4kw-120v-5060-120v-5BHS-3U20	12 Volt / 9.0 Ah	55986	\$170.00
IHT2000RM-I-1.4kw-120v-50-60Hz-120v-5BFB-2U21	12 Volt / 9.0 Ah	55986	\$170.00
IHT2000RM-I-1.4kw-120v-Isol-FC60-120v-5BFB-3U20	12 Volt / 9.0 Ah	55986	\$170.00
IHT2000RM-I-1.4kw-DiAC-Isol-50/60-120v-5BFB-3U24	12 Volt / 9.0 Ah	55986	\$170.00
IHT2000RM-I-2kw-DiAC-Non.Isol-50/60-120/240v-5BFB-3U24	12 Volt / 9.0 Ah	6986	\$204.00
IHT2000RM-I-2kw-DiAC-Non.Isol-50/60-240v-5BFB-3U24	12 Volt / 9.0 Ah	6986	\$204.00
IHT3000RM-I-2.1kw-120v-5060-120v-6BFB-2U24	12 Volt / 9.0 Ah	6986	\$204.00
IHT3000RM-I-2.1kw-120v-5060-120v-7BFB-2U26	12 Volt / 9.0 Ah	7986	\$238.00
IHT3000RM-I-2.1kw-120v-5060-120v-7BFB-3U20	12 Volt / 9.0 Ah	7986	\$238.00
IHT3000RM-I-2.1kw-120v-FC60-120v-7BFB-3U20	12 Volt / 9.0 Ah	7986	\$238.00
IHT3000RM-I-2.1kw-120v-Isol-FC60-120v-6BFB-3U24	12 Volt / 9.0 Ah	6986	\$204.00
IHT3000RM-I-2.1kw-120v-Isol-FC60-120v-7BHS-3U24	12 Volt / 9.0 Ah	7986	\$238.00
IHT3000RM-I-2.1kw-DiAC-Isol-FC60-120v-6BFB-3U24	12 Volt / 9.0 Ah	6986	\$204.00
IHT3000RM-I-2.1kw-DiAC-Isol-FC60-120v-7BFB-3U24	12 Volt / 9.0 Ah	7986	\$238.00
IHT3000RM-I-2.1kw-DiAC-Isol-FC60-120v-7BHS-3U24	12 Volt / 9.0 Ah	7986	\$238.00
IHT500RM-I-.35kw-DiAC-Isol-FC60-120v-2BFB-2U18	12 Volt / 8.5 Ah	2390	\$66.00
IHT500RM-I-.35kw-DiAC-Isol-FC60-120v-2BHS-2U18	12 Volt / 8.5 Ah	2390	\$66.00
IHT650RM-I-0.45kw-120v-5060-120v-2BFB-2U18	12 Volt / 8.5 Ah	2390	\$66.00
IHT650RM-I-0.45kw-120v-Isol-120v-2BFB-2U18	12 Volt / 8.5 Ah	2390	\$66.00
IHT650RM-I-.45kw-DiAC-Isol-FC60-120v-2BFB-2U18	12 Volt / 8.5 Ah	2390	\$66.00
IHT650RM-I-.45kw-DiAC-Isol-FC60-120v-2BHS-2U18	12 Volt / 8.5 Ah	2390	\$66.00
IHT800RM-I-0.56kw-120v-5060-120v-2BFB-2U18	12 Volt / 9.0 Ah	2986	\$68.00
IHT800RM-I-0.56kw-120v-5060-120v-3BFB-2U18	12 Volt / 9.0 Ah	2986	\$68.00
IHT800RM-I-0.56kw-120v-Isol-120v-2BFB-2U18	12 Volt / 9.0 Ah	2986	\$68.00
IHT800RM-I-0.56kw-120v-Isol-FC60-120v-3BFB-2U18	12 Volt / 9.0 Ah	3986	\$102.00
IHT800RM-I-.56kw-DiAC-Isol-FC60-120v-2BFB-2U18	12 Volt / 9.0 Ah	2986	\$68.00
IHT800RM-I-.56kw-DiAC-Isol-FC60-120v-2BHS-2U18	12 Volt / 9.0 Ah	2986	\$68.00
IQ1100RM-Di-Isol-FC60-PFC-XR-3U16.75	12 Volt / 8.5 Ah	3390	\$99.00

<b>LIEBERT (EMERSON)</b>			
GX1000RT-120	12 Volt / 8.5 Ah	4390	\$132.00
GX1500RT-120	12 Volt / 8.5 Ah	6390	\$198.00
GX3000RT-240	12 Volt / 12.0 Ah	6551	\$270.00
GXT10000T-208, GXT10000T-208X, GXT10000T-240X	12 Volt / 8.5 Ah	40390	\$33.00
GXT1000MT-120, GXT1000RT-120	12 Volt / 8.5 Ah	3390	\$99.00
GXT1000RTE-120	12 Volt / 8.5 Ah	6390	\$198.00
GXT2000RT-120, GX2100RT-120, GXT3000RT-120	12 Volt / 8.5 Ah	8390	\$265.00
GXT2-10000RT208	12 Volt / 9.0 Ah	24986	\$816.00
GXT2-2000RT120	12 Volt / 9.0 Ah	4986	\$136.00
GXT2-3000RT120	12 Volt / 9.0 Ah	6986	\$204.00
GXT2-500RT120, GXT2-700RT120, GXT2-1000RT120, GXT2-1500RT120, GXT1500RT-120	12 Volt / 8.5 Ah	4390	\$132.00
GXT2-6000RT208	12 Volt / 9.0 Ah	12986	\$408.00
GXT6000T-208, GXT6000T-208X, GTX6000T-240X	12 Volt / 7.0 Ah	20390	\$660.00
GXT700MT-120	12 Volt / 8.5 Ah	2390	\$66.00
PA350-120U, PSP350MT3-120U	12 Volt / 5.5 Ah	1388	\$33.00

UPS



**LIEBERT (EMERSON) ... continued from previous page**

PA500-120U	12 Volt / 8.5 Ah	1390	\$33.00
PS1000MT-120, PS1000RM-120, PS1000RT3-120, PS1000RT3-120W	12 Volt / 8.5 Ah	3390	\$99.00
PS1000RT2-120, PS1000RT3-120XR, PS1000RT3-120XRW	12 Volt / 8.5 Ah	4390	\$132.00
PS1400MT-120, PS1400RM-120, PS1440RT2-120	12 Volt / 8.5 Ah	4390	\$132.00
PS1500RT3-120, PS1500RT3-120W	12 Volt / 9.0 Ah	3986	\$102.00
PS1500RT3-120XR, PS1500RT3-120XRW	12 Volt / 9.0 Ah	4986	\$136.00
PS1920RT2-120, PS2200RT2-120, PS2200RT3-120, PS2200RT3-120W	12 Volt / 8.5 Ah	6390	\$198.00
PS2200MT-120, PS2200RM-120	6 Volt / 13.5 Ah	8380	\$160.00
PS2200RT3-120XR, PS2200RT3-120XRW	12 Volt / 8.5 Ah	8390	\$265.00
PS250-60, PS250-60S	12 Volt / 5.5 Ah	1388	\$33.00
PS3000RT2-120, PS3000RT3-120, PS3000RT3-120W	12 Volt / 9.0 Ah	6986	\$204.00
PS3000RT3-120XR, PS3000RT3-120XRW	12 Volt / 9.0 Ah	8986	\$272.00
PS400-60, PS400-60S	12 Volt / 8.5 Ah	1390	\$33.00
PS600-60, PS600-60S, PS700MT-120, PS700RM-120	12 Volt / 8.5 Ah	2390	\$66.00
PSA1000MT-120	12 Volt / 8.5 Ah	2390	\$66.00
PSA350-120, PSA350MT-120, PSA470-120, PSA700-120	12 Volt / 8.5 Ah	1390	\$33.00
PSA500MT-120, PSA650MT-120	12 Volt / 9.0 Ah	1986	\$34.00
PSA500MT3-120U, PSA650MT3-120U	12 Volt / 8.5 Ah	1390	\$33.00
PSP300-115	12 Volt / 5.5 Ah	1388	\$33.00
PSP350MT-120, PSP500MT-120	12 Volt / 8.5 Ah	1390	\$33.00
PSP500-115, PSP500MT3-120U	12 Volt / 8.5 Ah	1390	\$33.00
PSP650MT-120	12 Volt / 9.0 Ah	1986	\$34.00
UD1400, UD1400R (Requires 6/unit)	6 Volt / 13.5 Ah	1380	\$20.00
UD2000, UD2000R	12 Volt / 18.0 Ah	3391	\$195.00
UD600, UD600R	12 Volt / 8.5 Ah	2390	\$66.00
UD900, UD900R	6 Volt / 13.5 Ah	4380	\$80.00

**MASTERGUARD**

A1000T	12 Volt / 8.5 Ah	3390	\$99.00
--------	------------------	------	---------

**MERICH**

350, 400, UPS400	12 Volt / 8.5 Ah	2390	\$66.00
850C	12 Volt / 8.5 Ah	4390	\$132.00
M1200	12 Volt / 8.5 Ah	6390	\$198.00
M1400	12 Volt / 24.0 Ah	1393	\$70.00

**MGE**

EL2, EL4, ES2, ES4, ESV3, ESV5, ES2+, ES5+, ESV5+, Evolution 500	6 Volt / 7.0 Ah	2375	\$28.00
EL7, ES7, ESV8, ES8+, ESV8+	12 Volt / 8.5 Ah	2390	\$66.00
ES10, ESV11	6 Volt / 13.5 Ah	3380	\$60.00
ES11+, ESV11+, Evolution 1500, EX10	12 Volt / 8.5 Ah	3390	\$99.00
ESV14+, ESV13, EX15, ESV22	12 Volt / 8.5 Ah	4390	\$132.00
ESV17, ESV20	12 Volt / 18.0 Ah	4391	\$260.00
ESV22+	12 Volt / 12.0 Ah	4551	\$180.00
Evolution 1100	6 Volt / 7.0 Ah	4375	\$56.00
Evolution 2200, Evolution 3000	12 Volt / 9.0 Ah	6986	\$204.00
EX20, EX30	12 Volt / 8.5 Ah	8390	\$265.00
EX7	12 Volt / 8.5 Ah	2390	\$66.00
EXL10	12 Volt / 8.5 Ah	40390	\$33.00

<b>MINUTEMAN (PARA SYSTEMS, INC.)</b>			
A2000 (Requires 6/unit)	6 Volt / 13.5 Ah	1380	\$20.00
A300, A300/2, A300L, A425, A425/2	12 Volt / 8.5 Ah	1390	\$33.00
A500, A500/2	6 Volt / 13.5 Ah	2380	\$40.00
A750, A750/2	12 Volt / 8.5 Ah	2390	\$66.00
A900, A900/2, A1250, A1250/2	6 Volt / 13.5 Ah	4380	\$80.00
BP120V13	12 Volt / 7.0 Ah	20390	\$660.00
BP120V6.5I	12 Volt / 7.0 Ah	10390	\$330.00
BP144V13	12 Volt / 8.5 Ah	24390	\$792.00
BP144V6.5I	12 Volt / 8.5 Ah	12390	\$396.00
BP192V17	12 Volt / 18.0 Ah	16391	\$1,040.00
BP24V10, MM500	6 Volt / 13.5 Ah	4380	\$80.00
BP24V20, BP48V10	6 Volt / 13.5 Ah	8380	\$160.00
BP48V13	12 Volt / 8.5 Ah	8390	\$265.00
BP48V17A, BPX48V17, BP24V34, BP48V17/20	12 Volt / 18.0 Ah	4391	\$260.00
BP48V34	12 Volt / 18.0 Ah	8391	\$520.00
BP60V17	12 Volt / 18.0 Ah	55391	\$3,575.00
CP10000, CP12500	12 Volt / 8.5 Ah	48390	\$1,584.00
CP10K/2	12 Volt / 18.0 Ah	16391	\$1,040.00
CP1K, CP1KA, CP1K/2+	12 Volt / 7.0 Ah	55390	\$165.00
CP2K/2, CP3000, CPR3000, CP3200, CPR3200	12 Volt / 7.0 Ah	10390	\$330.00
CP3K, CP3K/2	12 Volt / 8.5 Ah	12390	\$396.00
CP500, CP500+, CP500/2	12 Volt / 8.5 Ah	2390	\$66.00
CP6000	12 Volt / 7.0 Ah	20390	\$660.00
CP8000	12 Volt / 8.5 Ah	24390	\$792.00
CPE1000, CPE1000RM	12 Volt / 8.5 Ah	3390	\$99.00
CPE2000, CPE2000RM	12 Volt / 8.5 Ah	6390	\$198.00
CPE3000, CPE3000RM	12 Volt / 8.5 Ah	8390	\$265.00
CPEBP1000	12 Volt / 8.5 Ah	9390	\$297.00
CPEBP1000RM	12 Volt / 8.5 Ah	6390	\$198.00
CPEBP2000	12 Volt / 8.5 Ah	18390	\$594.00
CPEBP2000RM	12 Volt / 8.5 Ah	12390	\$396.00
CPEBP3000, CPEBP3000RM	12 Volt / 8.5 Ah	16390	\$530.00
E1100, E1100I	12 Volt / 5.5 Ah	4388	\$132.00
E1500, E1500I, EBP1	12 Volt / 8.5 Ah	4390	\$132.00
E2000RM2U, E3000RM2U, E3000RMT2U, EBP36XL, EBP72XL	12 Volt / 8.5 Ah	6390	\$198.00
E2300, E2300I, E3200, E3200I, EBP2	12 Volt / 12.0 Ah	4551	\$180.00
E500, E500I	12 Volt / 5.5 Ah	2388	\$66.00
E700RM1U, E1000RM1U, E1500RM1U	6 Volt / 7.0 Ah	4375	\$56.00
E750, E750I	12 Volt / 8.5 Ah	2390	\$66.00
E750RM2U, E1000RM2U, E1500RM2U, E1500RMT2U	12 Volt / 8.5 Ah	3390	\$99.00
EBP3	12 Volt / 8.5 Ah	8390	\$265.00
EBP36EXL, EBP72EXL	12 Volt / 8.5 Ah	18390	\$594.00
EBP4	12 Volt / 12.0 Ah	8551	\$360.00
ED10000T, ED10200T	12 Volt / 9.0 Ah	20986	\$680.00
ED1000RM2U, ED1000RMT2U	12 Volt / 8.5 Ah	2390	\$66.00
ED1500RM2U, ED1500RMT2U, ED2000RM2U, ED2000RMT2U, EDBP24XL	12 Volt / 8.5 Ah	4390	\$132.00
ED3000RM2U, ED3000RMT2U	12 Volt / 8.5 Ah	6390	\$198.00
ED6000T, ED6200T	12 Volt / 7.0 Ah	20390	\$660.00
EDBP10000T	12 Volt / 9.0 Ah	40986	\$1,360.00
EDBP24EXL, EDBP48EXL	12 Volt / 7.0 Ah	20390	\$660.00
EDBP48XL	12 Volt / 8.5 Ah	8390	\$265.00
EDBP6000RM	12 Volt / 7.0 Ah	20390	\$660.00
EDBP72EXL	12 Volt / 8.5 Ah	18390	\$594.00

UPS

**MINUTEMAN (PARA SYSTEMS, INC.) ... continued from previous page**

EDBP72XL	12 Volt / 8.5 Ah	6390	\$198.00
EN400, EN600	12 Volt / 5.5 Ah	1388	\$33.00
EN750, EN900	12 Volt / 8.5 Ah	1390	\$33.00
ETR1000, ETR1500, ETR1500P15	12 Volt / 8.5 Ah	2390	\$66.00
ETR500	12 Volt / 5.5 Ah	1388	\$33.00
ETR700, ETR700P15	12 Volt / 8.5 Ah	1390	\$33.00
MBK300, MBK300I	12 Volt / 5.5 Ah	1388	\$33.00
MBK320, MBK320I, MBK520, MBK520I	12 Volt / 8.5 Ah	1390	\$33.00
MBK550E	12 Volt / 8.5 Ah	1390	\$33.00
MBK680, MBK680I	12 Volt / 12.0 Ah	1551	\$45.00
MBK750E	12 Volt / 8.5 Ah	2390	\$66.00
MCP1000E, MCP1000IE, MCP1000IRME, MCP1000RME	12 Volt / 8.5 Ah	3390	\$99.00
MCP1000, MCP1000I	12 Volt / 8.5 Ah	4390	\$132.00
MCP2000E, MCP2000IE, MCP2000IRME, MCP2000RME	12 Volt / 8.5 Ah	6390	\$198.00
MCP2000, MCP2000I	12 Volt / 8.5 Ah	6390	\$198.00
MCP3000E, MCP3000IE, MCP3000IRME, MCP3000RME	12 Volt / 8.5 Ah	8390	\$265.00
MCP3000, MCP3000I	12 Volt / 8.5 Ah	8390	\$265.00
MCP5000IE	12 Volt / 7.0 Ah	20390	\$660.00
MCP6000, MCP6001	12 Volt / 7.0 Ah	20390	\$660.00
MCP7000IE, MCPBP3000	12 Volt / 8.5 Ah	24390	\$792.00
MCP700E, MCP700IE, MCP700IRME, MCP700RME	12 Volt / 8.5 Ah	3390	\$99.00
MCP8000, MCP8001, MCP10000, MCP10001	12 Volt / 8.5 Ah	40390	\$33.00
MCPBP1000, MCPBP1000RM	12 Volt / 8.5 Ah	6390	\$198.00
MCPBP2	12 Volt / 8.5 Ah	12390	\$396.00
MCPBP2000	12 Volt / 8.5 Ah	18390	\$594.00
MCPBP2000RM	12 Volt / 8.5 Ah	12390	\$396.00
MCPBP3	12 Volt / 8.5 Ah	16390	\$530.00
MCPBP3000RM	12 Volt / 8.5 Ah	16390	\$530.00
MCPBP5000, MCPBP7000	12 Volt / 8.5 Ah	40390	\$33.00
MCPBP7000	12 Volt / 8.5 Ah	48390	\$1,584.00
MM1KCP/1, MM1KCP/2	12 Volt / 7.0 Ah	55390	\$165.00
MM250AC, MM250XL/1, MM250XL/2, MM250/2AC	12 Volt / 8.5 Ah	1390	\$33.00
MM2K/2	12 Volt / 7.0 Ah	10390	\$330.00
MM3000CP/1, MM3000CP/2	12 Volt / 8.5 Ah	16390	\$530.00
MM300SS/1, MM300AC, MM450	12 Volt / 8.5 Ah	2390	\$66.00
MM500CP/1, MM500CP/2	12 Volt / 8.5 Ah	2390	\$66.00
MM600SS/1, MM600SS/2, MM850, MM850/2	12 Volt / 8.5 Ah	4390	\$132.00
MN325	12 Volt / 3.4 Ah	1384	\$25.00
MN525	12 Volt / 8.5 Ah	1390	\$33.00
MSU1000, MSU1000I	12 Volt / 12.0 Ah	2551	\$90.00
MSU1400, MSU1400I	12 Volt / 18.0 Ah	2391	\$130.00
MSU700, MSU700I	12 Volt / 8.5 Ah	2390	\$66.00
PML1650, PML2000, PML2000/2	12 Volt / 18.0 Ah	4391	\$260.00
PML600, PML600/2	12 Volt / 8.5 Ah	2390	\$66.00
PML900, PML900/2, PML1250, PML1250/2	12 Volt / 8.5 Ah	4390	\$132.00
PRO1000, PRO1000I	12 Volt / 12.0 Ah	2551	\$90.00
PRO1000R, PRO1000RI, PRO1400R, PRO1400RI	12 Volt / 8.5 Ah	4390	\$132.00
PRO1000RT	12 Volt / 9.0 Ah	2986	\$68.00
PRO1100E, PRO1100IE	12 Volt / 8.5 Ah	3390	\$99.00
PRO1400, PRO1400I	12 Volt / 18.0 Ah	2391	\$130.00
PRO1500E, PRO1500IE, PRO1500RT	12 Volt / 9.0 Ah	3986	\$102.00
PRO200, PRO200I	12 Volt / 5.5 Ah	1388	\$33.00
PRO2200R, PRO2200RI	12 Volt / 12.0 Ah	4551	\$180.00
PRO280, PRO280I, PRO320, PRO320I	12 Volt / 8.5 Ah	1390	\$33.00

<b>MINUTEMAN (PARA SYSTEMS, INC.) ... continued from previous page</b>			
PRO420, PRO420I, PRO520, PRO520I	12 Volt / 8.5 Ah	1390	\$33.00
PRO500E, PRO500IE	12 Volt / 9.0 Ah	1986	\$34.00
PRO650, PRO650I, PRO700, PRO700I	12 Volt / 12.0 Ah	1551	\$45.00
PRO700E, PRO700IE, PRO700R, PRO700RI	12 Volt / 8.5 Ah	2390	\$66.00
PROBPRI	12 Volt / 18.0 Ah	4391	\$260.00
PX10/0.3, PX10/0.4	12 Volt / 8.5 Ah	1390	\$33.00
PX10/0.60	12 Volt / 12.0 Ah	1551	\$45.00
PX10/1.0	12 Volt / 12.0 Ah	2551	\$90.00
PX10/1.0R, PX10/1.4R, PX10/.6S	12 Volt / 8.5 Ah	4390	\$132.00
PX10/1.4	12 Volt / 18.0 Ah	2391	\$130.00
PX10/2.2R	12 Volt / 12.0 Ah	4551	\$180.00
PX10/.7R	12 Volt / 8.5 Ah	2390	\$66.00
S1000	12 Volt / 12.0 Ah	2551	\$90.00
S1400, S2000	12 Volt / 18.0 Ah	2391	\$130.00
S700	12 Volt / 8.5 Ah	2390	\$66.00
XRT600, XRT600/2	12 Volt / 8.5 Ah	4390	\$132.00
XRTBP1	12 Volt / 18.0 Ah	4391	\$260.00
XRTBP3	12 Volt / 100 Ah	5987	\$215.00

**ONEAC (CHLORIDE)**

AG0K7XAU, AG1K0XAU, AG1K5XAU	12 Volt / 8.5 Ah	3390	\$99.00
AG2K0XAU, AG3K0XAU	12 Volt / 8.5 Ah	6390	\$198.00
DESK POWER 300, DESK POWER 500	12 Volt / 5.5 Ah	1388	\$33.00
DESK POWER 650	12 Volt / 9.0 Ah	1986	\$34.00
ON1500XAU-SN, ON1500XIU-SN	12 Volt / 5.5 Ah	4388	\$132.00
ON2000XAU-SN, ON2000XIU-SN, ON2000XAU-CN, ON2000XAU-TN	12 Volt / 5.5 Ah	8388	\$264.00
ON700XAU-SN, ON700XIU-SN, ON1000XAU-SN, ON1000XIU-SN	12 Volt / 5.5 Ah	4388	\$132.00
ONE1004AG-SE	12 Volt / 8.5 Ah	3390	\$99.00
ONE200A-SB, ONE300A-SB	12 Volt / 8.5 Ah	1390	\$33.00
ONE200DA-SB	6 Volt / 13.5 Ah	2380	\$40.00
ONE254AG-SE	12 Volt / 8.5 Ah	1390	\$33.00
ONE300DA-SB, ONE400DA-SB, ONE600XA-SB	12 Volt / 8.5 Ah	2390	\$66.00
ONE404AG-SE	12 Volt / 9.0 Ah	1986	\$34.00
ONE604AG-SE	12 Volt / 8.5 Ah	2390	\$66.00
ONEXBC-217	12 Volt / 18.0 Ah	2391	\$130.00
ONM300DA-SI, ONM300DJ-SI, ONM300DI-SI	12 Volt / 8.5 Ah	2390	\$66.00
ONM300J-SI, ONM300I-SI	12 Volt / 8.5 Ah	1390	\$33.00
ONM600XA-SI, ONM600XJ-SI, ONM600XI-SI	12 Volt / 8.5 Ah	2390	\$66.00
ONMXBC-217	12 Volt / 18.0 Ah	2391	\$130.00
ONXBCU-147	12 Volt / 18.0 Ah	4391	\$260.00
S0K7XAU, S1K0XAU	12 Volt / 8.5 Ah	3390	\$99.00
S1K5XAU	12 Volt / 9.0 Ah	3986	\$102.00
S2K0XHU, S2K0XAU, SBP1K5-2	12 Volt / 8.5 Ah	6390	\$198.00
S3K0XAU, S3K0XHU	12 Volt / 9.0 Ah	6986	\$204.00
SBP3K0-2	12 Volt / 9.0 Ah	12986	\$408.00
SE041XAT, SE041XIT, SE041XJT	12 Volt / 7.0 Ah	20390	\$660.00
SE061XAT, SE061XIT, SE061XJT	12 Volt / 7.0 Ah	20390	\$660.00
SE081XAT, SE081XIT, SE081XJT	12 Volt / 9.0 Ah	20986	\$680.00
SE101XAT, SE101XIT, SE101XJT	12 Volt / 9.0 Ah	20986	\$680.00
SE122XAT, SE122XIT, SE122XJT	12 Volt / 8.5 Ah	40390	\$33.00
SE162XAT, SE162XIT, SE162XJT	12 Volt / 9.0 Ah	40986	\$1,360.00
SE202XAT, SE202XIT, SE202XJT	12 Volt / 9.0 Ah	40986	\$1,360.00

**ONEAC (CHLORIDE) ... continued from previous page**

SEBP610-2	12 Volt / 8.5 Ah	40390	\$33.00
-----------	------------------	-------	---------

**OPTI-UPS**

AS1000B-S, AS1000C-S	12 Volt / 8.5 Ah	2390	\$66.00
AS1500B-S, AS1500C-S, AS2000B-S, AS2000C-S	12 Volt / 9.0 Ah	2986	\$68.00
AS450B-S, AS450C-S	12 Volt / 5.5 Ah	1388	\$33.00
AS650B-S, AS650C-S	12 Volt / 8.5 Ah	1390	\$33.00
AS850B-S, AS850C-S	12 Volt / 9.0 Ah	1986	\$34.00
CS385B	6 Volt / 4.5 Ah	1374	\$14.00
CS500B	12 Volt / 3.4 Ah	1384	\$25.00
CS530B, CS730B	6 Volt / 4.5 Ah	2374	\$28.00
DS10000B, DS10KB31, DS10KB31	12 Volt / 9.0 Ah	20986	\$680.00
DS10000E, DS8KBT	12 Volt / 7.0 Ah	20390	\$660.00
DS1000B, DS1000B-RM, DS1000E-RM(E)/(C), DS1000E	12 Volt / 8.5 Ah	3390	\$99.00
DS10KB-RM, DS10KB-RMP	12 Volt / 7.0 Ah	20390	\$660.00
DS10KBT, DS10KB31T	12 Volt / 9.0 Ah	20986	\$680.00
DS12000B, DS12KB31, DS15000B	12 Volt / 8.5 Ah	40390	\$33.00
DS12KB31, DS15KB31T, DS15KBT	12 Volt / 8.5 Ah	40390	\$33.00
DS12KB31T, DS12KBT	12 Volt / 8.5 Ah	40390	\$33.00
DS1500B, DS1500B-RM	12 Volt / 8.5 Ah	3390	\$99.00
DS20000B, DS20KB31, DS20KB31T, DS20KBT	12 Volt / 9.0 Ah	40986	\$1,360.00
DS2000B, DS2000B-RM, DS3000B-RM	12 Volt / 8.5 Ah	6390	\$198.00
DS2000E	12 Volt / 8.5 Ah	8390	\$265.00
DS2000E, DS3000B	12 Volt / 8.5 Ah	6390	\$198.00
DS3000E	12 Volt / 8.5 Ah	6390	\$198.00
DS6000B, DS6000E, DS6KB-RM, DS6KB-RMP	12 Volt / 7.0 Ah	20390	\$660.00
DS6KBT, DS8000B, DS8KB31, DS8KB31T	12 Volt / 7.0 Ah	20390	\$660.00
EL3000-AL, EL5000-AL (Requires 16/unit)	12 Volt / 100 Ah	5987	\$215.00
ES1000C, ES1000C-RM, ES1500C, ES1500C-RM	12 Volt / 8.5 Ah	2390	\$66.00
ES550C, ES800C	12 Volt / 8.5 Ah	1390	\$33.00
FS600, FS600B	12 Volt / 5.5 Ah	1388	\$33.00
GS1100B	12 Volt / 8.5 Ah	1390	\$33.00
IS1000B	12 Volt / 8.5 Ah	2390	\$66.00
IS1500B, IS2000B	12 Volt / 9.0 Ah	2986	\$68.00
IS650B	12 Volt / 8.5 Ah	1390	\$33.00
IS850B	12 Volt / 9.0 Ah	1986	\$34.00
OD330	12 Volt / 100 Ah	5987	\$215.00
OD330-AL, OD500, OD1000 (Requires 2/unit)	12 Volt / 100 Ah	5987	\$215.00
PS10000D-RT	12 Volt / 9.0 Ah	16986	\$544.00
PS1000B, PS1000C, PS1000D, PS1000D-RM, PS1000D-RT	12 Volt / 8.5 Ah	2390	\$66.00
PS1250C, PS1500C, PS2000C	12 Volt / 8.5 Ah	2390	\$66.00
PS1500B, PS1500D, PS1000B-RM, PS1500B-RM, PS1500D-RT	12 Volt / 8.5 Ah	3390	\$99.00
PS1500D-RM	12 Volt / 9.0 Ah	2986	\$68.00
PS2000D, PS2000D-RT	12 Volt / 9.0 Ah	3986	\$102.00
PS2200B, PS3000B	12 Volt / 8.5 Ah	8390	\$265.00
PS2200B-RM, PS3000B-RM	12 Volt / 5.5 Ah	8388	\$264.00
PS3000C	12 Volt / 8.5 Ah	4390	\$132.00
PS3000D-RT	12 Volt / 8.5 Ah	6390	\$198.00
PS5000D-RT	12 Volt / 9.0 Ah	8986	\$272.00
PS500C, PS700C	12 Volt / 8.5 Ah	1390	\$33.00
PS650D	12 Volt / 9.0 Ah	1986	\$34.00
PS7500D-RT	12 Volt / 8.5 Ah	16390	\$530.00
PS800B	12 Volt / 5.5 Ah	2388	\$66.00
RS650B	12 Volt / 8.5 Ah	1390	\$33.00

<b>OPTI-UPS ... continued from previous page</b>			
TS1250, TS1250B, TS1250W	12 Volt / 8.5 Ah	2390	\$66.00
TS1700, TS1700B, TS2250, TS2250B	12 Volt / 8.5 Ah	2390	\$66.00
TS400, TS500, TS500B, TS650, TS650B	12 Volt / 5.5 Ah	1388	\$33.00
TS600D, TS650W, TS1000, TS1000B	12 Volt / 8.5 Ah	1390	\$33.00
TS800D	12 Volt / 9.0 Ah	1986	\$34.00
VS375C, VS400C, VS575C, VS600C	12 Volt / 3.4 Ah	1384	\$25.00
VS450, VS450B, VS450C	12 Volt / 5.5 Ah	1388	\$33.00
VS650, VS650B, VS650C	12 Volt / 8.5 Ah	1390	\$33.00
VS850, VS850B, VS850C	12 Volt / 9.0 Ah	1986	\$34.00

<b>PK ELECTRONICS</b>			
Blackout Buster 400	6 Volt / 4.5 Ah	1374	\$14.00
Blackout Buster 700, 1000, 1400, 1600, 2000	12 Volt / 8.5 Ah	1390	\$33.00
Blackout Buster B6U, TX600	12 Volt / 8.5 Ah	1390	\$33.00
Blackout Buster TX1000	12 Volt / 9.0 Ah	1986	\$34.00
US8000R, US8010, US8020, US8030	12 Volt / 8.5 Ah	1390	\$33.00
US9001, US9003, USB120T8EX	12 Volt / 8.5 Ah	1390	\$33.00

<b>POWERCOM</b>			
BNT-500AP, 600AP, 800AP, 1000AP, 1500AP	12 Volt / 8.5 Ah	1390	\$33.00
CTV-1000, CTV-1500	12 Volt / 24.0 Ah	1393	\$70.00
EBK-500S	6 Volt / 4.5 Ah	1374	\$14.00
IMP-625U, IMD-1025U	12 Volt / 8.5 Ah	1390	\$33.00
KIN-425CSU, KIN-625CS, KIN-1000AP, KIN-1500APRM, KIN-2200APRM	12 Volt / 8.5 Ah	1390	\$33.00
KOF-575S	12 Volt / 5.4 Ah	1984	\$36.00
SMK-600A-RM, SMK-1000A-RM, SMK-1500A-RM, SMK-2000A-RM	12 Volt / 8.5 Ah	1390	\$33.00
SMK-600A, SMK-1000A, SMK-1500A, SMK-2000A	12 Volt / 8.5 Ah	1390	\$33.00

<b>POWER KINETICS</b>			
BB148E, BB20E	12 Volt / 9.0 Ah	2986	\$68.00
CE, CSA, UL	12 Volt / 7.0 Ah	10390	\$330.00
PR1	12 Volt / 8.5 Ah	4390	\$132.00
TX1000	12 Volt / 9.0 Ah	1986	\$34.00
TX600, US9003PA104E	12 Volt / 8.5 Ah	1390	\$33.00
US9001PA310E	12 Volt / 8.5 Ah	3390	\$99.00

<b>POWERVAR</b>			
<b>POWERVAR - ACE</b>			
ACE1000a, ACE1000a-RM, ACE1000i, ACE1000i-RM	12 Volt / 9.0 Ah	2986	\$68.00
ACE1500	12 Volt / 8.5 Ah	3390	\$99.00
ACE2000	12 Volt / 8.5 Ah	4390	\$132.00
ACE600, ACE600i, ACE1000	12 Volt / 8.5 Ah	2390	\$66.00
<b>POWERVAR - ACE PLUS</b>			
ACDEF1500R	12 Volt / 8.5 Ah	4390	\$132.00
ACDEF1500T, ACDEF2000T	12 Volt / 8.5 Ah	6390	\$198.00
ACDEF2200R	12 Volt / 9.0 Ah	4986	\$136.00
ACDEF3000T, ACDEF3000R, ACDEF3000T-208	12 Volt / 9.0 Ah	6986	\$204.00
ACEDF1000T, ACDEF1000R	12 Volt / 8.5 Ah	3390	\$99.00
<b>POWERVAR - SECURITY ONE GROUND GUARD UPM</b>			

<b>POWERVAR ... continued from previous page</b>			
<b>POWERVAR - SECURITY ONE GROUND GUARD UPM ... continued from previous page</b>			
ABCEG1100-11, ABCEG1100-22	12 Volt / 12.0 Ah	2551	\$90.00
ABCEG1440-11, ABCEG1440-22	12 Volt / 8.5 Ah	4390	\$132.00
ABCEG240-11, ABCEG240-22, ABCEG350-11, ABCEG350-22	12 Volt / 5.5 Ah	2388	\$66.00
ABCEG420-11, ABCEG420-22, ABCEG500-11, ABCEG500-22	12 Volt / 5.5 Ah	2388	\$66.00
ABCEG600-11, ABCEG600-22, ABCEG800-11, ABCEG800-22	12 Volt / 8.5 Ah	2390	\$66.00
<b>POWERVAR - SECURITY ONE MEDICAL UPM</b>			
ABCE1100-11IEC, ABCE1100-22IEC	12 Volt / 12.0 Ah	2551	\$90.00
ABCE1440-11IEC, ABCE1440-22IEC	12 Volt / 8.5 Ah	4390	\$132.00
ABCE350-11IEC, ABCE350-22IEC	12 Volt / 5.5 Ah	2388	\$66.00
ABCE420-11IEC, ABCE420-22IEC, ABCE500-11IEC, ABCE500-22IEC	12 Volt / 5.5 Ah	2388	\$66.00
ABCE600-11IEC, ABCE600-22IEC, ABCE800-11IEC, ABCE800-22IEC	12 Volt / 8.5 Ah	2390	\$66.00
<b>POWERVAR - SECURITY ONE RACKMOUNT MEDICAL UPM</b>			
ABCE1100-11IECR, ABCE1100-22IECR	12 Volt / 12.0 Ah	2551	\$90.00
ABCE1440-11IECR, ABCE1440-22IECR	12 Volt / 8.5 Ah	4390	\$132.00
ABCE600-11IECR, ABCE600-22IECR, ABCE800-11IECR, ABCE800-22IECR	12 Volt / 8.5 Ah	2390	\$66.00
<b>POWERVAR - SECURITY ONE RACKMOUNT UPM</b>			
ABCE1100-11R	12 Volt / 12.0 Ah	2551	\$90.00
ABCE1100-22R	12 Volt / 12.0 Ah	2551	\$90.00
ABCE1440-11R, ABCE1440-22R	12 Volt / 8.5 Ah	4390	\$132.00
ABCE600-11R, ABCE600-22R, ABCE800-11R, ABCE800-22R	12 Volt / 8.5 Ah	2390	\$66.00
<b>POWERVAR - SECURITY ONE UPM</b>			
ABCE1100-11, ABCE1100-22	12 Volt / 12.0 Ah	2551	\$90.00
ABCE1440-11, ABCE1440-22	12 Volt / 8.5 Ah	4390	\$132.00
ABCE2200-11, ABCE2200-22, ABCE3000-11, ABCE3000-22	12 Volt / 8.5 Ah	8390	\$265.00
ABCE240-11, ABCE240-22, ABCE350-11, ABCE350-22	12 Volt / 5.5 Ah	2388	\$66.00
ABCE420-11, ABCE420-22, ABCE500-11, ABCE500-22	12 Volt / 5.5 Ah	2388	\$66.00
ABCE600-11, ABCE600-22, ABCE800-11, ABCE800-22	12 Volt / 8.5 Ah	2390	\$66.00
<b>POWERVAR - SECURITY PLUS</b>			
ABCDEF2000-11, ABCDEF2000-22	12 Volt / 8.5 Ah	8390	\$265.00
ABCDEF3000-11, ABCDEF3000-22	12 Volt / 8.5 Ah	16390	\$530.00
ABCDEF4000-22, ABCDEF5200-22, ABCDEF6000-22	12 Volt / 8.5 Ah	16390	\$530.00
ABCDEF8000-22, ABCDEF10.0-22	12 Volt / 8.5 Ah	24390	\$792.00

<b>SL WABER</b>			
POWERHOUSE 250, POWERHOUSE 280	12 Volt / 5.5 Ah	1388	\$33.00
POWERHOUSE 420, POWERHOUSE 550	6 Volt / 4.5 Ah	2374	\$28.00
POWERHOUSE 500, POWERHOUSE 650, UPSTART 550	12 Volt / 5.5 Ah	2388	\$66.00
UPSTART 350	12 Volt / 8.5 Ah	1390	\$33.00

<b>SOLAHD</b>			
30-250, 30-250A, 30-250B, 30-250E, 30-250F, 30-250S	6 Volt / 4.5 Ah	2374	\$28.00
30-400, 30-400A, 30-400B, 30-400E, 30-400F, 30-400S	12 Volt / 8.5 Ah	1390	\$33.00
310-1000-A, 310-1000-E	12 Volt / 12.0 Ah	3551	\$135.00
310-300-A, 310-300-E, 310-400-A, 310-400-E	12 Volt / 8.5 Ah	1390	\$33.00
310-750-A, 310-750-E	12 Volt / 8.5 Ah	2390	\$66.00
510-1250-A, 510-1250-E, 510-1250-U	12 Volt / 9.0 Ah	4986	\$136.00
510-1650-A, 510-1650-E, 510-1650-U	12 Volt / 18.0 Ah	4391	\$260.00



**SOLAHD ... continued from previous page**

510-2000-A, 510-2000-E, 510-2000-U	12 Volt / 18.0 Ah	4391	\$260.00
510-600-A, 510-600-E, 510-600-U	12 Volt / 9.0 Ah	2986	\$68.00
510-900-A, 510-900-E, 510-900-U	12 Volt / 9.0 Ah	4986	\$136.00
S2350, S2470	12 Volt / 8.5 Ah	1390	\$33.00
S2700	12 Volt / 12.0 Ah	1551	\$45.00
S2K1000, S2K1000-5	12 Volt / 8.5 Ah	2390	\$66.00
S2K350, S2K350-5	12 Volt / 8.5 Ah	1390	\$33.00
S2K500, S2K500-5, S2K650, S2K650-5	12 Volt / 9.0 Ah	1986	\$34.00
S31000, S31000-5, S31000R, S31000R-5	12 Volt / 8.5 Ah	3390	\$99.00
S31400, S31400-5, S31400R, S31400R-5	12 Volt / 8.5 Ah	4390	\$132.00
S32200, S2200-5, S32200R, S32200R-5	6 Volt / 13.5 Ah	8614	\$160.00
S3700, S3700-5, S3700R, S3700R-5	12 Volt / 8.5 Ah	2390	\$66.00
S3K2U1000, S3K2U1000-5, S3K2U1440, S3K2U1440-5	12 Volt / 8.5 Ah	4390	\$132.00
S3K2U2200, S3K2U2200-5	12 Volt / 8.5 Ah	6390	\$198.00
S3K2U3000, S3K2U3000-5	12 Volt / 9.0 Ah	6986	\$204.00
S410000, S410000-208, S410000-240	12 Volt / 8.5 Ah	40390	\$33.00
S41000-5, S41000TRM-5	12 Volt / 8.5 Ah	3390	\$99.00
S41000, S41000TRM	12 Volt / 8.5 Ah	3390	\$99.00
S41500TRM, S41500TRM-5	12 Volt / 8.5 Ah	4390	\$132.00
S41800-208TRM, S42000TRM, S42700-208TRM, S43000TRM	12 Volt / 8.5 Ah	8390	\$265.00
S42000TRM-5, S43000TRM-5	12 Volt / 8.5 Ah	8390	\$265.00
S46000, S46000-208, S46000-240	12 Volt / 7.0 Ah	20390	\$660.00
S4700, S4700-5	12 Volt / 8.5 Ah	2390	\$66.00
S4K2U1500C	12 Volt / 8.5 Ah	4390	\$132.00
S4K2U2000-5, S4K2U2000-5C	12 Volt / 9.0 Ah	4986	\$136.00
S4K2U2000, S4K2U2000C	12 Volt / 9.0 Ah	4986	\$136.00
S4K2U3000, S4K2U3000C, S4K2U3000-5, S4K2U3000-5C	12 Volt / 9.0 Ah	6986	\$204.00
S4K2U700C, S4K2U1000C, S4K2U1000-5C	12 Volt / 5.5 Ah	4388	\$132.00
S4K2U700, S4K2U1000, S4K2U1000-5, S4K2U1500	12 Volt / 9.0 Ah	4986	\$136.00
S4K4U6000	12 Volt / 9.0 Ah	12986	\$408.00
S4K5U4500-5, S4K5U6000-5	12 Volt / 5.0 Ah	20388	\$660.00
SDU500, SDU500-5, SDU850, SDU850-5	12 Volt / 8.5 Ah	1390	\$33.00

**TOSHIBA**

UC0A1A005C6T	12 Volt / 8.5 Ah	3390	\$99.00
UC0A1A007C6T	12 Volt / 8.5 Ah	4390	\$132.00
UC0A1A010C6T	12 Volt / 7.0 Ah	55390	\$165.00
UC0A1A015C6T	12 Volt / 8.5 Ah	6390	\$198.00
UC1A1A006C6B	12 Volt / 8.5 Ah	3390	\$99.00
UC1A1A006C6T	12 Volt / 8.5 Ah	3390	\$99.00
UC1A1A006C6TB	12 Volt / 8.5 Ah	3390	\$99.00
UC1A1A008C6	12 Volt / 8.5 Ah	4390	\$132.00
UC1A1A008C6B	12 Volt / 8.5 Ah	4390	\$132.00
UC1A1A008C6T	12 Volt / 8.5 Ah	4390	\$132.00
UC1A1A008C6TB	12 Volt / 8.5 Ah	4390	\$132.00
UC1A1A010C6	12 Volt / 8.5 Ah	4390	\$132.00
UC1A1A010C6B	12 Volt / 8.5 Ah	4390	\$132.00
UC1A1A010C6T	12 Volt / 8.5 Ah	4390	\$132.00
UC1A1A010C6TB	12 Volt / 8.5 Ah	4390	\$132.00
UC1A1A012C6	12 Volt / 7.0 Ah	55390	\$165.00
UC1A1A012C6B	12 Volt / 7.0 Ah	55390	\$165.00
UC1A1A015C6	12 Volt / 8.5 Ah	6390	\$198.00
UC1A1A015C6B	12 Volt / 8.5 Ah	6390	\$198.00
UC1A1A015C6RK	12 Volt / 8.5 Ah	6390	\$198.00

**TOSHIBA ... continued from previous page**

UC1A1A015C6RKB	12 Volt / 8.5 Ah	6390	\$198.00
UC1A1A015C6T	12 Volt / 8.5 Ah	6390	\$198.00
UC1A1A015C6TB	12 Volt / 8.5 Ah	6390	\$198.00
UC1A1A020C6	12 Volt / 8.5 Ah	8390	\$265.00
UC1A1A020C6B	12 Volt / 8.5 Ah	8390	\$265.00
UC1A1A020C6RKB	12 Volt / 8.5 Ah	6390	\$198.00
UC1A1A024C6B	12 Volt / 8.5 Ah	8390	\$265.00
UC1A1A024C6TB	12 Volt / 8.5 Ah	8390	\$265.00
UC1E1E010-5AU	12 Volt / 8.5 Ah	4390	\$132.00
UC1E1E015-5AR	12 Volt / 8.5 Ah	6390	\$198.00
UC1E1E015-5AU	12 Volt / 8.5 Ah	6390	\$198.00
UC1E1E015-5M1	12 Volt / 8.5 Ah	6390	\$198.00
UC1E1E020-5AU	12 Volt / 8.5 Ah	8390	\$265.00
UC1E1E020-5M1	12 Volt / 8.5 Ah	8390	\$265.00
UC1E1E020C5TB	12 Volt / 8.5 Ah	8390	\$265.00
UC1E1E024-5AU	12 Volt / 8.5 Ah	8390	\$265.00
UC1G2L024C6TB	12 Volt / 8.5 Ah	8390	\$265.00
UC3A2L024C6	12 Volt / 8.5 Ah	8390	\$265.00
UC3E1E024C5	12 Volt / 8.5 Ah	8390	\$265.00
UC3E1E036-51	12 Volt / 8.5 Ah	12390	\$396.00
UC3E1E060-51	12 Volt / 8.5 Ah	18390	\$594.00
UC3E1E080-51	12 Volt / 8.5 Ah	21390	\$693.00
UC3E1E100C5(1)	12 Volt / 8.5 Ah	30390	\$990.00
UC3E1E120C5(1)	12 Volt / 8.5 Ah	36390	\$1,188.00
UC3E1E180C5(1)	12 Volt / 8.5 Ah	54390	\$1,782.00
UC3G2L024C6	12 Volt / 8.5 Ah	8390	\$265.00
UC3G2L036C6	12 Volt / 8.5 Ah	12390	\$396.00
UC3G2L060C6	12 Volt / 8.5 Ah	18390	\$594.00
UC3G2L080C6	12 Volt / 8.5 Ah	21390	\$693.00
UC3G2L100C6(1)	12 Volt / 8.5 Ah	30390	\$990.00
UC3G2L120C6(1)	12 Volt / 8.5 Ah	36390	\$1,188.00
UC3G2L180C6(1)	12 Volt / 8.5 Ah	54390	\$1,782.00
UCA1A1006C6	12 Volt / 8.5 Ah	3390	\$99.00
UE1A1A006C6	12 Volt / 5.5 Ah	55388	\$165.00
UE1A1A006C6T	12 Volt / 5.5 Ah	55388	\$165.00
UE1A1A008C6	12 Volt / 5.5 Ah	55388	\$165.00
UE1A1A008C6T	12 Volt / 5.5 Ah	55388	\$165.00
UE1A1A010C6	12 Volt / 5.5 Ah	55388	\$165.00
UE1A1A010C6T	12 Volt / 5.5 Ah	55388	\$165.00
UE1A1A012C6	12 Volt / 5.5 Ah	55388	\$165.00
UE1E1E006-5M	12 Volt / 5.5 Ah	55388	\$165.00
UE1E1E008-5M	12 Volt / 5.5 Ah	55388	\$165.00
UE1E1E010-5M	12 Volt / 5.5 Ah	55388	\$165.00
UE3G2L036C61T	12 Volt / 8.5 Ah	3390	\$99.00
UE3G2L036C61TC3	12 Volt / 8.5 Ah	2390	\$66.00
UE3G2L060C61T	12 Volt / 8.5 Ah	3390	\$99.00
UE3G2L080C61T	12 Volt / 8.5 Ah	4390	\$132.00
UE3G2L100C61T	12 Volt / 8.5 Ah	4390	\$132.00
UE3G2L140C61T	12 Volt / 8.5 Ah	8390	\$265.00
UE3G2L180C61T	12 Volt / 8.5 Ah	8390	\$265.00
UE3G2L220C61T	12 Volt / 8.5 Ah	8390	\$265.00
UH3G2L036C61T	12 Volt / 8.5 Ah	2390	\$66.00
UH3G2L060C61T	12 Volt / 8.5 Ah	3390	\$99.00
UH3G2L080C61T	12 Volt / 8.5 Ah	4390	\$132.00

<b>TOSHIBA ... continued from previous page</b>			
UH3G2L100C61T	12 Volt / 8.5 Ah	4390	\$132.00
UH3G2L140C61T	12 Volt / 8.5 Ah	8390	\$265.00
UH3G2L180C61T	12 Volt / 8.5 Ah	8390	\$265.00
UH3G2L220C61T	12 Volt / 8.5 Ah	8390	\$265.00
UT1A1A010C6	12 Volt / 9.0 Ah	3986	\$102.00
UT1A1A010C6RKB2	12 Volt / 9.0 Ah	3986	\$102.00
UT1A1A015C6	12 Volt / 9.0 Ah	3986	\$102.00
UT1A1A015C6RKB2	12 Volt / 9.0 Ah	3986	\$102.00
UT1A1A020C6	12 Volt / 8.5 Ah	6390	\$198.00
UT1A1A020C6RKB2	12 Volt / 8.5 Ah	6390	\$198.00
UT1A1A030C6	12 Volt / 8.5 Ah	6390	\$198.00
UT1A1A030C6RKB2	12 Volt / 8.5 Ah	6390	\$198.00
UT1E1E010C6	12 Volt / 9.0 Ah	3986	\$102.00
UT1E1E010C6RKB2	12 Volt / 9.0 Ah	3986	\$102.00
UT1E1E015C6	12 Volt / 9.0 Ah	3986	\$102.00
UT1E1E015C6RKB2	12 Volt / 9.0 Ah	3986	\$102.00
UT1E1E020C6	12 Volt / 8.5 Ah	6390	\$198.00
UT1E1E020C6RKB2	12 Volt / 8.5 Ah	6390	\$198.00
UT1E1E030C6	12 Volt / 8.5 Ah	6390	\$198.00
UT1E1E030C6RKB2	12 Volt / 8.5 Ah	6390	\$198.00

<b>TRIPP LITE</b>			
<b>POWER BACK UP SYSTEMS</b>			
AVR550U	TrippLite AVR550U UPS	AVR550U	\$99.00
AVR750U	TrippLite AVR750U UPS	AVR750U	\$129.00
BCPERS450	TrippLite BCPERS450 UPS	BCPERS450	\$125.00
BCPRO1050	TrippLite BC PRO 1050 UPS	BCPRO1050	\$372.00
BCPRO1400	TrippLite BC PRO 1400 UPS	BCPRO1400	\$575.00
INTERNET350U	TrippLite Internet Office 350 UPS	INTERNET350U	\$65.00
INTERNET550U	TrippLite Internet Office 550 UPS	INTERNET550U	\$85.00
INTERNET750U	TrippLite Internet Office 750 UPS	INTERNET750U	\$124.00
INTERNET900U	TrippLite Internet Office 900 UPS	INTERNET900U	\$145.00
OMNI650LCD	TrippLite OmniSmart 650LCD UPS	OMNI650LCD	\$160.00
OMNI900LCD	TrippLite OmniSmart 900LCD UPS	OMNI900LCD	\$179.00
OMNIVS1000	TrippLite Omni VS 1000 UPS	OMNIVS1000	\$192.00
OMNIVS1500XL	TrippLite Omni VS 1500XL UPS	OMNIVS1500XL	\$318.00
OMNIVS500U	TrippLite Omni VS 500 UPS	OMNIVS500U	\$89.00
SMART1000LCD	TrippLite Smart 1000VA LCD UPS	SMART1000LCD	\$202.00

UPS

<b>TRIPP LITE ... continued from previous page</b>			
<b>POWER BACK UP SYSTEMS ... continued from previous page</b>			
SMART1200LCD	TrippLite Smart 1200VA LCD UPS	SMART1200LCD	\$274.00
<b>TRIPP LITE - AVR SERIES</b>			
AVR750U, AVRX750U, AVRX750UD, AVRX750UK, AVRX750UF, AVRX750UI, AVR900U	12 Volt / 8.5 Ah	1390	\$33.00
<b>TRIPP LITE - BC SERIES</b>			
BCPERS450, BCPRO600	12 Volt / 8.5 Ah	1390	\$33.00
BCPRO1400	12 Volt / 8.5 Ah	3390	\$99.00
BCPRO850, BCPRO1050	6 Volt / 13.5 Ah	3380	\$60.00
<b>TRIPP LITE - HOME THEATER SERIES</b>			
HT850UPS	12 Volt / 8.5 Ah	1390	\$33.00
<b>TRIPP LITE - INTERNET SERIES</b>			
INTERNET500I	12 Volt / 8.5 Ah	1390	\$33.00
INTERNET700I	6 Volt / 13.5 Ah	2380	\$40.00
INTERNETOFFICE500	12 Volt / 8.5 Ah	1390	\$33.00
INTERNETOFFICE700	12 Volt / 8.5 Ah	1390	\$33.00
<b>TRIPP LITE - LCD SERIES</b>			
SMART1000LCD	12 Volt / 8.5 Ah	1390	\$33.00
SMART1200LCD	12 Volt / 8.5 Ah	4390	\$132.00
<b>TRIPP LITE - OMNI SERIES</b>			
OMNI1000ISO	12 Volt / 8.5 Ah	3390	\$99.00
OMNI1500ISO	12 Volt / 8.5 Ah	1390	\$33.00
OMNI1650LCD	12 Volt / 8.5 Ah	1390	\$33.00
OMNI1750ISO	12 Volt / 8.5 Ah	3390	\$99.00
OMNI1900LCD	12 Volt / 8.5 Ah	1390	\$33.00
OMNISMART1050	6 Volt / 13.5 Ah	2380	\$40.00
OMNISMART1400HG	12 Volt / 8.5 Ah	3390	\$99.00
OMNISMART300PNP	12 Volt / 8.5 Ah	1390	\$33.00
OMNISMART350HG	6 Volt / 13.5 Ah	2380	\$40.00
OMNISMART450HG	12 Volt / 8.5 Ah	1390	\$33.00
OMNISMART500	12 Volt / 8.5 Ah	1390	\$33.00
OMNISMART700	12 Volt / 8.5 Ah	1390	\$33.00
OMNIVS1000	12 Volt / 8.5 Ah	1390	\$33.00
OMNIVS1500	12 Volt / 8.5 Ah	2390	\$66.00
OMNIVS1500XL	12 Volt / 8.5 Ah	2390	\$66.00
OMNIVS800	12 Volt / 8.5 Ah	1390	\$33.00
OMNIVSINT1000	12 Volt / 8.5 Ah	1390	\$33.00
OMNIVSINT1500XL	12 Volt / 8.5 Ah	2390	\$66.00
OMNIVSINT800	12 Volt / 8.5 Ah	1390	\$33.00
OMNIX350HG	6 Volt / 13.5 Ah	2380	\$40.00
<b>TRIPP LITE PART NUMBER CROSS REFERENCE</b>			
RBC11A	48 Volt / 18.0 Ah	4391-A	\$260.00
RBC12A	96 Volt / 8.5 Ah	8390-A	\$265.00
RBC24-SLT	24 Volt / 8.5 Ah	2390-A	\$66.00
RBC24-SUTWR	12 Volt / 8.5 Ah	2390	\$66.00
RBC2A	12 Volt / 8.5 Ah	1390	\$33.00
RBC36-SLT	12 Volt / 9.0 Ah	3986	\$102.00
RBC49-2U	12 Volt / 9.0 Ah	4986	\$136.00
RBC4A	12 Volt / 12.0 Ah	1551	\$45.00
RBC51	12 Volt / 8.5 Ah	1390	\$33.00
RBC5-192	12 Volt / 5.5 Ah	16388	\$528.00

<b>TRIPP LITE ... continued from previous page</b>			
<b>TRIPP LITE PART NUMBER CROSS REFERENCE ... continued from previous page</b>			
RBC52	6 Volt / 13.5 Ah	1380	\$20.00
RBC53	12 Volt / 8.5 Ah	3390	\$99.00
RBC54	12 Volt / 8.5 Ah	4390	\$132.00
RBC58-2U	12 Volt / 5.5 Ah	8388	\$264.00
RBC5A	24 Volt / 8.5 Ah	2390-A	\$66.00
RBC62-1U (Complete with connector)	12 Volt / 7.0 Ah	2375-AP	\$65.00
RBC64-1U	6 Volt / 7.0 Ah	4375	\$56.00
RBC69-1U	6 Volt / 9.0 Ah	4376	\$85.00
RBC6A	24 Volt / 12.0 Ah	2551-A	\$90.00
RBC7A (Complete with fuse & connector)	24 Volt / 18.0 Ah	2391-AP	\$175.00
RBC8A	48 Volt / 8.5 Ah	4390-A	\$132.00
RBC9-192	12 Volt / 8.5 Ah	16390	\$530.00
RBC92-2U	12 Volt / 8.5 Ah	2390	\$66.00
RBC93-2U	12 Volt / 8.5 Ah	3390	\$99.00
RBC94-2U	12 Volt / 8.5 Ah	4390	\$132.00
RBC94-3U	12 Volt / 8.5 Ah	4390	\$132.00
RBC96-2U	12 Volt / 8.5 Ah	6390	\$198.00
RBC96-3U	12 Volt / 8.5 Ah	6390	\$198.00
<b>TRIPP LITE - PRO SERIES</b>			
POS500	12 Volt / 8.5 Ah	1390	\$33.00
<b>TRIPP LITE - SMART INT SERIES</b>			
SMARTINT1500	12 Volt / 8.5 Ah	3390	\$99.00
SMARTINT2200VS, SMARTINT3000VS	12 Volt / 8.5 Ah	4390	\$132.00
SMARTINT700	6 Volt / 13.5 Ah	1380	\$20.00
<b>TRIPP LITE - SMART SERIES</b>			
SMART1000RM2U	12 Volt / 8.5 Ah	2390	\$66.00
SMART1050	6 Volt / 13.5 Ah	1380	\$20.00
SMART1050SLT	24 Volt / 8.5 Ah	2390-A	\$66.00
SMART1200XLHG	12 Volt / 8.5 Ah	3390	\$99.00
SMART1500	12 Volt / 8.5 Ah	3390	\$99.00
SMART1500CRMXL	12 Volt / 8.5 Ah	4390	\$132.00
SMART1500RM2U	12 Volt / 8.5 Ah	3390	\$99.00
SMART1500RMXL2UA	12 Volt / 8.5 Ah	3390	\$99.00
SMART1500SLT	12 Volt / 9.0 Ah	3986	\$102.00
SMART1500XL	12 Volt / 8.5 Ah	3390	\$99.00
SMART2200CRMXL	12 Volt / 8.5 Ah	4390	\$132.00
SMART2200RM2U	12 Volt / 8.5 Ah	4390	\$132.00
SMART2200RMXL2U	12 Volt / 8.5 Ah	4390	\$132.00
SMART2200RMXL2UP	12 Volt / 8.5 Ah	4390	\$132.00
SMART2200SLT	12 Volt / 8.5 Ah	4390	\$132.00
SMART2200VS	12 Volt / 8.5 Ah	4390	\$132.00
SMART2200VSXL	12 Volt / 8.5 Ah	4390	\$132.00
SMART2600RM2U	12 Volt / 8.5 Ah	4390	\$132.00
SMART3000CRMXL	12 Volt / 8.5 Ah	4390	\$132.00
SMART3000RM2U	12 Volt / 8.5 Ah	4390	\$132.00
SMART3000RMXL2U	12 Volt / 5.5 Ah	8388	\$264.00
SMART3000SLT	12 Volt / 8.5 Ah	4390	\$132.00
SMART3000VS	12 Volt / 8.5 Ah	4390	\$132.00
SMART5000TEL3U	12 Volt / 8.5 Ah	4390	\$132.00
SMART5000XFMRXL	12 Volt / 8.5 Ah	4390	\$132.00
SMART500RT1U	12 Volt / 7.0 Ah	2375-AP	\$65.00
SMART700DV	12 Volt / 8.5 Ah	4390	\$132.00

UPS

<b>TRIPP LITE ... continued from previous page</b>			
<b>TRIPP LITE - SMART SERIES ... continued from previous page</b>			
SMART700DVA	12 Volt / 8.5 Ah	1390	\$33.00
SMART700HG	12 Volt / 8.5 Ah	3390	\$99.00
SMART700SER, SMART750	6 Volt / 13.5 Ah	1380	\$20.00
SMART750RMXL2U	12 Volt / 8.5 Ah	2390	\$66.00
SMART750SLT	12 Volt / 8.5 Ah	1390	\$33.00
SMART750XLA	24 Volt / 8.5 Ah	2390-A	\$66.00
<b>TRIPP LITE - SMX SERIES</b>			
SMX1000RT2U	12 Volt / 8.5 Ah	2390	\$66.00
SMX1050SLT	24 Volt / 8.5 Ah	2390-A	\$66.00
SMX1250XLHG	12 Volt / 8.5 Ah	3390	\$99.00
SMX1500SLT	12 Volt / 9.0 Ah	3986	\$102.00
SMX1500XLRT2U	12 Volt / 8.5 Ah	3390	\$99.00
SMX2200XLRT2U	12 Volt / 8.5 Ah	4390	\$132.00
SMX3000XLRT2U	12 Volt / 8.5 Ah	4390	\$132.00
SMX5000XLRT3U	12 Volt / 8.5 Ah	6390	\$198.00
SMX500RT1U (Complete with connector)	12 Volt / 7.0 Ah	2375-AP	\$65.00
SMX700HG	12 Volt / 8.5 Ah	3390	\$99.00
SMX750SLT	12 Volt / 8.5 Ah	1390	\$33.00
<b>TRIPP LITE - SUINT SERIES</b>			
SUINT1000RTXL2UA	12 Volt / 8.5 Ah	2390	\$66.00
SUINT1500RTXL2UA, SUINT2200RTXL2UA	12 Volt / 8.5 Ah	4390	\$132.00
SUINT3000RTXL2U, SUINT3000RTXL3U	12 Volt / 8.5 Ah	6390	\$198.00
<b>TRIPP LITE - SU SERIES</b>			
SU1000RTXL2UA	12 Volt / 8.5 Ah	2390	\$66.00
SU1000XLA	12 Volt / 8.5 Ah	2390	\$66.00
SU12KRT4UHW	12 Volt / 5.5 Ah	16388	\$528.00
SU1500RTXL2UA	12 Volt / 8.5 Ah	2390	\$66.00
SU2200RTXL2UA	12 Volt / 8.5 Ah	2390	\$66.00
SU3000RTXL2U	12 Volt / 8.5 Ah	6390	\$198.00
SU3000RTXL3U	12 Volt / 8.5 Ah	6390	\$198.00
SU3000RTXL3UHV	12 Volt / 8.5 Ah	6390	\$198.00
SU3000RTXR3U	12 Volt / 8.5 Ah	12390	\$396.00
SU3000RTXR3UJB	12 Volt / 8.5 Ah	12390	\$396.00
SU3000XL	12 Volt / 8.5 Ah	6390	\$198.00
SU5000RT4U	12 Volt / 8.5 Ah	16390	\$530.00
SU5000RT4UHV	12 Volt / 5.5 Ah	16388	\$528.00
SU5000RT4U-IMS	12 Volt / 8.5 Ah	16390	\$530.00
SU5000RT4UTF	12 Volt / 5.5 Ah	16388	\$528.00
SU6000RT4U	12 Volt / 8.5 Ah	16390	\$530.00
SU6000RT4UHV	12 Volt / 5.5 Ah	16388	\$528.00
SU6000RT4UHVVG	12 Volt / 5.5 Ah	16388	\$528.00
SU6000RT4UHVHW	12 Volt / 5.5 Ah	16388	\$528.00
SU6000RT4UTF	12 Volt / 5.5 Ah	16388	\$528.00
SU6000RT4UTFHW	12 Volt / 5.5 Ah	16388	\$528.00
SU750RTXL2U	12 Volt / 8.5 Ah	2390	\$66.00
SU750XL	12 Volt / 8.5 Ah	2390	\$66.00
SU8000RT4U	12 Volt / 8.5 Ah	16390	\$530.00
<b>TRIPP LITE - TE SERIES</b>			
TE1200	12 Volt / 8.5 Ah	3390	\$99.00
TE600	6 Volt / 13.5 Ah	2380	\$40.00
<b>TRIPP LITE - USB SERIES</b>			

**TRIPP LITE ... continued from previous page****TRIPP LITE - USB SERIES ... continued from previous page**

SMART55USB, SMART550USBWD, SMART750USB	12 Volt / 8.5 Ah	1390	\$33.00
--	------------------	------	---------

**UPSONIC**

750, DS800	12 Volt / 9.0 Ah	1986	\$34.00
CS1000, G1000, DS1000	12 Volt / 8.5 Ah	2390	\$66.00
CS1500, G1400, G2000	12 Volt / 9.0 Ah	2986	\$68.00
CS2000, CXR1000	12 Volt / 8.5 Ah	4390	\$132.00
CXR1500, S3000C	12 Volt / 9.0 Ah	4986	\$136.00
CXR2000, IRT3000	12 Volt / 8.5 Ah	8390	\$265.00
DS1400, DS2000	12 Volt / 9.0 Ah	2986	\$68.00
DS600	12 Volt / 8.5 Ah	1390	\$33.00
IP10000	12 Volt / 9.0 Ah	20986	\$680.00
IP6000	12 Volt / 7.0 Ah	20390	\$660.00
IRT1000, IS1000	12 Volt / 8.5 Ah	3390	\$99.00
IRT2000	12 Volt / 8.5 Ah	6390	\$198.00
IS2000	12 Volt / 9.0 Ah	6986	\$204.00
IS3000, CXR3000	12 Volt / 9.0 Ah	8986	\$272.00



**BENDIX / KING**

LPH, LPX, LAA0105, LAA0125	10.0 Volt / 1400 mAh	CB-109	\$37.00
LPH, LPX, LAA0105, LAA0125, LAA0197	10.0 Volt / 2500 mAh	CB-109MH	\$75.00

**EF JOHNSON**

5100 ES, 51SL ES, NTN8294	7.5 Volt / 1700 mAh	CB-8294	\$50.00
5100 ES, 51SL ES, NTN8923	7.5 Volt / 4000 mAh	CB-8923MHXT	\$45.00
IC-F3, IC-F4, IC-T2A, BP196	9.6 Volt / 1050 mAh	CB-196	\$40.00
IC-F3, IC-F4, IC-T2A, BP196H, BP179	9.6 Volt / 1650m Ah	CB-196NMH	\$40.00

**GE / ERICSSON**

KPC/LPE Prism, Panther 500P, BKB191202	7.5 Volt / 1700 mAh	CB-1202	\$67.00
KPC/LPE Prism, Panther 500P, BKB191203	7.5 Volt / 1200 mAh	CB-1203	\$67.00
Monogram 344A4506P1, MGPA5B	10.8 Volt / 700 mAh	CB-1155BLK	\$32.00
MP112WATT 19D900639G1, G2, G4	7.5 Volt / 600 mAh	CB-6391	\$25.00
MPA, MPD, PLS, TPX PAPA1H, 19A704850P1, 3, 5, 7 BKB191205/1	7.5 Volt / 1200 mAh	CB-8507	\$47.00
PAPA1H 19A704850P3, 5, 7, BKB191205/3	7.5 Volt / 1800 mAh	CB-8607	\$50.00

**ICOM**

BP-132H, BP-174, IC-2/4GXA/T, IC-W21A	9.6 Volt / 1100 mAh	CB-BP174H	\$39.00
F3, F4	9.6 Volt / 1050 mAh	CB-P196	\$33.00
F3, F4	9.6 Volt / 1650 mAh	CB-196MH	\$40.00
IC-F3GT/GS, IC-F21 & F21S	7.2 Volt / 1200 mAh	CB-209	\$45.00
IC-F3GT/GS, IC-F21 & F21S, BP210, BP222, ICF11	7.2 Volt / 1650 mAh	CB-210	\$48.00

**JTECH**

232020, 450, 46785, B11550, Commpass Voice, Commpass VTF, Glowsatt Plus, VTF, PAGSPVTFPB, Promopass, Serverpass	2.4 Volt / 400 mAh	PB-61	\$9.00
--	--------------------	-------	--------

**KENWOOD**

TH-G71, PB-38/38H	4.8 Volt / 700 mAh	CB-PB38	\$16.00
TK2140/3140/2160/3160, KNB24-LI (Li-Ion)	7.4 Volt / 1800 mAh	CB-5624LI	\$50.00
TK2140/3140, KNB25A	7.5 Volt / 1200 mAh	CB-5625	\$40.00
TK-2180,3180,5210	7.5 Volt / 1700 mAh	CB-KNB31A	\$46.00
TK250/350, KNB12A	7.5 Volt / 1200 mAh	CB-5612	\$38.00
TK250/350, KNB12A	7.5 Volt / 1800 mAh	CB-5612MH	\$44.00
TK260/360, KNB14A	7.5 Volt / 1300 mAh	CB-5614MH	\$42.00
TK260/360, KNB14A	7.5 Volt / 600 mAh	CB-5614	\$35.00
TK260/360, KNB15A	7.5 Volt / 2000 mAh	CB-5615MH	\$42.00
TK260/360, KNB15A	7.5 Volt / 1200 mAh	CB-5615	\$35.00
TK290/480, KNB17A	7.5 Volt / 1500 mAh	CB-5617	\$40.00
TK290/480, KNB17A	7.5 Volt / 2000 mAh	CB-5617MH	\$45.00

**MAXON**

0510, 0520, CA1450	11.25 Volt / 600 mAh	CB-4W	\$34.00
SP130, SP140U, SP150, MPA1200	7.5 Volt / 1200 mAh	CB-1200MP	\$42.00
SP2000, CA1155, SA1155, SA125	11.25 Volt / 700 mAh	CB-1155	\$32.00
SP2000, CA1170, SP1170, SA1270	11.25 Volt / 1400 mAh	CB-1170	\$44.00
SP300/300/320/330/340	7.2 Volt / 1500 mAh	CB-ACC20	\$37.50

**MIDLAND**

BATT6R, FRS/GMRS	4.8 Volt / 600 mAh	CB-6R	\$14.00
------------------	--------------------	-------	---------

**MOTOROLA**

BPR40,MAG ONE	7.2 Volt / 1300 mAh	CB-4071MH	\$30.00
BPR-40, MAG ONE (PMNN4075)	7.2 Volt / 1900 mAh	CB-4075LI	\$65.00
CP150, 200, PR400, NTN4496	7.5 Volt / 1050 mAh	CB-4496	\$42.00
CP150, 200, PR400, NTN4496	7.5 Volt / 1050 mAh	CB-4496XT	\$42.00
CP150, 200, PR400, NTN4851	7.5 Volt / 1650 mAh	CB-4851MH	\$46.00
CT150/250/450/450LS, PMNN4018A/AR	7.5 Volt / 1500 mAh	CB-4019-7.5	\$35.00
EX500, EX600, JMNN4023	7.4 Volt / 1800 mAh	CB-4023	\$52.00
GP300, HNN9628	7.5 Volt / 1200 mAh	CB-9628	\$34.00
GP300, HNN9628A	7.5 Volt / 1800 mAh	CB-9628MH	\$38.00
GP350, HNN9360A	7.5 Volt / 1800 mAh	CB-9360MH	\$42.00
GP350, HNN9360A	7.5 Volt / 1200 mAh	CB-9360	\$37.00
HT1000, GP900, MTX8000, HT6000, WPNN4013A	7.5 Volt / 2150 mAh	CB-7144MH	\$42.00
HT1000, MTS2000, GP900, MTX8000, HT6000,WPNN4013A	7.5 Volt / 1500 mAh	CB-7144IS	\$75.00
HT1250, HT1550, HNN9008AR	7.5 Volt / 1600 mAh	CB-9008MH	\$38.00
HT1250, HT1550, HNN9009AR	7.5 Volt / 1600 mAh	CB-9009MH	\$42.00
HT1250, HT1550, HNN9012AR	7.5 Volt / 1100 mAh	CB-9012	\$38.00
HT50, NTN5453A	10.0 Volt / 1200 mAh	CB-5453	\$32.00
HT600, 800, NTN4584BR	10.0 Volt / 800 mAh	CB-4584	\$38.00
HT600, 800, NTN4585A, 60-60930L06	10.0 Volt / 1200 mAh	CB-5414	\$33.00
HT600, 800, NTN5414 CR	10.0 Volt / 1500 mAh	CB-5414HXT	\$33.00
HT750,1250,1550, GP320,328,338,340,360, MTX850,8250,950,9250, PR860, Pro51502, 7450, 9150	7.5 Volt / 1600 mAh	CB-9009MH	\$42.00
HT750,1250,1550, GP320,328,338,340,360, MTX850,8250,950,9250, PR860, Pro51502, 7450, 9150	7.5 Volt / 1600 mAh	CB-9008MH	\$38.00
HT90, NLN7434A, NLN7435A	12.5 Volt / 700 mAh	CB-7434	\$37.00
KEBT-086B	3.6 Volt / 700 mAh	CB-KEBT086B	\$14.00
MT1000, MTX800, MTX900, NTN5447BR	10.0 Volt / 1450 mAh	CB-5447MH	\$42.00
MT1000, MTX800, MTX900, NTN5447BR	10.0 Volt / 1450 mAh	CB-5447MH	\$42.00
MT1000, MTX800, MTX900, NTN5447BR	10.0 Volt / 1200 mAh	CB-5447	\$33.00
MT500, HT220, MT700, NLN4463B	15.0 Volt / 600 mAh	CB-4463	\$34.00
MT CP150, 200, NTN4496AR	7.5 Volt / 1050 mAh	CB-4496XT	\$42.00
MT CP150, 200, PR400, NTN4497	7.5 Volt / 2000 mAh	CB-4497	\$46.00
MTS2000, GP900, MTX8000, HT6000, NTN7143A	7.5 Volt / 1200 mAh	CB-7143	\$38.00
MTS2000, GP900, MTX8000, HT6000, NTN7144A	7.5 Volt / 1500 mAh	CB-7144	\$35.00
MTS2000, GP900, MTX8000, HT6000, NTN7341A	7.5 Volt / 1500 mAh	CB-7341	\$67.00
MX300, NLN5860C	7.5 Volt / 1800 mAh	CB-5860	\$35.00
Radius CP125	7.5 Volt / 1500 mAh	CB-4063MH	\$69.00
Radius P100	10.0 Volt / 1200 mAh	CB-5451	\$36.00
Radius P100, NTN5451B	10.0 Volt / 1200 mAh	CB-5451	\$36.00
Radius P10, P50, HNN9027AR	10.8 Volt / 600 mAh	CB-9027	\$24.00
Radius P10, P50, HNN9044AR	7.5 Volt / 1000 mAh	CB-9044MH	\$24.00
Radius P10, P50(Low Power), P60, HT10, SP10, SP21, SP50	7.5 Volt / 630 mAh	CB-9044	\$19.00
Radius P110, HNN8148A	7.5 Volt / 1800 mAh	CB-8148MH	\$48.00
Radius P110, HNN8148A	7.5 Volt / 1200 mAh	CB-8148	\$32.00
Radius P1225 HNN9049A	7.5 Volt / 1500 mAh	CB-9049XT	\$45.00
Radius P1225, HNN9049AR	7.5 Volt / 1850 mAh	CB-9049MH	\$44.00
Radius P1225, HNN9049AR	7.5 Volt / 1200 mAh	CB-9049	\$38.00
Radius P200, P210, NTN5521A	10.0 Volt / 1500 mAh	CB-5521HXT	\$33.00
Radius P200, P210, NTN5521B	10.0 Volt / 1200 mAh	CB-5521	\$33.00
Radius P200, P210, NTN5521B	10.0 Volt / 1450 mAh	CB-5521MH	\$42.00
Radius SP50, HNN9018AR	7.5 Volt / 1200 mAh	CB-9018	\$24.00

Radio

**MOTOROLA ... continued from previous page**

Saber NTN4595C	7.5 Volt / 2150 mAh	CB-4595MH	\$50.00
Spirit GT280, 290, HNN9720A	3.6 Volt / 900 mAh	CB-9720A	\$38.00
Spirit, HNN9056AR	7.5 Volt / 630 mAh	CB-9044	\$19.00
T5000 Series Talkabout, 53615	3.6 Volt / .70 Ah	CB-4002	\$15.00
T5000 Series Talkabout, 53615	3.6 Volt / .80 Ah	CB-4002MH	\$19.00
T6220, 56318	3.6 Volt / 700 mAh	CB-9395	\$35.00
Visar, NTN7394BR (NiMH)	7.5 Volt / 2000 mAh	CB-7394MH	\$47.00
Visar, NTN7395BR (NiCd)	7.5 Volt / 1200 mAh	CB-7395	\$44.00
XTS1500, XTX2500	7.5 Volt / 2100 mAh	CB-9858MH	\$58.00
XTS3000, 3500, 5000, NTN4007	7.5 Volt / 4000 mAh	CB-4007-M	\$63.53
XTS3000, NTN8294AR	7.5 Volt / 1700 mAh	CB-8294	\$50.00

**MOTOROLA PAGERS**

Dimension IV, Director, Minitor, Pageboy III, Pagecom, Optrix, PMR2000, Sprit	1.3 Volt / 150 mAh	PB-6965	\$4.00
Director II, Minitor II, Pageboy II, Metro Pageboy	2.4 Volt / 170 mAh	PB-4974	\$6.00
Minitor III	1.2 Volt / 180 mAh	PB-8345	\$4.00
Minitor V (Motorola Brand Only)	3.6 Volt / 600 mAh	PB-5707	\$25.00
Pageboy, BPR 2000, Dimension 2000, Keynote	1.25 Volt / 600 mAh	PB-7057	\$6.00

**NEXTEL**

11000, NTN8614AR	3.6 Volt / 950 mAh	CB-8614L	\$33.00
------------------	--------------------	----------	---------

**REGENCY / RELM**

Relm WHS 150, BP007	11.25 Volt / 1100 mAh	CB-007	\$54.00
---------------------	-----------------------	--------	---------

**RITRON**

Patroit RTX150, 450	10.0 Volt / 1800 mAh	CB-8NMH	\$35.00
---------------------	----------------------	---------	---------

**STANDARD**

HX580, HX581T, 582T, CNB584A	10.0 Volt / 1200 mAh	CB-584	\$44.00
------------------------------	----------------------	--------	---------

**UNIDEN**

BP38/39/40, GMR, GMR1038	4.8 Volt / 700 mAh	CB-BP38	\$12.00
SPH51, SPU51, APX1070	7.5 Volt / 1200 mAh	CB-1070	\$38.00

**YAESU**

FT10R, 40R, FNB41	9.6 Volt / 700 mAh	CB-36241	\$63.00
FT10R, 40R, VX10, FBN47	7.2 Volt / 1800 mAh	CB-36247MH	\$38.00
FT10R, 40R, VX10, FNB41	9.6 Volt / 900 mAh	CB-36241MH	\$75.00
FT10R, 40R, VX10, FNB47	7.2 Volt / 1500 mAh	CB-36247	\$44.00
VX400, VX210, FBN57A	7.2 Volt / 1050 mAh	CB-36257	\$35.00
VX400, VX210, FBN57A	7.2 Volt / 1600 mAh	CB-36257MH	\$39.00
VX400, VX210, FBN67A	7.2 Volt / 1600 mAh	CB-36257MH	\$39.00

<b>ACER</b>			
AcerNote 350 Series, 352, 355, 356, 358, 361 Series, AcerNote Light 350P, 350PC, 356, 358 Series	10.8 Volt / 3800 mAh	FDR35AAS	\$129.00
AcerNote 3680, TravelMate 365 Series	8.4 Volt / 3800 mAh	FH350AE-7ATI	\$119.00
Aspire 1360, 1520, 1610, 1620, 1660, 3010, 5010 Series, Extensa 2000, 2300, 2500 Series, TravelMate 240, 250, 2000, 2500, 2600 Series	14.8 Volt / 4000 mAh	FBTP-60A1	\$149.00
Aspire 3030, 3050, 3200, 3600, 3680, 5030, 5050, 5500, 5550, 5570, 5580 Series, TravelMate 2400, 3210, 3220 Series	11.1 Volt / 4800 mAh	FBATEFL50	\$139.00
Aspire 3100, 3650, 3690, 5100, 5110, 5610, 5630, 5650, 5680, 9100, 9500, TravelMate 2350, 2450, 4050, 4150, 4200,4260, 4650, 290, 290E Series	14.8 Volt / 4400 mAh	FBATCL50L	\$129.00
Aspire 7000, 7100, 7110, 9300, 9400, 9410, 9420, 9510, 9520 Series	14.8 Volt / 4800 mAh	FBTP-BCA1	\$139.00
Extensa 500, 501, 502, 503, 505 Series, TravelMate 505, 506, 507, 508	8.4 Volt / 3800 mAh	FH350AE-8ATI	\$99.00
Extensa 5210, 5220, 5420, 5430, 5610, 5620, 7120, 7140 Series,TravelMate 5310, 5320, 5520, 5710, 5720, 7220, 7520 Series	11.0 Volt / 4000 mAh	FBTPL06	\$129.00
N10	3.7 Volt / 1700 mAh	PDA24	\$46.00
N30, N35 Series	3.7 Volt / 1000 mAh	PDA138	\$43.00
S60	3.7 Volt / 950 mAh	PDA34	\$25.00
TravelMate 200, 210 Series	9.6 Volt / 4000 mAh	FBTP-33A1	\$109.00
Travelmate 330, 332, 333, 340, 341, 31, 343, 345, 347 Series	10.8 Volt / 2800 mAh	FBTP-25D1	\$219.00
TravelMate 5000, 5000M, 5200, 5270, 5300, 5370, 5375 Series	10.8 Volt / 2600 mAh	FL18650-6TM	\$189.00
TravelMate 520, 521, 522, 524, 525, 527, 529 Series	14.8 Volt / 3600 mAh	FBTP-34A1	\$209.00
TravelMate 600, 602, 603, 604, 600TER, 602TER, 603TER, 604TER	14.8 Volt / 3600 mAh	FL18650-TM600	\$209.00
TravelMate 620, 621, 622, 623, 624, 630, 631, 632, 633, 634, 636 Series	14.8 Volt / 4000 mAh	FBTP-39D1	\$209.00
TravelMate 730, 732, 734, 735, 736, 737, 738, 739, 740, 741, 744 Series	11.1 Volt / 5880 mAh	FBTP-38A1	\$209.00

<b>APPLE</b>			
iBook Blueberry, Clamshell, FireWire, Graphite, Indigo, Green, Tangerine	14.4 Volt / 4000 mAh	FL18650-PBIB	\$129.00
IPOD new slim models, 616-0159, E225846	3.7 Volt / 850 mAh	PDA33	\$20.00
IPOD older. not slim models, UP325385A4H, UP325385A5H	3.7 Volt / 1200 mAh	PDA36	\$26.00
MacBook 13 inch, 13.3 inch Series	11.1 Volt / 5100 mAh	FA1185	\$149.00
PowerBook 140, 145, 150, 160, 165, 170, 180	6.0 Volt / 2800 mAh	FP140AS-10PB	\$64.00

<b>ARCOS</b>			
AV320 (Li-Ion)	3.7 Volt / 2800 mAh	PDA49	\$57.00

<b>ARM COMPUTER</b>			
ArmNote 175, 795, 795+, 797, 982, TS795CD (Li-Ion)	11.1 Volt / 6000 mAh	FDR202/DR202i	\$119.00
ArmNote N38W, N38W2, TS30W, TS30W2, TS38W (Li-Ion)	11.1 Volt / 4800 mAh	F2127U	\$189.00
ArmNote NB34B, NB34BS, NB34BS1, NB34BS2, NB34BS3, NB34BS8, NB35,NB35B, NB35BS1, NB35BS2, NB35BS8	11.1 Volt / 5850 mAh	FBP34BS1	\$119.00

<b>AST</b>			
Ascentia A40, A41, A42, A43, A51, A60+, A70+, M, M5130S, M5130T, M5150T, M5160T, M5160X, M5200T, M5200X, M5230T, M5230X, M5260X, M6000, M6233T, M6266T Series (Li-Ion)	11.1 Volt / 6000 mAh	FDR202/DR202i	\$119.00

<b>AST ... continued from previous page</b>			
Ascentia A40, A41, A42, A43, A51, A60+, A70+, M, M5130S, M5130T, M5150T, M5160T, M5160X, M5200T, M5200X, M5230T, M5230X, M5260X, M6000, M6233T, M6266T Series (NiMH)	12.0 Volt / 3800 mAh	FDR36AAS	\$149.00

<b>ASUS</b>			
My Pal A620 (Li-Ion)	3.7 Volt / 1500 mAh	PDA86	\$56.00

<b>AUDIOVOX</b>			
6600, PPC6600, PPC6601, VX6600	3.7 Volt / 1500 mAh	PDA132	\$52.00
LAB544060C, Maestro PDA 1032, 1032C, Thera Pocket PC (Li-Ion)	3.7 Volt / 1200 mAh	PDA60	\$38.00
SMT5600 (Li-Ion)	3.7 Volt / 1050 mAh	PDA107	\$22.00

<b>BLACKBERRY</b>			
ACC-07494-001, ACC-07496-001, 5061, 5068, RIM-7100, 7100G, 7100L,7100R, 7100T, 7100V, 7100X, 7105T, 7130E, 8700C, 8700F, 8700G,ACC-10477-001, BAT-06860-001, C-S1, C-S2 (Li-Ion)	3.7 Volt / 900 mAh	PDA115	\$25.00
ASY-02965-001, R957, R957M, R957M-2, R957M-5 (Li-Ion)	3.7 Volt / 1300 mAh	PDA76	\$38.00
Blackberry 7130E	3.7 Volt / 900 mAh	PDA157	\$25.00
RIM 6210, 6230, 6280, 6510, 6710, 6750, 7210, 7230, 7280, 7510, 7750,BAT-03087-002 (Li-Ion)	3.7 Volt / 960 mAh	PDA26	\$25.00

<b>CASIO</b>			
Cassiopeia BE-300, CGA-1-105A (Li-Ion)	3.7 Volt / 800 mAh	PDA52	\$45.00
Cassiopeia E-100, E-105, E-115, E-E125, E-125 CSC Series, JK-210LT	3.7 Volt / 1400 mAh	PDA9	\$30.00
Cassiopeia E-200, JK-214LT, JK-835PU, MR-CE200 (Li-Ion)	3.7 Volt / 1000 mAh	PDA29	\$55.00
Cassiopeia EG-800STD, EG-800STD-S, JK-210RB, RBL, RBM (Li-Ion)	3.7 Volt / 1650 mAh	PDA53	\$55.00
Cassiopeia EM-500, 500BU, 500GN, 500RD, 500SB, 500TW, JK211-LT	3.7 Volt / 1100 mAh	PDA28	\$47.00
DT-5023BAT, DT-5024LBAT, IT-70, IT-700 (Li-Ion)	3.7 Volt / 1650 mAh	PDA62	\$52.00

<b>COMPAQ</b>			
360136-001	3.7 Volt / 1700 mAh	PDA89	\$57.00
Aero 1500 Series, PE2021, 136175-B21, 136283-001, 144064-001, 146656-001	3.7 Volt / 850 mAh	PDA58	\$42.00
Armada 1100, 1100T Series, Contura 400C, 400CX Series, Contura Aero 4/25, 4/33C Series	10.8 Volt / 3800 mAh	FH240AE-9CA	\$99.00
Armada 1500, 1500C, 5200 Series, Armada 2923, Armada SMB Series	14.4 Volt / 3200 mAh	FL18650-CA15	\$219.00
Armada 1700, 1750 Series	14.4 Volt / 3200 mAh	FL18650-CA17	\$209.00
Armada 7400 Series	14.4 Volt / 3000 mAh	FL18650-CA74	\$189.00
Armada E500, E500S, V300 Series, Prosignia 190 Series	11.1 Volt / 5400 mAh	FL18650-CE50	\$209.00
Armada M300 Series, Evo N200 Series, Presario 300 Series	14.8 Volt / 1960 mAh	FL18650-CM30	\$189.00
Armada M700, Prosignia 170 Series	14.8 Volt / 3600 mAh	FL18650-CM70	\$209.00
Business NoteBook N1050v, NX9000 Series, Evo N1050v Series,Presario 2100, 2200, 2500, 1100 Series	14.8 Volt / 4400 mAh	FL18650-8ZEX	\$149.00
Business NoteBook NC4200, NC4400, Tablet PC TC4200, TC4400 Series	10.8 Volt / 4800 mAh	FL18650-6NTC	\$139.00
Business NoteBook NC6000, NC8000, NW8000, NX5000 Series, Evo N1000, N1000C Series, Evo N1010, N1010V, N1015, N1015V,N1020, N1020V Series, Presario 900, 1500 Series	14.8 Volt / 4400 mAh	FL18650-CPND	\$119.00

**COMPAQ ... continued from previous page**

Business NoteBook NC6100, NC6200, NC6300, NC6400 Series, Business NoteBook NX6100, NX6105, NX6110 Series	10.8 Volt / 4400 mAh	FL18650-6NCX	\$139.00
Business NoteBook NC8230, NC8430, NW8240, NW8440, NW9440, NX7300, NX7400, NX8220, NX8410, NX8420, NX9420 Series	14.8 Volt / 4800 mAh	F372771-001	\$149.00
Business Notebook NX4800, NX7200 Series, Presario C300, M200, M2100, M2200, M2300, M2400, V2000, V2100, V2200, V2300, V2400T, V2500, V2600, V2600T, V2600Z, V4000, V4000T, V4100, V4200, V4300, V4400, V5000, V5000CTO, V5000T, V5000Z, V5100, V5100AU/TU, V5100CTO, V5100Z, V5200, V5200CTO, V5300, V5300CTO Series	10.8 Volt / 4500 mAh	FL18650-6ZVM	\$119.00
Business NoteBook NX9100, NX9105, NX9110 Series, Presario R3000, R3100, R3200, R3300, R3400, R4000, R4100, R4200 Series	14.8 Volt / 4400 mAh	FL18650-8ZRX	\$119.00
Business NoteBook NX9600 Series, Presario x6000, x6100 Series	14.8 Volt / 6600 mAh	FL18650-12ZRX	\$139.00
Contura 3/20, 3/25, 3/25C, 386, 4/25, 4/25C, 4/25CX, 486 Series	12 Volt / 1700 mAh	FP170AE-10C	\$88.00
Evo N1000V, N1005V, N800, N800c, N800v, N800w Series, Presario 2800, V1000, V1100 Series	14.8 Volt / 4000 mAh	FL18650-CP3XD	\$139.00
Evo N105, N115 Series, Presario 14XL, 700, 1400 Series	14.8 Volt / 3600 mAh	FL18650-CP700	\$189.00
Evo N160 Series, Presario 17XL, 17XL2, 1700 Series	14.8 Volt / 3600 mAh	FL18650-CP17	\$189.00
Evo N180 Series, Presario 2700 Series	14.8 Volt / 4000 mAh	FL18650-CP27	\$159.00
Evo N600c, N610c, N610v, N620c Series	14.4 Volt / 4000 mAh	F232633-001	\$159.00
H4300, H4350, 343117-001, 343132-001, 347703-001, FA189A, FA189A#AC3	3.7 Volt / 2000 mAh	PDA61	\$95.00
iPAQ 1910, H1910, 1940, H1940, 311314, 311315-B21	3.7 Volt / 950 mAh	PDA18	\$22.00
iPAQ 2200, H2200 Series, FA103A, FA159A, 310798, 311949-001	3.7 Volt / 950 mAh	PDA17	\$35.00
iPAQ H1900, H1910, H1915, H1920, H1930, H1935, H1937, H1940, H1945	3.7 Volt / 900 mAh	FFP114A	\$39.00
iPAQ H2200, H2210, H2212e, H2215 Series	3.7 Volt / 900 mAh	FFP110A	\$49.00
iPAQ H3100, H3600, H3700 Series	3.7 Volt / Ah	PDA1	\$25.00
iPAQ H3800, H3900 Series	3.7 Volt / 1400 mAh	PDA2	\$41.00
iPAQ H4800, HX4000, 359113-001	3.7 Volt / 1800 mAh	PDA93	\$41.00
iPAQ H5000 Series	3.7 Volt / 1400 mAh	FFP139A	\$44.00
iPAQ H5450, H5455, H5470, H5550, 290483-B21, F139A	3.7 Volt / 1400 mAh	PDA40	\$38.00
iPAQ H6300 Series, iPAQ Pocket PC H6300	3.7 Volt / 1800 mAh	PDA113	\$44.00
iPAQ hw6500, 377358-001	3.7 Volt / 1200 mAh	PDA135	\$41.00
iPAQ HX4700, HX4800 Series	3.7 Volt / 1800 mAh	FFP257A	\$49.00
iPAQ RX3115	3.7 Volt / 1500 mAh	PDA91-15	\$31.00
iPAQ RX3115	3.7 Volt / 1000 mAh	PDA91	\$30.00
Presario 1200, 1200T, 1200TA, 1200XL, 1600, 1600T, 1600XL, 1800, 1800T, 1800XL Series, Presario 12XL, 16XL, 18XL, 18XL2, Prosignia 150	9.6 Volt / 4000 mAh	FH240AE-CP16	\$109.00
Presario 1200, 1600, 1800 Series	14.4 Volt / 3600 mAh	FL18650-CP16	\$119.00
Presario C300, C500, M2000, V2000, V4000, V5000 Series	10.8 Volt / 8800 mAh	FL18650-12ZVM	\$159.00
Presario CQ40, CQ45, CQ50 Series	10.8 Volt / 4400 mAh	FL18650-DV45	\$124.00
Presario V3000, V3000T, V3000Z, V6000, V6000AU, V6000Z Series	10.8 Volt / 4400 mAh	FL18650-6DVV	\$119.00
Tablet PC TC1000, TC1100 Series	11.1 Volt / 3600 mAh	FL103450-6TC	\$149.00

**DELL**

Axim X3, X30, X3i, F2751, F2753, W1359, X1111, 310-4263, 310-4268	3.7 Volt / 1000 mAh	PDA54	\$28.00
Axim X3, X30, X3i Series	3.7 Volt / 1700 mAh	FX1111	\$29.00
Axim X50, X50V, X51, X51V, HC03U, T6476, T6845, X50, X50V, X51, X51V, 310-5964, 35H00056-00	3.7 Volt / 1100 mAh	PDA95	\$26.00

<b>DELL ... continued from previous page</b>			
Axim X50, X50v, X51, X51v Series	3.7 Volt / 1100 mAh	FT6476	\$34.00
Axim X5, 1X390, F0089	3.7 Volt / 2000 mAh	PDA27	\$38.00
Inspiron 1100, 1150, 5100, 5150, 5160 Series, Latitude 100L Series	14.8 Volt / 6450 mAh	F7T670	\$149.00
Inspiron 1300, B120, B130 Series, Latitude 120L Series	11.1 Volt / 4500 mAh	FXD187	\$139.00
Inspiron 1525, 1526 Series	11.1 Volt / 4400 mAh	FBPM5330	\$144.00
Inspiron 2100 Series, Latitude L400, LS, LSH400ST, LSH500T, LSTC400ST,LSTC400XT, LST Series	11.1 Volt / 2800 mAh	F4834T	\$169.00
Inspiron 2500, 3700, 3800, 4000, 4100, 4150, 8000, 8100, 8200 Series, Latitude C500, C510, C540, C600, C610, C640, C800, C810, C840, CP, CPi, CPt, CPx, M40, M50, PP01L, PP01X Series, Precision M40, M50 Series, Precision Workstation M40, M50 Series, SmartStep 100N Series	14.8 Volt / 4460 mAh	F53977	\$129.00
Inspiron 2600, 2650 Series, Latitude V710, V740 Series, Smart PC 100N	14.8 Volt / 3900 mAh	F1G222	\$149.00
Inspiron 5000 Series	11.1 Volt / 4800 mAh	F2127U	\$189.00
Inspiron 500M, 600M Series, Latitude D500, D505, D510, D520, D600,D610 Series, Precision M20 Series, Precision Workstation M20 Series	11.1 Volt / 4700 mAh	F4M983	\$119.00
Inspiron 6000, 9200, 9300, 9400, E1705 Series, Precision M90 Series, Precision Workstation M90 Series, XPS, XPS M170, XPS Generation 2 Series, XPS M1710 Series	11.1 Volt / 4800 mAh	FD5318	\$139.00
Inspiron 6400, E1501, E1505 Series, Latitude 131L Series, Vostro 1000 Series	11.1 Volt / 7800 mAh	FKD476	\$149.00
Inspiron 700M, 710M Series	14.8 Volt / 4800 mAh	FBTP-83M-DELL	\$159.00
Inspiron 8500, 8600, 8600C Series, Latitude D800 Series, Precision M60 Series,Precision Workstation M60 Series	11.1 Volt / 6490 mAh	F5P142	\$139.00
Inspiron and Latitude Series	14.8 Volt / 4400 mAh	F08M815	\$119.00
Inspiron XPS M1210 Series	11.1 Volt / 7650 mAh	FCG039	\$159.00
Latitude 433MC, 450MC, 475C, 475MC, LX4100, M Series	12.0 Volt / 2200 mAh	FH180AE-10ASD	\$95.00
Latitude C400 Series	11.1 Volt / 3600 mAh	F01J989	\$159.00
Latitude D410 Series	11.1 Volt / 4400 mAh	FY6142	\$139.00
Latitude D420 Series	11.1 Volt / 5850 mAh	FPG043	\$149.00
Latitude D620, D630, D630N, D631, D631N, D830N, Precision M2300 Series	11.1 Volt / 7200 mAh	FTD175	\$149.00
Latitude D620 Series	11.1 Volt / 5200 mAh	FJD634	\$139.00
Latitude D810, M70 Series, Precision M70, Precision Workstation M70 Series	11.1 Volt / 7200 mAh	FC5331	\$139.00
Latitude D820 Series, Precision M65, Precision Workstation M65 Series	11.1 Volt / 7200 mAh	FCF711	\$159.00

<b>DOPD</b>			
565, 575, 585	3.7 Volt / 1050 mAh	PDA107	\$22.00
E700 (Li-Ion)	3.7 Volt / 1500 mAh	PDA132	\$52.00

<b>FUJITSU</b>			
Amilo, A1630, D1840, D1845	14.4 Volt / 4400 mAh	FBP258	\$139.00
Amilo M1450, M6300, M6800, M7300, M7800, M8300, M8800, LifeBook C1010, C1020, C1110, C1110D, FMV FM-4, FMV-612NU2/E	14.8 Volt / 4000 mAh	FL18650-8XFZ	\$139.00
iPAD 100, 100-10, 100-10-RF, 100-14, 100-14RF, 142-01, 142-RFI Series	3.7 Volt / 1650 mAh	PDA62	\$52.00
LifeBook B6000D, B6110, B6110D, B6210, B6220 Series	7.2 Volt / 7800 mAh	FFPCBP152	\$149.00
LOOX	3.7 Volt / 1700 mAh	PDA24	\$46.00

**FUJITSU ... continued from previous page**

Stylistic LT233	11.1 Volt / 6000 mAh	FDR202/DR202i	\$119.00
-----------------	----------------------	---------------	----------

**GARMIN**

010-10567-08, IQUE M5 (Li-Ion)	3.7 Volt / 1250 mAh	PDA119	\$95.00
1A2W423C2, IQUE 3600 GPS (Li-Ion)	3.7 Volt / 1000 mAh	PDA35	\$46.00

**GATEWAY**

6000, 6500, 8500, M255, M360, M460, M680, MX3000, MX6000, MX8500, NX500, NX550, NX850, NX860, S-7500N, S-7700N Series	14.8 Volt / 4800 mAh	FL18650-8MSBG	\$149.00
6000, 8000 Series, M360, M360A, M360B, M360C, M460, M460A, M460B, M460QS, M465-E, M465-G, M465E, M465G, M680, M685-E, M685-G, MP6954, MP6954h, MP8708, MX3311b, MX3410, MX3410h, MX3412, MX3412h, MX3414, MX3416, MX3417, MX3701, MX3702, MX6000, MX8000 Series, NX260X, NX500S, NX500X, NX510S, NX510X, NX550X, NX550XL, NX560X, NX560XL, NX570QS, NX570X, NX570XL, NX850X, NX850XL, NX860X, NX860XL Series, S-7500N, S-7510N, S-770N, S-7710N	14.8 Volt / 4500 mAh	FL18650-8MSB	\$139.00
600 Series, M600 Series, Solo 600YG2, 600YGR Series	11.1 Volt / 6000 mAh	FL18650-GW600	\$159.00
7000 Series, M520, MX7000 Series	14.8 Volt / 4400 mAh	FL18650-8EMG	\$149.00
ColorBook 2, 486DX/33, 486DX/35, 486SX/25, 486SX/33, DX2/50, DX33, DX4/75 Series	12 Volt / 3800 mAh	FH240AE-10GWL	\$119.00
CX200S, CX200X, CX210S, CX210X, CX2608, CX2610, CX2615, CX2618, CX2619, CX2620, CX2620h, CX2720, CX2724, CX2724h, CX2726 Series, M280, M280E, M285, M285-EG, M285-ESB, M285-G, M285EG, M285E, M285E-G, M285E-SB Series, S-7200C Convertible Series	14.8 Volt / 5200 mAh	FBATSQU508	\$159.00
M305, M305CRV, M405, M405X, M405XL Series	14.8 Volt / 4500 mAh	FL18650-8GTB	\$139.00
Solo 1400, 1450, 1450SE Series	14.8 Volt / 4000 mAh	FL18650-8XFZ	\$139.00
Solo 2300, 2500, 2500LS, 2500SE, 2550, 9100, 9150 Series	14.8 Volt / 5400 mAh	FL18650-12GWS	\$149.00
Solo 400SP Plus, 400SP, 400VSP, 400VTX, 450E, 450RGH, 450ROG, 450SX4, 450X, 450XL Series	14.8 Volt / 4500 mAh	FL18650-8GTX	\$139.00
Solo 9300, 9300VE, Pro 9300-E Series	11.1 Volt / 7200 mAh	FL18650-GWS93	\$229.00

**HANDSPRING**

14-0006-00, VISOR PRISM (Color) (Li-Ion)	3.7 Volt / 1800 mAh	PDA7	\$21.00
14-0007-00, VISOR EDGE (B&W) (Li-Ion)	3.6 Volt / 1000 mAh	PDA3	\$21.00
14-0019-02, HND 14-0019-02, TREO 180, 180G, 90 (Li-Ion)	3.7 Volt / 1000 mAh	PDA6	\$21.00
14-0024-00, HND 14-0024-00, TERO 270, 300 (Li-Ion)	3.7 Volt / 950 mAh	PDA19	\$21.00
TREO 600 (Li-Ion)	3.7 Volt / 1700 mAh	PDA78	\$38.00
VISOR PRO (Li-Ion)	3.7 Volt / 800 mAh	PDA87	\$36.00

**HEWLETT PACKARD**

350525-001, FA235A#AC3, FA236A#AC3	3.7 Volt / 1800 mAh	PDA113	\$44.00
Business Notebook 8530P, 8530W, 8540P, 8540W, 8730P, 8730W, 8740W	14.4 Volt / 5100 mAh	FL18650-8EB	\$149.00
Business NoteBook N1050v, NX9000 Series, OmniBook xe4100, xe4400, xe4400s, xe4500 Series, Pavillion xt100, xt200, xt300, xt400, xt4000, xt500, xt5000, ze4100, ze4200, ze4300, ze4400, ze4500, ze4600, ze4700, ze4800, ze4900, ze5000, ze5100, ze5200, ze5300, ze5400, ze5500, ze5600, ze5700	14.8 Volt / 4400 mAh	FL18650-8ZEX	\$149.00



**HEWLETT PACKARD ... continued from previous page**

Business NoteBook NC4200, NC4400 Series, Tablet PC TC4200, TC4400	10.8 Volt / 4800 mAh	FL18650-6NTC	\$139.00
Business NoteBook NC6000, NC8000, NW8000, NX5000 Series	14.8 Volt / 4400 mAh	FL18650-CPND	\$119.00
Business NoteBook NC6100, NC6200, NC6300, NC6400, NX6100, NX6300	10.8 Volt / 4400 mAh	FL18650-6NCX	\$139.00
Business NoteBook NC8200, NC8400, NW8200, NW8400, NW9400, NX7300, NX7400, NX8200, NX8400, NX9400 Series	14.8 Volt / 4800 mAh	F372771-001	\$149.00
Business NoteBook NX4800, NX7200 Series, Pavillion dv1000, dv1100, dv1200, dv1300, dv1400, dv1500, dv1600, dv4000, dv4100, dv4200, dv4300, dv4400, dv5000, dv5100, dv5200, dv5300, ze2000, ze2100, ze2200, ze2300, ze2400, ze2500, zt4000 Series, Special Edition L2000, L2002CX, L2005A3, L2005A4, L2005CL, L2005CM, L2005CO, L2005CU, L2005CX, L2005US, L2098XX, L2099XX, L2105CA, L2105CL, L2105NR, L2205NR, L2300, L2310CU Series	10.8 Volt / 4500 mAh	FL18650-6ZVM	\$119.00
Business NoteBook NX9100 Series, Pavillion zv5000, zv5100, zv5200, zv5300, zv5400, zv6000, zv6100, zv6200 Series	14.8 Volt / 4400 mAh	FL18650-8ZRX	\$119.00
Business NoteBook NX9600 Series, Pavillion zd8000, zd8100, zd8200, zd8300, zx5000, zx5100, zx5200, zx5300 Series	14.8 Volt / 6600 mAh	FL18650-12ZRX	\$139.00
G3000, G5000 Series, Pavilion dv1000, dv4000, dv5000, ze2000 Series, Notebook NX4800, NX7200 Series	10.8 Volt / 8800 mAh	FL18650-12ZVM	\$159.00
iPAQ H1900 Series	3.7 Volt / 900 mAh	FFP114A	\$39.00
iPAQ H2200 Series	3.7 Volt / 900 mAh	FFP110A	\$49.00
iPAQ H4150, H4155, 343110-001	3.7 Volt / 1100 mAh	PDA37	\$27.00
iPAQ H4150, H4155, 343110-001	3.7 Volt / 1800 mAh	PDA37HC	\$31.00
iPAQ H5000 Series	3.7 Volt / 1400 mAh	FFP139A	\$44.00
iPAQ HX2000, RX3000, 2750, FA285A#AC3, FA286A#AC3	3.7 Volt / 1700 mAh	PDA89	\$57.00
iPAQ HX4700, HX4800 Series	3.7 Volt / 1800 mAh	FFP257A	\$49.00
iPAQ RX3100, RX3400, RX3415, RX3700, RX3715, 354401-001, 367205-001	3.7 Volt / 2880 mAh	PDA91-3	\$38.00
iPAQ RX3100, RX3400, RX3415, RX3700, RX3715, 354401-001, 367205-001	3.7 Volt / 1500 mAh	PDA91-15	\$31.00
iPAQ RX3100, RX3400, RX3415, RX3700, RX3715, 354401-001, 367205-001	3.7 Volt / 1000 mAh	PDA91	\$30.00
iPAQ RZ1700, RZ1710, RZ1715, RZ1717, 367194-001	3.7 Volt / 950 mAh	PDA90	\$30.00
Jornada 420, 428, 430, F1255-80055, F1255A, F1287A	3.6 Volt / 1850 mAh	PDA45	\$38.00
Jornada 520, 525, 540, 545, 547, 548, F1798, F1798-60918, F1798-80003	3.7 Volt / 2000 mAh	PDA10	\$21.00
Jornada 560, 565, 568, 580, F2091A, F2091B	3.7 Volt / 1320 mAh	PDA44	\$51.00
Jornada 680, 690, 710, 720, 728, F1262-80001, F1281A, F4356-8004, F4361A	7.2 Volt / 1150 mAh	PDA42	\$55.00
OmniBook 2100, 3000, 3100 Series	9.6 Volt / 4000 mAh	FHP-F1589A	\$89.00
OmniBook 2100, 3000, 3100 Series	14.4 Volt / 3200 mAh	FL18650-8DHL	\$199.00
OmniBook 500, 500B Series, Pavillion xu155, zu115, zu1175, zu175 Series	11.1 Volt / 3600 mAh	FHP-F2098A	\$159.00
OmniBook 6000, 6100, vt6200, xt6050, xt6200 Series	14.8 Volt / 3600 mAh	FL18650-HP60	\$139.00
OmniBook XE3 Series, Pavillion n5100, n5200, n5300, n5400, n6100, n6300, n6400, xh100, xh200, xh300, xh400, xh500, xh600 Series	11.1 Volt / 5400 mAh	FL18650-XE3	\$119.00
OmniBook XE3, XE3L Series, Pavillion n5000, n5100, n5200, n5300, n5400, n6000, n6100, n6300, n6400 Series	10.8 Volt / 4000 mAh	FH400AE-XE3	\$109.00
OmniBook XE Series, Pavillion n3000 Series	14.8 Volt / 3600 mAh	FL18650-8XE	\$129.00
Pavillion dv2000, dv2100, dv6000, dv6100, dv6200 Series	10.8 Volt / 4400 mAh	FL18650-6DVV	\$119.00
Tablet PC TC1000, TC1100 Series	11.1 Volt / 3600 mAh	FL103450-6TC	\$149.00

<b>HTC</b>			
Blue Angel, Himalayas	3.7 Volt / 1500 mAh	PDA132	\$52.00
Feeler, Typhoon	3.7 Volt / 1050 mAh	PDA107	\$22.00
Tanager	3.7 Volt / 950 mAh	PDA105	\$38.00

<b>IBM</b>			
Lenovo ThinkPad X60, X61 Tablet Series	14.4 Volt / 2000 mAh	F42T5250	\$139.00
ThinkPad 1100i, 1200i, 1210i, 1230i, 1250i, 1260i, 1300i Series, 130i Series	9.6 Volt / 4500 mAh	FH450AE-8TPI	\$109.00
ThinkPad 1400i, 1410i, 1411i, 1436i, 1450i, 1451i	9.6 Volt / 3800 mAh	FH350AE-8TPI	\$99.00
ThinkPad 1412i, 1452i, 1472i, 1500i, 1512i, 1552i	14.8 Volt / 3200 mAh	FL18650-8TPI	\$179.00
ThinkPad 1420i, 1421i, 1422i, 1440i, 1441i, 1442i, 1460i, 1480i, 1482i, 1483i, 1490i, 1492i, 1540i, 1541i, 1542i, 1560i, 1562i, 1592i	10.8 Volt / 5400 mAh	FL18650-9TPI	\$189.00
ThinkPad 1720i, 1721i, 1750i, 390, 390E, 390X Series	9.6 Volt / 4500 mAh	FH450AE-TP390	\$129.00
ThinkPad 365, 365C, 365CD, 365CS, 365CSE, 365E, 365ED, 365X, 365XD	9.6 Volt / 3800 mAh	FH300AE-8TP	\$99.00
ThinkPad 370, 750, 750C, 750P, 755, 755C, 755CS	9.6 Volt / 3600 mAh	FH160AE-16TP	\$155.00
ThinkPad 380, 380D, 380E, 380ED, 380XD, 380Z, 385, 385D, 385ED, 385XD	8.4 Volt / 3800 mAh	FH350AE-TP38	\$129.00
ThinkPad 380, 385 Series	10.8 Volt / 3600 mAh	FL18650-TP38	\$119.00
ThinkPad 390, 390E, 390X, 1700i, 1720i, 1721i, 1750i Series	10.8 Volt / 5400 mAh	FL18650-TP390	\$149.00
ThinkPad 570, 570E	10.8 Volt / 2800 mAh	FL345010-6ITP	\$199.00
ThinkPad 600, 600D, 600E, 600X, 660 Series	10.8 Volt / 3600 mAh	FL18650-6ITP	\$139.00
ThinkPad 770, 770D, 770E, 770ED, 770U, 770X, 770Z	10.8 Volt / 5400 mAh	FL18650-9ITP	\$219.00
ThinkPad A20, A20m, A20p, A21, A21m, A21p, A22, A22m, A22p Series	10.8 Volt / 5400 mAh	FL18650-9TPA	\$139.00
ThinkPad A30, A30p, A31, A31p	10.8 Volt / 4000 mAh	FL18650-6A30	\$149.00
ThinkPad R30, R31 Series	10.8 Volt / 4000 mAh	FL18650-6R30	\$139.00
ThinkPad R32, R40 Series	14.4 Volt / 4000 mAh	FL18650-8R32	\$139.00
ThinkPad R50, R50e, R50p, R51, R51e, R51p, R52, R52p, T40, T40P, T41, T41P, T42, T42P, T43, T43P Series	10.8 Volt / 7200 mAh	F08K8197	\$149.00
ThinkPad R50, R50e, R50p, R51, R51e, R51p, R52, R52p, T40, T40P, T41, T41P, T42, T42P, T43, T43P Series	10.8 Volt / 4400 mAh	F08K8214	\$119.00
ThinkPad R60, R60e, T60, T60p Series, 0656, 0657, 0658, 0659, 1951, 1952, 1953, 1954, 1955, 1956, 2007, 2008, 2009, 2613, 2623, 2637, 9444, 9445, 9446, 9447, 9455, 9456, 9457, 9458	10.8 Volt / 5200 mAh	F92P1137	\$139.00
ThinkPad T20, T21, T22, T23 Series	10.8 Volt / 3600 mAh	FL18650-6TPT	\$109.00

<b>I-MATE</b>			
PDA2K	3.7 Volt / 1500 mAh	PDA132	\$52.00
Smartphone	3.7 Volt / 950 mAh	PDA105	\$38.00
SP3, SP3I, SP4M, SP5M	3.7 Volt / 1050 mAh	PDA107	\$22.00

<b>IRIVER</b>			
IHP-H110, IHP-H120, IHP-H140, IHP-H320	3.7 Volt / 1600 mAh	PDA68	\$32.00

<b>MITAC</b>			
MIO 338	3.7 Volt / 1100 mAh	PDA129	\$42.00

<b>MOTOROLA</b>			
A380, A388, SNN5714	3.6 Volt / 900 mAh	PDA99	\$15.00
A6188, A6288, Accompli 008, A008, SNN5712	3.7 Volt / 1000 mAh	PDA97	\$15.00
A760, A768, A780, SNN5683	3.7 Volt / 850 mAh	PDA96	\$15.00

**MOTOROLA ... continued from previous page**

A840, A860, E815, SNN5695, SNN5695A, V710, V860	3.7 Volt / 650 mAh	PDA117	\$16.00
---	--------------------	--------	---------

**NEC**

LaVie L Series LL1000N/84DH, LL300/1A, LL500/1D, LL500/2D, LL500/3D, LL550/3D, LL700R/73AR, LL700R/73DH, LL700R/73DR, LL800R/74DH, LL800R/84DH, LaVie Pro Series LH300/2A, LH300/3F	9.6 Volt / 4000 mAh	FH240AE-CP16	\$109.00
Mobile Gear MC-R700, Mobile Pro 800, 880 Series, 808-892309-001	11.1 Volt / 1400 mAh	PDA100	\$130.00
Mobile Pro 400, 450, 700, MP400, MP700, S1424-15, S1424-15A	2.4 Volt / 1600 mAh	PDA101	\$21.00
Mobile Pro P300, 07-016006345	3.7 Volt / 1000 mAh	PDA55	\$42.00
Versa 6000, 6000H, 6010H, 6030H, 6030X, 6050MH, 6050MX, 6050NT, 6060,6200, 6200MX, 6200NT, 6220, 6230, 6260	14.4 Volt / 3600 mAh	FL18650-8NEC	\$209.00
Versa FP440 Series	14.8 Volt / 4000 mAh	FBTP-39D1	\$209.00

**NOKIA**

9110, 9110i	3.7 Volt / 1150 mAh	PDA106	\$21.00
9210, 9290	3.7 Volt / 1150 mAh	PDA104	\$25.00

**O2**

PH26B, XDA III, XDAIIS	3.7 Volt / 1500 mAh	PDA132	\$52.00
Smart Phone II, SP II, XDA Orion, Xphone IIM, Xphone II	3.7 Volt / 1050 mAh	PDA107	\$22.00

**ORANGE**

SPV-C500, SPV-C500S, SPV-C550, SPV-C600	3.7 Volt / 1050 mAh	PDA107	\$22.00
SPV-E100	3.7 Volt / 950 mAh	PDA105	\$38.00
SPVM2000	3.7 Volt / 1500 mAh	PDA132	\$52.00

**PALM**

169-2492, i705, LIS2106, TUNGSTEN C, W, W&C (Li-Ion)	3.7 Volt / 1700 mAh	PDA25	\$35.00
170-0737, IIIC (Li-Ion)	3.7 Volt / 1800 mAh	PDA5	\$21.00
F21918595, M130, M135 (Li-Ion)	3.7 Volt / 850 mAh	PDA11	\$21.00
IA1TA16A0, M550, TUNGSTEN T (Li-Ion)	3.7 Volt / 950 mAh	PDA12	\$25.00
IA1W721H2, TUNGSTEN T1, T2, T3, ZIRE 71 (Li-Ion)	3.7 Volt / 950 mAh	PDA38	\$25.00
ICF383461, M500, M505, M515, S3261, UP383526A (Li-Ion)	3.7 Volt / 650 mAh	PDA4	\$21.00
Life Drive Mobile Manager	3.7 Volt / 1700 mAh	PDA120	\$21.00
M150, M155	3.7 Volt / 600 mAh	PDA108	\$15.00
Treo 600	3.7 Volt / 1700 mAh	PDA78	\$38.00
Treo 650	3.7 Volt / 1800 mAh	PDA109	\$31.00
Tungsten E	3.7 Volt / 850 mAh	PDA79	\$37.00
Tungsten E2	3.7 Volt / 1200 mAh	PDA162	\$38.00
VII Modem Battery, VIIX Modem Battery (NiCd)	6.0 Volt / 50 mAh	PDA46	\$38.00
V, VX (Li-Ion)	3.7 Volt / 650 mAh	PDA16	\$19.00
ZIRE 150, 21 (Li-Ion)	3.7 Volt / 800 mAh	PDA47	\$31.00

**PANASONIC**

CF-V41	9.6 Volt / 2100 mAh	FH180AE-8PCD	\$119.00
ToughBook CF-18, CF-18A, CF-18B, CF-18D, CF-18F, CF-18G, CF-18H,CF-18K	7.4 Volt / 6750 mAh	FL18650-CF18	\$129.00
ToughBook CF-25, CF-25MKII	9.6 Volt / 3800m Ah	FH350AE-8CF	\$149.00
ToughBook CF-27	10.8 Volt / 4500 mAh	FL17670-9CF	\$209.00
ToughBook CF-28, CF-28M, CF-28P CF-28S, CF-48, CF-50	11.1 Volt / 6750 mAh	FL18650-CF28	\$149.00
ToughBook CF-29, CF-51	11.1 Volt / 6750 mAh	FL18650-CF29	\$159.00

**PANASONIC ... continued from previous page**

ToughBook CF-37, CF-72, CF-72N, CF-72Q, CF-72T, CF-72V, CF-72X	11.1 Volt / 3000 mAh	FBATCF372	\$169.00
ToughBook CF-45, CF-V45	10.8 Volt / 3600 mAh	FL18650-6CF	\$219.00
ToughBook CF-VZSU22	7.4 Volt / 1700 mAh	PDA56	\$35.00

**PHILIPS**

433532790010, Nino 300, 301, 312, 320, 325, Nino Palm	2.4 Volt / 1500 mAh	PDA110	\$35.00
A-RBP001-WW, RBP001, Velo 500 Series	2.4 Volt / 1500 mAh	PDA111	\$35.00

**Q-TEK**

7070, 8060	3.7 Volt / 950 mAh	PDA105	\$38.00
8010, 8020, 8300, 8310	3.7 Volt / 1050 mAh	PDA107	\$22.00
9090	3.7 Volt / 1500 mAh	PDA132	\$52.00

**QUALCOMM**

6035, BQ6035L, Q6035, QCP-6035, QUA6035 (Li-Ion)	3.7 Volt / 1500 mAh	PDA15	\$38.00
--	---------------------	-------	---------

**RCA**

Lyra Jukebox RD2780A	3.7 Volt / 2200 mAh	PDA71	\$38.00
----------------------	---------------------	-------	---------

**SAGER**

NB2160, NP6200, NP6200AT, NP7400, PC-M200 (Li-Ion)	11.1 Volt / 6000 mAh	FDR202/DR202i	\$119.00
NB8600, NP6100T, NP6200, NP6200AT, NP660, NP8100, NP8300, NP8320, NP8600, NP8620, NP8623, NP862, NP980, PC-M200	12.0 Volt / 3800 mAh	FDR36AAS	\$149.00
NP660, NP8700 (Li-Ion)	11.1 Volt / 6000 mAh	FDR202/DR202i	\$119.00

**SAMSUNG**

BST134ASE	3.7 Volt / 1200 mAh	PDA83	\$55.00
i500	3.6 Volt / 1400 mAh	PDA92	\$20.00
Nexio S160, SSB-160ELP	3.7 Volt / 1800 mAh	PDA75	\$55.00
SENSpro 500 Series, 522, 523, 524, 525 (NiMH)	12.0 Volt / 3800 mAh	FDR36AAS	\$149.00
SPH-i700	3.7 Volt / 1000 mAh	PDA84	\$113.00

**SCEPTRE TECH.**

SoundX 6600, 6900, S6600, S6900, Series, TS30W (Li-Ion)	11.1 Volt / 4800 mAh	F2127U	\$189.00
SoundX S6500 Series, S6800 Series (Li-Ion)	14.4 Volt / 5400 mAh	F2941E	\$209.00

**SHARP**

EA-BL06, Zaurus L-5000, Zaurus SL-5000, SL-5000D, SL-5500, SL5500G, SL-C5000, SL-C700, SL-C750	3.7 Volt / 1100 mAh	PDA64	\$32.00
EA-BL08, Zaurus SL-5600	3.7 Volt / 1600 mAh	PDA66	\$46.00
EA-BL11, Zaurus C1000, C3000, C3100, SL-C1000, SL-C3000, SL-C3100	3.7 Volt / 2000 mAh	PDA137	\$95.00
PC-M100, PC-M200 (Li-Ion)	11.1 Volt / 6000 mAh	FDR202/DR202i	\$119.00

**SIEMENS**

SX66	3.7 Volt / 1500 mAh	PDA132	\$52.00
------	---------------------	--------	---------

**SONY**

Clie NZ, NZ90, PEGA-BP500	3.7 Volt / 1000 mAh	PDA30	\$42.00
---------------------------	---------------------	-------	---------

<b>SONY ... continued from previous page</b>			
Clie PEG-65, 66, T415, T615C/S, T665, T665C, LIS1228, UP503048	3.7 Volt / 700 mAh	PDA21	\$21.00
Clie PEG-N610C, N710C, N760C, UP503579-N760, UP503759-A4H	3.7 Volt / 1100 mAh	PDA23	\$35.00
Clie PEG-NX60, CLIE PEG-NR70, NR70VL, NX70VL, NX80, NR90, SJ33	3.7 Volt / 1300 mAh	PDA20	\$30.00
Clie PEG-S360, LIS1161	3.7 Volt / 800 mAh	PDA39	\$27.00
Clie PEG-SJ20, CLIE PEG-SJ30, CLIE PEG SL10, LIS1259, SJ22	3.7 Volt / 800 mAh	PDA8	\$21.00
Clie S300, S500C	3.7 Volt / 800 mAh	PDA31	\$27.00
Clie S700	3.6 Volt / 650 mAh	PDA98	\$15.00
Clie TJ25	3.7 Volt / 1800 mAh	PDA32	\$25.00
Clie UX40, UX50, PEGA-EB40, UP5530	5.2 Volt / 1000 mAh	PDA41	\$27.00
VAIO 700, 705, 707, 717, 719, 729, 731, 735, 748, 800, 808, 812, 818, 838, 9251, 9401, 955, 955A, 962, 964 Series, VAIO F, FX, FXA, SX, XF, XG Series, PCG-F, PCG-FX, PCG-FXA, PCG-XF, PCG-XG Series	14.8 Volt / 3000 mAh	FL17670-8SVF	\$139.00
VAIO AR, C, CR, FE, FJ, FS, FT, N, S, SZ Series, VGN-AR, VGN-C, VGN-CR, VGN-FE, VGN-FJ, VGN-FS, VGN-FT, VGN-N, VGN-S, VGN-SZ Series	11.1 Volt / 4500 mAh	FVGP-BPS2A	\$149.00
VAIO FR, FRV, GRS, GRT, GRV, GRX, GRZ, K, NV Series, PCG-FR, PCG-GRS, PCG-GRT, PCG-GRX, PCG-GRZ, PCG-K, PCG-NV Series	14.4 Volt / 4000 mAh	FL18650-8SGRX	\$139.00
VAIO R505 Super Slim Series, PCG-R505 Series	14.8 Volt / 2600 mAh	FL18500-8SSV	\$149.00

<b>SPRINT</b>			
Treo 600	3.7 Volt / 1700 mAh	PDA78	\$38.00

<b>SYMBOL</b>			
1UF103450, 20-36098-01, PPT2700, PPT2800, PPT2830, PPT2840, SPT1700, SPT1740, SPT1800, SPT270	3.7 Volt / 1650 mAh	PDA62	\$52.00

<b>T-MOBILE</b>			
02 XDA, 35H10008-80, MDA, Pocket PC Phone Edition, UP385385	3.7 Volt / 1500 mAh	PDA48	\$38.00
BTR5600B, CPB-35H00044-00, HTC098306, MDA50008, SDA, SDA Music, SDS Music, SMT5600, ST26A, ST26B, XDA0201	3.7 Volt / 1050 mAh	PDA107	\$22.00
MDAIII	3.7 Volt / 1500 mAh	PDA132	\$52.00

<b>TOSHIBA</b>			
DynaBook AX, CX, TX Series, DynaBook Satellite AW4, Equium A100, A110, M50 (PSM59E), M70 Series, Satellite Pro A100, A105, A110, A135, A80, A85, M50, M70 Series	10.8 Volt / 4800 mAh	FPA3465U-1BRS	\$124.00
DynaBook E5, E6 Series, Satellite 1100-Z, 1105-Z Series	9.6 Volt / 4500 mAh	FPA3210U-1BRS	\$119.00
DynaBook GTR590, Satellite Pro 400, 2100, 4200, 4300, 4600 Series, Satellite 200, 300, 400, 1040, 1400, 1500, 1800, 2000, 2100, 2200, 2400, 2500, 2600, 2700, 2800, 4000, 4100, 4200, 4300, 4400, 4600, 4700, 4900 Series, Small Business 1400, 2400 Series	10.8 Volt / 4500 mAh	FL17670-9TSP	\$129.00
E310, E330, E335, LAB503759C	3.7 Volt / 1100 mAh	PDA22	\$33.00
E400, UP324467-A6H, UP423467	3.7 Volt / 1000 mAh	PDA57	\$47.00
E740, E750, PA3187U-1BRS	3.7 Volt / 1000 mAh	PDA43	\$38.00
E800, E805, GC3450BSA00, PA3330U-1BRS	3.7 Volt / 1320 mAh	PDA50	\$42.00
Equium A60 Series, Satellite Pro A60 Series, Satellite A60, A65 Series	14.8 Volt / 4300 mAh	FPA3384U-1BRS	\$104.00
Equium A80, M100, M50 (PSM57E) Series, Satellite A80, M100, M40, M55 Series, Tecra A3, A4, A5, A6, A7 S2 Series	10.8 Volt / 4800 mAh	FPA3399U-1BRS	\$124.00

**TOSHIBA ... continued from previous page**

Equium M40X Series, Satellite M30X, M35X, M40X, M45 Series	14.8 Volt / 4300 mAh	FPA3395U-1BRS	\$139.00
Portege 650, 650CT, 660CDT, 660CT Series	10.8 Volt / 3400 mAh	FPA2492UR	\$129.00
Portege M200, M205, M400, M405 Series, Satellite Pro 6000, 6100 Series, Satellite R10, R15 Series, Small Business 6000, 6100 Series, Tecra M7, TE2000, TE2100 Series	10.8 Volt / 3800 mAh	FPA3128U-1BRS	\$109.00
Portege M300, S100 Series, Qosmio F20, F25 Series, Satellite A50, A55, U200, U205 Series, Tecra A2, A3X, M2, M2V, M3, M4, M5, M6, S3, S4 Series	10.8 Volt / 4400 mAh	FPA3356U-1BRS	\$119.00
Qosmio E10, E15, F15, G15, G20, G25 Series, Satellite Pro A120 Series, Satellite A10, A100, A15 Series, Small Business A10, A10-S100 Series, Tecra A1, A8	10.8 Volt / 4400 mAh	FPA3285U-1BRS	\$119.00
Satellite Pro A40 Series, Satellite A20, A25, A40, A45 Series	10.8 Volt / 8400 mAh	FPA3287U-1BRS	\$139.00
Satellite 1000, 1005 Series	9.6 Volt / 4000 mAh	FH400AE-8TS	\$119.00
Satellite 1600 Series	10.8 Volt / 3800 mAh	FH380AE-9TS	\$109.00
Satellite Pro T2155 Series, Satellite 100, 200, T2100 Series	12.0 Volt / 3800 mAh	FH240AE-T21	\$99.00
Tecra 8000 Series	10.8 Volt / 3750 mAh	FL17670-T8000	\$179.00
Tecra 8100 Series	10.8 Volt / 4500 mAh	FPA3009U-1BAR	\$179.00
Tecra 8200 Series	10.8 Volt / 3600 mAh	FL18650-T8200	\$159.00
Tecra S1 Series	10.8 Volt / 6450 mAh	FPA3257U-1BRS	\$139.00

**WINBOOK**

N4 Series	14.8 Volt / 3900 mAh	FIG222	\$149.00
XL, Xli Series	10.8 Volt / 3800 mAh	FH240AE-9WXL	\$139.00
XP, XP5, XP75 Series	12 Volt / 3800 mAh	FH240AE-10WB	\$119.00
Z, Z1 Series	11.1 Volt / 4800 mAh	F2127U	\$189.00

**CHLORIDE**

100-001-050, 100-001-079, 100-001-A128	6 Volt / 36 Ah	5988-F2	\$80.00
100-001-073, 100-001-135	6 Volt / 9.0 Ah	5966	\$17.50
100-001-074	6 Volt / 12.0 Ah	5377	\$22.00
100-001-075, 100-001-131, 100-001-145, 100-001-145	6 Volt / 4.5 Ah	1374	\$14.00
100-001-078, 100-001-136/137/149, 100-001-137, 100-001-149	6 Volt / 13.5 Ah	1380	\$20.00
100-001-132	2 Volt / 5.0 Ah	0800-0004	\$9.85
100-001-134, 100-001-164	6 Volt / 7.0 Ah	1375	\$14.00
100-001-144	12 Volt / 40.0 Ah	5545	\$125.00
100-001-161 (EnerSys Version)	4 Volt / 5.0 Ah	0809-0010	\$20.00
100-001-161 (Powersonic Version)	4 Volt / 4.5 Ah	5671	\$15.00
100-001-162	6 Volt / 8.0 Ah	0859-0012	\$36.30
100-001-A123	6 Volt / 5.0 Ah	0800-0103	\$45.50
100-003-0019, 100-003-A128	3.6 Volt / 5.0 Ah	5826-I	\$35.00
100-003-0043, 100-003-A051	2.4 Volt / 1.8 Ah	6098	\$15.00
100-003-A031	2.4 Volt / 4.2 Ah	6119	\$30.00
100-003-A032	2.4 Volt / 7.2 Ah	6126	\$60.00
100-003-A034	4.8 Volt / .70 Ah	5472	\$12.50
100-003-A036	4.8 Volt / .70 Ah	5872	\$14.00
100-003-A045	6 Volt / 4.3 Ah	5352	\$57.00
100-003-A047	2.4 Volt / 1.8 Ah	6127	\$15.00
100-003-A082	2.4 Volt / .70 Ah	6123	\$12.00
100-003-A091, 100-003-A093/A095/A097, 100-003-A095, 100-003-A097	2.4 Volt / .70 Ah	5001	\$6.95
100-003-A098 (Save Original Connector)	3.6 Volt / .70 Ah	6152	\$10.00

**DUAL LITE**

0120822E	2.4 Volt / .70 Ah	5001-A	\$9.00
12-255, 12-295, BDG, CLA-106	6 Volt / 4.5 Ah	1374	\$14.00
12-261, 12-542	2 Volt / 2.5 Ah	0810-0004	\$7.25
12-267, 12-269, 12-531	6 Volt / 5.0 Ah	0800-0103	\$45.50
12-268, 12-533, 12-534, 12-631	6 Volt / 13.5 Ah	1380	\$20.00
12-273	6 Volt / 12.0 Ah	5377	\$22.00
12-293	6 Volt / 20.0 Ah	5378	\$50.00
12-535	6 Volt / 9.0 Ah	5966	\$17.50
12-544	2 Volt / 5.0 Ah	0800-0004	\$9.85
12-546, 12-567	6 Volt / 6.5 Ah	PS-665	\$16.00
12-554, 12-568, 12-702	6 Volt / 36 Ah	5988-F2	\$80.00
12-561, 12-824, EZ-1A, EZ-2, GMM-EL-2	6 Volt / 7.0 Ah	1375	\$14.00
12-580, 12-609	4 Volt / 10.0 Ah	PS-4100	\$26.95
12-581, 12-693	4 Volt / 4.5 Ah	5671	\$15.00
12-582, 12-896	12 Volt / 18.0 Ah	1391	\$65.00
12-621, 12-803, 12-879	12 Volt / 8.5 Ah	1390	\$33.00
12-691 (Requires 2/unit)	6 Volt / 36 Ah	5988-F2	\$80.00
12-704, 12-770	4 Volt / 5.0 Ah	0809-0010	\$20.00
12-705	4 Volt / 8.0 Ah	0859-0010	\$30.80
12-706, 12-793	6 Volt / 5.0 Ah	0809-0012	\$33.00
12-707, 12-862	6 Volt / 8.0 Ah	0859-0012	\$36.30
12-708	6 Volt / 2.5 Ah	0819-0012	\$20.00
12-713, 12-760, 12-906	12 Volt / 33.0 Ah	1395	\$85.00
12-715	6 Volt / 1.8 Ah	5202	\$27.00
12-723, 12-727, 12-800, 12-825	6 Volt / 13.5 Ah	1380	\$20.00
12-728 (3 Battery Set)	6 Volt / 13.5 Ah	3614	\$60.00
12-731, 12-866, 12-895	12 Volt / 24.0 Ah	1393	\$70.00
12-737, 12-871, 12-910	12 Volt / 100 Ah	5987	\$215.00

**DUAL LITE ... continued from previous page**

12-749 (Requires 3/unit)	6 Volt / 8.0 Ah	0859-0012	\$36.30
12-752, 12-807, 12-809 (Requires 2/unit)	6 Volt / 8.0 Ah	0859-0012	\$36.30
12-759, 12-907	12 Volt / 55.0 Ah	6274	\$125.00
12-770	4 Volt / 5.0 Ah	0809-0010	\$20.00
12-771	6 Volt / 1.8 Ah	5296	\$27.00
12-790	4.8 Volt / .70 Ah	5150-A	\$12.00
12-804, 12-805, 12-828, 12-829, 12-830,12-832, 12-864, 12-865	6 Volt / 13.5 Ah	2380	\$40.00
12-806, 12-808	6 Volt / 5.0 Ah	0809-0012	\$33.00
12-822	2.4 Volt / .70 Ah	5001	\$6.95
12-826, 12-897 (2 Battery Set)	6 Volt / 7.0 Ah	2375	\$28.00
12-859	4.8 Volt / .70 Ah	5872	\$14.00
12-870, 12-909	12 Volt / 72.0 Ah	12HX300FR	\$164.62
12-894	4.8 Volt / .70 Ah	5472	\$12.50
12-908	12 Volt / 75.0 Ah	1901	\$175.00
12-922	6 Volt / 3.0 Ah	5371	\$15.00
DL-4, ML-2CH, ML-4 (2 Battery Set)	6 Volt / 7.0 Ah	2375	\$28.00
EDS, EDP, ERS, ECL-1, RLP, SDG	6 Volt / 7.0 Ah	1375	\$14.00
ML-2-12NY, ML-4S, ML-5S-12V (2 Battery Set)	6 Volt / 7.0 Ah	2375	\$28.00

**DYNARAY**

504, 749/7S	6 Volt / 13.5 Ah	1614	\$20.00
520	6 Volt / 4.5 Ah	1374	\$14.00
550-2, 556, 566, 586, 737/5SG, 739-5SG, 2200	6 Volt / 7.0 Ah	1375	\$14.00
707/14S, 749/14S (2 Battery Set)	6 Volt / 13.5 Ah	2380	\$40.00

**EDWARDS**

1600, 1624, 1637, 1667, 1660, 1660B	6 Volt / 4.5 Ah	1374	\$14.00
1602, 1620, 1627, 1631	6 Volt / 13.5 Ah	1614	\$20.00
1604, 1621, 1628, 1632 (2 Battery Set)	6 Volt / 13.5 Ah	2380	\$40.00
1611 (2 Battery Set)	6 Volt / 13.5 Ah	2380	\$40.00
1661, 1661B, 1662, 1662B, 1663, 1663B	6 Volt / 4.5 Ah	1374	\$14.00

**EMERGILITE (KAUFEL)**

12E13 (Requires 2/unit)	6 Volt / 8.0 Ah	0859-0012	\$36.30
12M12, 24M12 (Requires 4/unit)	6 Volt / 36 Ah	5988-F2	\$80.00
12M3	6 Volt / 9.0 Ah	5966	\$17.50
12M8 (8 Battery Set)	6 Volt / 13.5 Ah	8614	\$160.00
6E11,	6 Volt / 8.0 Ah	0859-0012	\$36.30
6E3, 12E3 (Requires 2/unit)	6 Volt / 5.0 Ah	0809-0012	\$33.00
6E4 (Requires 3/unit)	6 Volt / 5.0 Ah	0809-0012	\$33.00
6M11, 12M5, 12M11 (Requires 2/unit)	6 Volt / 36 Ah	5988-F2	\$80.00
6M4CS, 12M4, CSM36, ISLM36, JSM36,RSM36, 12CSM36-2, 12DSM36, 12ILSM36,12JSM9, 12JSM36 (2 Battery Set)	6 Volt / 13.5 Ah	2380	\$40.00
6M4 (Requires 2/unit)	6 Volt / 12.0 Ah	5377	\$22.00
6M5 (Requires 3/unit)	6 Volt / 36 Ah	5988-F2	\$80.00
6M6, 12M6, 24M6 (Requires 4/unit)	6 Volt / 12.0 Ah	5377	\$22.00
6M6G, 12M6G, 24M6G (4 Battery Set)	6 Volt / 13.5 Ah	4614	\$80.00
6M7 (Requires 6/unit)	6 Volt / 12.0 Ah	5377	\$22.00
6M9, 12M9 (2 Battery Set)	6 Volt / 7.0 Ah	2375	\$28.00
C1	6 Volt / 2.4 Ah	20B	\$16.00
C8	6 Volt / 1.8 Ah	5296	\$27.00
E2	6 Volt / 5.0 Ah	0800-0103	\$45.50
LEDSNX32R	6 Volt / 1.25 Ah	6079	\$28.00



**EMERGILITE (KAUFEL) ... continued from previous page**

M10, 6M10	6 Volt / 36 Ah	5988-F2	\$80.00
M17, 12M16	12 Volt / 33.0 Ah	1395	\$85.00
M18	4 Volt / 10.0 Ah	PS-4100	\$26.95
M19	4 Volt / 4.5 Ah	5671	\$15.00
M1, M9, CSM9, JSM9, PSM9, SMX	6 Volt / 4.5 Ah	1374	\$14.00
M2, 6M2, DSM18, ILSM18, JSM14, JSM18, LSM18, ME4, RSM18, SAX	6 Volt / 7.0 Ah	1375	\$14.00
M3, 6M3, CSM2, CSM8	6 Volt / 13.5 Ah	1380	\$20.00

**EXIDE / MULE**

4GC017H	4 Volt / 10.0 Ah	PS-4100	\$26.95
6GC025K, 6GC025J	6 Volt / 9.0 Ah	5966	\$17.50
6GC056N	6 Volt / 12.0 Ah	5377	\$22.00
6PL016G	6 Volt / 5.0 Ah	0800-0103	\$45.50
6V5, 6GC013F	6 Volt / 7.0 Ah	1375	\$14.00
6V5K (2 Battery Set)	6 Volt / 7.0 Ah	2375	\$28.00
6V6K	12 Volt / 8.5 Ah	1390	\$33.00
G120-12 (4 Battery Set)	6 Volt / 13.5 Ah	4380	\$80.00
M-400, S-300 (2 Battery Set)	6 Volt / 4.5 Ah	2374	\$28.00
MG-2 (Requires 2/unit)	6 Volt / 9.0 Ah	5966	\$17.50
MG-9, 6V10K, G60-6, G120-6, G60-12, Q-100, Q-101, Q-102, Q-103, QD-2, QD-3, QG2, 2002 (2 Battery Set)	6 Volt / 13.5 Ah	2380	\$40.00
NP-38	12 Volt / 40.0 Ah	5545	\$125.00
Q-4, Q-5, Q-6, 6V6, 6GC012D, 6GC012E, E-Exit, M-100, M-126, PB-100, S-100, SSG	6 Volt / 4.5 Ah	1374	\$14.00
Q-9, 6V10, 6GC028L, CPS, GLC, M-200, M-201, M-300, M-400, NX-100, PB-200, PW	6 Volt / 13.5 Ah	1380	\$20.00

**HOLOPHANE**

E110, M10, M11, M16 (4 Battery Set)	6 Volt / 13.5 Ah	4380	\$80.00
E1, EH6, E112, EC6, M3, M6, M8	6 Volt / 13.5 Ah	1614	\$20.00
EC12, EH12, M12, M13, M14, M15, M229 (2/set)	6 Volt / 13.5 Ah	2380	\$40.00
G60-6, G120-6, 2002, M2	12 Volt / 8.5 Ah	1390	\$33.00
M23, M32, M33, M73 (2 Battery Set)	6 Volt / 13.5 Ah	2380	\$40.00

**LIGHT ALARMS**

CE1-5AA, CE1-5BF, CE1-5BL, CE1-5BL, CE1-5BN, CE1-5BS, DM3, DS3, E8, FL, LL6, SGL-D, SQL	6 Volt / 4.5 Ah	1374	\$14.00
CE1-5AC, CE1-5AJ, CE1-5AR, CE1-5AT, CE1-5BB, CE1-5BR, AG1D	6 Volt / 13.5 Ah	1380	\$20.00
CE1-5AE, CE1-5BA (Requires 2/unit)	6 Volt / 9.0 Ah	5966	\$17.50
CE1-5AG, CE1-5AM, CE1-5BD, CE1-5BJ	6 Volt / 36 Ah	5988-F2	\$80.00
CE1-5AK, PG2 (2 Battery Set)	6 Volt / 13.5 Ah	2380	\$40.00
CE1-5AL	6 Volt / 9.0 Ah	5966	\$17.50
CE1-5AU	6 Volt / 6.5 Ah	PS-665	\$16.00
CE1-5BQ	6 Volt / 7.0 Ah	1375	\$14.00
CE1-5CA	12 Volt / 33.0 Ah	1395	\$85.00
CE1-5CB, CE1-5CK	12 Volt / 18.0 Ah	1391	\$65.00
CE1-6AJ, CE1A-6AB	6 Volt / 5.0 Ah	0800-0103	\$45.50
CE1-7AT	6 Volt / 4.3 Ah	5352	\$57.00

**LITHONIA**

ELB-0408, ELB-0410	4 Volt / 10.0 Ah	PS-4100	\$26.95
ELB-0501N, ELB-4814N	4.8 Volt / 1.8 Ah	5017	\$21.00
ELB-0502N	4.8 Volt / 1.8 Ah	5411	\$19.00
ELB-06010	6 Volt / 12.0 Ah	5614	\$27.00
ELB-0601N	6 Volt / 1.8 Ah	6241	\$27.00
ELB-0602N	6 Volt / 2.2 Ah	6133	\$18.00
ELB-0604	6 Volt / 4.5 Ah	5881	\$16.00
ELB-0604, ELB0605, ELM2, LL-LC-BE-2	6 Volt / 4.5 Ah	1374	\$14.00
ELB0604N	6 Volt / 4.5 Ah	6423	\$50.00
ELB0604N	6 Volt / 4.5 Ah	6423	\$50.00
ELB-0607	6 Volt / 7.0 Ah	5375-F2	\$16.00
ELB-0608, ES/EP-EL, LL-BE-1	6 Volt / 7.0 Ah	1375	\$14.00
ELB-0609, ELB-0612, ELB-0614	6 Volt / 10.0 Ah	5380	\$18.00
ELB-0609, ELB-0612, ELB-0614	6 Volt / 12.0 Ah	5377	\$22.00
ELB-0612A	6 Volt / 13.5 Ah	2614	\$40.00
ELB-0618 (Requires 2/unit)	6 Volt / 12.0 Ah	5377	\$22.00
ELB-0636	6 Volt / 36 Ah	5988-F2	\$80.00
ELB-0701N	7.2 Volt / 1.8 Ah	5294-I	\$45.00
ELB-1201N, ELB-1210N (NiCd)	1.2 Volt / 1.2 Ah	KR1200AUL	\$3.50
ELB-1207	12 Volt / 8.5 Ah	1390	\$33.00
ELB-1207N	12.0 Volt / 7.0 Ah	6323	\$185.00
ELB-12100	12 Volt / 100 Ah	5987	\$215.00
ELB1220	12 Volt / 18.0 Ah	1391	\$65.00
ELB-1228	12 Volt / 33.0 Ah	1395	\$85.00
ELB-1238	12 Volt / 40.0 Ah	5545	\$125.00
ELB-1250	12 Volt / 55.0 Ah	6274	\$125.00
ELB-1255	12 Volt / 75.0 Ah	1901	\$175.00
ELB-1P201N (NiCd)	1.2 Volt / 1.2 Ah	KR1200AUL-WL	\$4.00
ELB-2P401N (NiCd) (Requires 2/unit)	1.2 Volt / 1.2 Ah	KR1200AUL-WL	\$4.00
ELB-3641N (Save Original Wire Harness)	3.6 Volt / 4.5 Ah	6122	\$37.00
ELB-4865N	4.8 Volt / .70 Ah	5150-B	\$12.00
ELB-610, ELB-0610	6 Volt / 13.5 Ah	1380	\$20.00
LL-PL-BE-3	6 Volt / 5.0 Ah	0800-0103	\$45.50

**PRESCOLITE**

12-267	6 Volt / 5.0 Ah	0800-0103	\$45.50
12-704	4 Volt / 5.0 Ah	0809-0010	\$20.00
12-705	4 Volt / 8.0 Ah	0859-0010	\$30.80
12-706, 12-793	6 Volt / 5.0 Ah	0809-0012	\$33.00
12-707	6 Volt / 8.0 Ah	0859-0012	\$36.30
12-752 (Requires 2/unit)	6 Volt / 8.0 Ah	0859-0012	\$36.30
12-759	12 Volt / 55.0 Ah	6274	\$125.00
12-790	4.8 Volt / .70 Ah	5150	\$12.00
12-803	12 Volt / 8.5 Ah	1390	\$33.00
12-822, 0120822	2.4 Volt / .70 Ah	5001	\$6.95
12-826 (2 Battery Set)	6 Volt / 7.0 Ah	2375	\$28.00
12-859	4.8 Volt / .70 Ah	5872	\$14.00
12-894, 0120894	4.8 Volt / .70 Ah	5472	\$12.50
12-896	12 Volt / 18.0 Ah	1391	\$65.00
C20189101	2.4 Volt / 4.3 Ah	5006	\$21.50
E17400100, 12-866, 12-895	12 Volt / 24.0 Ah	1393	\$70.00
E26770100	4.8 Volt / .70 Ah	5472	\$12.50
E82082500	4.8 Volt / 1.8 Ah	5017	\$21.00
EMB-0600	6.0 Volt / .70 Ah	6056	\$20.00

**PRESCOLITE ... continued from previous page**

EMB-0606	6 Volt / 7.0 Ah	5375-F2	\$16.00
ENB-06006, E18750100, E82082100	7.2 Volt / .65 Ah	5700	\$12.85
ENB-0604, E16570100	6 Volt / 4.5 Ah	5352-A	\$57.00
ENB-0612	6 Volt / 1.8 Ah	5202	\$27.00
ERB-0604, E81914000, 12-255	6 Volt / 4.5 Ah	1374	\$14.00
ERB-0606, E81916500, E82080100, 12-824	6 Volt / 7.0 Ah	1375	\$14.00
ERB-0610, E81911000, 12-268, 12-631,12-800, 12-825	6 Volt / 13.5 Ah	1380	\$20.00
ERB-0620, ERB-1210, 12-828, 12-829,12-830, 12-832, 12-864, 12-865 (2 Battery Set)	6 Volt / 13.5 Ah	2380	\$40.00
ERB-0630, 12-554, 12-702	6 Volt / 36 Ah	5988-F2	\$80.00
ERB-1224 (4 Battery Set)	6 Volt / 13.5 Ah	4380	\$80.00

**SIGNTEX, INC.**

MLW Series (206129)	4.8 Volt / 5.0 Ah	6413	\$42.00
---------------------	-------------------	------	---------

**SIMPLEX**

112047, 20819276, 40208, 429115, STR112053	12 Volt / 33.0 Ah	1395	\$85.00
112-113, STR112113, 20819274	12 Volt / 12.0 Ah	1551	\$45.00
20013072	6 Volt / 13.5 Ah	1380	\$20.00
20819271, 2001, CF12V33L	12 Volt / 36.0 Ah	5995L	\$162.00
20819272, 20819288, 2350, 4002, STR112112	12 Volt / 8.5 Ah	1390	\$33.00
20819275, 112-046, 12V18AH, 92680	12 Volt / 18.0 Ah	1391	\$65.00
20819287	12 Volt / 26.0 Ah	5648	\$67.00
20819296	12 Volt / 24.0 Ah	1393	\$70.00
8000047, 630	12 Volt / 2.5 Ah	5170	\$52.50

**SURE LITES**

23-69, 26-3, 26-03, 26-50, 26-54, 26-56,EP2H, GPS, P4C1, RD-3, UMB-4	6 Volt / 13.5 Ah	1380	\$20.00
26-01, 23-03, 26-04	6 Volt / 9.0 Ah	5966	\$17.50
26-10	6 Volt / 12.0 Ah	5377	\$22.00
26-11	12 Volt / 18.0 Ah	1391	\$65.00
26-119	6 Volt / 5.0 Ah	0809-0012	\$33.00
26-120	6 Volt / 8.0 Ah	0859-0012	\$36.30
26-13	6 Volt / 5.0 Ah	0800-0103	\$45.50
26-139	6 Volt / 1.8 Ah	5202	\$27.00
26-144	6 Volt / 4.3 Ah	5352	\$57.00
26-148	3.6 Volt / .70 Ah	6124	\$12.00
26-150	3.6 Volt / .70 Ah	5180	\$10.00
26-155	4.8 Volt / .70 Ah	5472	\$12.50
26-18, 26-132	6 Volt / 36 Ah	5988-F2	\$80.00
26-2, 26-02, 26-78, 26-117, 12-12, CA, DCE,EP, LM1, MPS640SP, RLM1, SLC1, UN, 8031	6 Volt / 4.5 Ah	1374	\$14.00
26-25 (Requires 2/unit)	6 Volt / 36 Ah	5988-F2	\$80.00
26-45, 26-89, AA-1, RD-1	6 Volt / 7.0 Ah	1375	\$14.00
26-58	12 Volt / 8.5 Ah	1390	\$33.00
UBM-5, 4CH-1, 12SLHC (2 Battery Set)	6 Volt / 13.5 Ah	2380	\$40.00

**YORKLITE**

20, 2000	6 Volt / 12.0 Ah	5377	\$22.00
MQ2E1, M2E12, MX2E1, R2E22	6 Volt / 13.5 Ah	1380	\$20.00

**AEG**

ABS10, ABSE10, AL7, P7.2/A10	7.2 Volt / 1.5 Ah	T-3	\$37.00
ABS10, ABSE10, AL7, P7.2/A10	7.2 Volt / 2.5 Ah	T-4	\$62.00
ABS13, ABSE13, P9.6/A13, SE13	9.6 Volt / 1.5 Ah	T-5	\$43.00
ABS13, ABSE13, P9.6/A13, SE13	9.6 Volt / 2.5 Ah	T-6	\$77.00
ABS6, BS6, Powertac 14	2.4 Volt / 1.5 Ah	T-1	\$25.00
ABS6, BS6, Powertac 14	2.4 Volt / 2.5 Ah	T-2	\$33.00
B12	12 Volt / 1.5 Ah	T-7	\$51.00
B12	12 Volt / 2.5 Ah	T-8	\$97.00
BS2E 7.2T	7.2 Volt / 2.0 Ah	T-165	\$36.00
BS2E 9.6T	9.6 Volt / 2.0 Ah	T-166	\$36.00
P9.6	9.6 Volt / 2.0 Ah	T-216	\$60.00

**BLACK & DECKER**

PS120, PS3200, PS3300, PS3350K	9.6 Volt / 2.0 Ah	T-928	\$44.00
PS120, PS3200, PS3300, PS3350K	9.6 Volt / 1.5 Ah	T-927	\$34.00
PS130, PS3500, PS3500K	12 Volt / 2.0 Ah	T-9133	\$59.00
PS130, PS3500, PS3500K	12 Volt / 2.4 Ah	T-930	\$65.00
PS130, PS3500, PS3500K	12 Volt / 1.5 Ah	T-929	\$41.00
PS140, PS3600, PS3650K, PS3650K-2	14.4 Volt / 1.5 Ah	T-931	\$46.00
PS140, PS3600, PS3650K, PS3650K-2	14.4 Volt / 2.0 Ah	T-932	\$61.00
PS145, PS3700, PS3750K-2	18 Volt / 1.5 Ah	T-933	\$53.00
PS145, PS3700, PS3750K-2	18 Volt / 2.4 Ah	T-934	\$88.00
PS145, PS3700, PS3750K-2	18 Volt / 2.0 Ah	T-9132	\$53.00

**BOSCH**

2 607 300 001, GBM7.2/BS6	7.2 Volt / 1.5 Ah	T-13	\$35.00
2 607 300 001, GBM7.2/BS6	7.2 Volt / 2.5 Ah	T-14	\$61.00
2 607 335 033, 2 607 335 153, GSR7.2ES-2, PSR7.2VES	7.2 Volt / 1.5 Ah	T-19	\$35.00
2 607 335 033, 2 607 335 153, GSR7.2ES-2, PSR7.2VES	7.2 Volt / 2.5 Ah	T-20	\$62.00
2 607 335 062, 929040	3.6 Volt / 2.5 Ah	T-10	\$33.00
2 607 335 062, 929040	3.6 Volt / 1.5 Ah	T-9	\$22.00
2 607 335 082, 2 607 335 216, BAT019, BAT020, BAT021, BAT030, GBH24VRE	24 Volt / 2.7 Ah	T-107	\$182.00
2 607 335 175, GWB7.2/7.2VE	7.2 Volt / 1.5 Ah	T-11	\$35.00
2 607 335 175, GWB7.2/7.2VE	7.2 Volt / 2.5 Ah	T-12	\$62.00
2 607 335 262, 2 607 335 274, 2 607 335 375, GSB12VE-2, GSR12VE-2, GSR12-1	12 Volt / 2.0 Ah	T-219	\$64.00
2 607 335 272, 2 607 335 273, 4 607 335 260, GSR9.6-1	9.6 Volt / 2.0 Ah	T-218	\$55.00
2 607 335 437, GSR7.2-1	7.2 Volt / 2.0 Ah	T-217	\$46.00
2 607 336 013, BAT114, PS10-2, PS20-2	10.8 Volt / 1.5 Ah	T-220	\$37.00
3 607 300 501	9.6 Volt / 2.0 Ah	T-167	\$49.00
BAT001, 2 607 335 037, 2 607 335 072, 2 607 335 152, 2 607 335 230, 2 607 335 254, GBM9.6VES-2	9.6 Volt / 1.5 Ah	T-21	\$51.00
BAT001, 2 607 335 037, 2 607 335 072, 2 607 335 152, 2 607 335 230, 2 607 335 254, GBM9.6VES-2	9.6 Volt / 2.5 Ah	T-22	\$75.00
BAT018	18 Volt / 1.5 Ah	T-168	\$62.00
BAT018	18 Volt / 2.0 Ah	T-169	\$78.00
BAT025/BAT026	18 Volt / 1.5 Ah	T-172	\$59.00
BAT025/BAT026	18 Volt / 2.0 Ah	T-173	\$86.00
BAT030/031 Platnum	24 Volt / 2.0 Ah	T-174	\$111.00
BAT030/031 Platnum	24 Volt / 3.3 Ah	T-175	\$136.00
BAT040	14.4 Volt / 1.5 Ah	T-170	\$46.00
BAT040	14.4 Volt / 2.0 Ah	T-171	\$59.00

**BOSCH ... continued from previous page**

BS-8, GBM9.6VE, GBB9.6VE	9.6 Volt / 2.5 Ah	T-16	\$77.00
BS-8, GBM9.6VE, GBB9.6VE	9.6 Volt / 1.5 Ah	T-15	\$41.00
GBH24VR	24 Volt / 1.5 Ah	T-25	\$85.00
GBH24VR	24 Volt / 2.5 Ah	T-26	\$153.00
GBM12VES-2, GSB12VSP-2, BAT011, GSR12VE-2, 2 607 335 055/071/051/081/244/250	12 Volt / 2.5 Ah	T-24	\$89.00
GBM12VES-2, GSB12VSP-2, BAT011, GSR12VE-2, 2 607 335 055/071/051/081/244/250	12 Volt / 1.5 Ah	T-23	\$48.00
GSB/GSR12	12 Volt / 1.5 Ah	T-17	\$49.00
GSB/GSR12	12 Volt / 2.5 Ah	T-18	\$94.00

**BURNDY**

BAT-35, Crimp Tool BAT-35	14.4 Volt / 2.5 Ah	T-69	\$96.00
---------------------------	--------------------	------	---------

**CRAFTSMAN**

11030	9.6 Volt / 2.0 Ah	T-177	\$44.00
11030	9.6 Volt / 1.5 Ah	T-176	\$36.00
11031	12 Volt / 2.0 Ah	T-179	\$50.00
11031	12 Volt / 1.5 Ah	T-178	\$50.00
11033	14.4 Volt / 2.0 Ah	T-181	\$55.00
11033	14.4 Volt / 1.5 Ah	T-180	\$43.00
11034	18 Volt / 1.5 Ah	T-182	\$50.00
11034	18 Volt / 2.0 Ah	T-183	\$76.00
11035	24 Volt / 2.0 Ah	T-185	\$80.00
11035	24 Volt / 1.5 Ah	T-184	\$60.00
11072/11094/11198	7.2 Volt / 2.0 Ah	T-187	\$40.00
11072/11094/11198	7.2 Volt / 1.5 Ah	T-186	\$30.00
11095/11147	13.2 Volt / 1.5 Ah	T-196	\$47.00
11095/11147	13.2 Volt / 1.5 Ah	T-195	\$47.00
11098/11305/11313	18 Volt / 2.0 Ah	T-201	\$72.00
11100/11343	9.6 Volt / 2.0 Ah	T-189	\$45.00
11100/11343	9.6 Volt / 1.5 Ah	T-188	\$33.00
11102	12 Volt / 1.5 Ah	T-191	\$44.00
11102	12 Volt / 2.0 Ah	T-192	\$57.00
11105	14.4 Volt / 1.5 Ah	T-197	\$47.00
11105	14.4 Volt / 2.0 Ah	T-198	\$65.00
11108, 11189, 27189	9.6 Volt / 2.0 Ah	T-222	\$57.00
11140/11415/11388	16.8 Volt / 1.7 Ah	T-199	\$64.00
11161	12 Volt / 1.5 Ah	T-193	\$43.00
11161	12 Volt / 2.0 Ah	T-194	\$56.00
1323903	19.2 Volt / 2.0 Ah	T-224	\$102.00
973572-002	6 Volt / 2.0 Ah	T-221	\$40.00
975172-001	15.6 Volt / 2.0 Ah	T-223	\$81.00
976965-002	9.6 Volt / 1.5 Ah	T-190	\$52.00

**DEWALT**

9061, Saft UL9619DW	9.6 Volt / 2.0 Ah	T-928	\$44.00
9062/PS120, Saft UL9619DW	9.6 Volt / 1.5 Ah	T-927	\$34.00
9072/PS130	12 Volt / 1.5 Ah	T-929	\$41.00
9091	14.4 Volt / 2.0 Ah	T-932	\$61.00
9094/PS140	14.4 Volt / 1.5 Ah	T-931	\$46.00
9096	18 Volt / 2.4 Ah	T-934	\$88.00
9098/PS145	18 Volt / 1.5 Ah	T-933	\$53.00

**DEWALT ... continued from previous page**

DW0242	24 Volt / 2.4 Ah	T-DW0242	\$195.00
DW9057	7.2 Volt / 2.1 Ah	T-DW9057	\$41.75
DW9071	12 Volt / 2.0 Ah	T-9133	\$59.00
DW9095	18 Volt / 2.0 Ah	T-9132	\$53.00
High Cap	12 Volt / 2.4 Ah	T-930	\$65.00

**DREMEL**

8000-01, 855	10.8 Volt / 1.5 Ah	T-225	\$51.00
--------------	--------------------	-------	---------

**FESTOOL**

BP12C, CDD12	12 Volt / 2.2 Ah	T-234	\$68.00
BP12T, BPH12T, TDD12	12 Volt / 2.0 Ah	T-227	\$68.00
BPH14.4T, TDD14.4	14.4 Volt / 2.0 Ah	T-228	\$89.00
BPH9.6C, CDD9.6	9.6 Volt / 2.2 Ah	T-233	\$61.00
BPH9.6T, TDD9.6	9.6 Volt / 2.0 Ah	T-226	\$56.00
BPS12, TDK12	12 Volt / 2.0 Ah	T-229	\$69.00
BPS12, TDK12	12 Volt / 3.0 Ah	T-230	\$89.00
BPS15.6, TDK15.6	15.6 Volt / 2.0 Ah	T-231	\$94.00
BPS15.6, TDK15.6	15.6 Volt / 3.0 Ah	T-232	\$120.00

**FLASHLIGHT BATTERIES**

15X	6 Volt / 1.8 Ah	15X	\$14.00
20B, SL20, SL20X, RX1019, ARXX075, 20170, 20X170, 9032, 19232RX1019, Maglight Magcharger, MA5, ML500, ML5000, N38AF001A	6 Volt / 3.5 Ah	20BMH	\$24.00
 20B, SL20, SL20X, RX1019, ARXX075, 20170, 20X170, 9032, 19232RX1019, Maglight Magcharger, MA5, ML500, ML5000, N38AF001A	6 Volt / 2.4 Ah	20B	\$16.00
20B, SL20, SL20X, RX1019, ARXX075 (Soft)	6 Volt / 2.4 Ah	SL20	\$24.00
20XP, 25170	6 Volt / 1.8 Ah	20XP	\$16.50
Charger for 20B and 20BMH	6 V Charger	FBC-NCD1	\$14.00
Charger for STR48 and STR48MH	3.6 V Charger	FBC-NCD4	\$16.00
Inova T4 (old style), T4 with reflector, UR611, T4 made before 2007, fits 2005 and 2006 models	3.7 Volt / 2.1 Ah	FLB-LIN-7	\$23.00
Litebox LED, 45630	12 Volt / 7.0 Ah	5390	\$25.00
Scorpion (Requires 2/unit)	3 Volt / 1.5 Ah	5517	\$5.25
SL20XP, SL15, 15X1701, 25170, 40070131, 405462100	6 Volt / 1.1 Ah	15B	\$22.00
SL35, SL35X	6 Volt / 4.3 Ah	35B	\$33.00
SL40, Fire Box, Lite Box, 40B, 45706	6 Volt / 10 Ah	40B	\$14.75
SL90X, Survivor Division II Bat, 90338, 90041, 90042, 90044, 90062, 90064, 90241, 90243, 90244, 90262, 90264	4.8 Volt / 1.8 Ah	FLB-NCD5	\$29.00
Stinger, HP, XP, LED, XT, PolyStiger, Pelican M9, 75175, 75375	3.6 Volt / 1.8 Ah	STR48	\$14.00
Stinger, HP, XP, LED, XT, PolyStiger, Pelican M9, 75175, 75375	3.6 Volt / 2.4 Ah	STR48MH	\$17.00

**FLASHLIGHT BATTERIES ... continued from previous page**

Streamlight Strion, Junior Luxeon, Inova T4-BO (T4's with serial numbers starting with B) 2007 or newer, 74000, 74001, 74002, 74004, 74011, 74012, 74013, 74021, 74022, 74023, 74031, 74032, 74033, 74175, 74201, 74202, 74203, 74204, 74205, 74206, 74300, 74301, 74302, 74304, 74311, 74312, 74313, 74321, 74322, 74323, 74331, 74332, 74333, 75300, 78540	3.7 Volt / 2.2 Ah	FLB-LIN-8	\$24.00
Super Stinger, Ultra Stinger, 77175, 9926J, SL20XP-LED, SL-20L, 77375, 20XP, 25170, 20XP, 25170	6 Volt / 1.8 Ah	STR20	\$18.00
Vulcan, 44007, Sho-Me	6 Volt / 4.5 Ah	5374	\$12.00

**HITACHI**

306132, EB7/G/S	7.2 Volt / 1.5 Ah	T-39	\$38.00
306132, EB7/G/S	7.2 Volt / 2.5 Ah	T-40	\$67.00
310453/EB12/S/M/EB1224/1230H	12 Volt / 1.5 Ah	T-43	\$53.00
310453/EB12/S/M/EB1224/1230H	12 Volt / 2.5 Ah	T-44	\$97.00
315129, EB14B, S, H EB1424/1430H	14.4 Volt / 2.5 Ah	T-111	\$117.00
315129, EB14B, S, H EB1424/1430H	14.4 Volt / 1.5 Ah	T-110	\$67.00
316965, EB24B, 2430H	24 Volt / 2.5 Ah	T-115	\$176.00
316965, EB24B, 2430H	24 Volt / 1.5 Ah	T-114	\$99.00
317327, EB1820, EB18B, 1830H	18 Volt / 1.5 Ah	T-112	\$77.00
317327, EB1820, EB18B, 1830H	18 Volt / 2.5 Ah	T-113	\$147.00
319807, EB2420, EB2430HA	24 Volt / 3.3 Ah	T-206	\$169.00
319807, EB2420, EB2430HA	24 Volt / 2.0 Ah	T-205	\$111.00
980579Z, B-2	7.2 Volt / 2.5 Ah	T-38	\$61.00
980579Z, B-2	7.2 Volt / 1.5 Ah	T-37	\$35.00
991664Z, EB9/B/S/924/930H	9.6 Volt / 2.5 Ah	T-42	\$78.00
991664Z, EB9/B/S/924/930H	9.6 Volt / 1.5 Ah	T-41	\$45.00
EB1220HS, EB1220BL	12 Volt / 2.2 Ah	T-235	\$77.00

**LINCOLN**

1201, 218-787, LNI-1201, LNI-1242, LNI-1244	12 Volt / 1.3 Ah	T-300	\$116.00
---	------------------	-------	----------

**MAKITA**

1200 (192271-4), 1201/1202, High Cap	12 Volt / 2.0 Ah	T-59	\$62.00
1200 (192271-4), 1201/1202, High Cap	12 Volt / 2.5 Ah	T-60	\$85.00
1200 (192271-4), 1201/1202, High Cap	12 Volt / 1.5 Ah	T-58	\$43.00
1210 (632277-5), High Cap	12 Volt / 2.5 Ah	T-54	\$86.00
1210 (632277-5), High Cap	12 Volt / 1.5 Ah	T-53	\$43.00
1220 (192681-5), 1222 (192598-2), 1233, 34, 35	12 Volt / 1.5 Ah	T-64	\$47.00
1220 (192681-5), 1222 (192598-2), 1233, 34, 35	12 Volt / 2.0 Ah	T-65	\$47.00
1220 (192681-5), 1222 (192598-2), 1233, 34, 35	12 Volt / 2.5 Ah	T-66	\$74.00
6010, High Cap	7.2 Volt / 1.5 Ah	T-45	\$29.00
6010, High Cap	7.2 Volt / 2.4 Ah	T-46	\$47.00
7000 (632002-4), 7002, 7033	7.2 Volt / 2.5 Ah	T-49	\$56.50
7000 (632002-4), 7002, 7033	7.2 Volt / 1.5 Ah	T-47	\$29.00
7000 (632002-4), 7002, 7033	7.2 Volt / 2.0 Ah	T-48	\$42.00
9000 (632007-4), 9002, 9033 (192696-2)	9.6 Volt / 2.5 Ah	T-52	\$67.00
9000 (632007-4), 9002, 9033 (192696-2)	9.6 Volt / 2.0 Ah	T-51	\$50.00
9000 (632007-4), 9002, 9033 (192696-2)	9.6 Volt / 1.5 Ah	T-50	\$32.00
9100 (192019-4), 9101/9102, High Cap	9.6 Volt / 2.5 Ah	T-57	\$70.00
9100 (192019-4), 9101/9102, High Cap	9.6 Volt / 2.0 Ah	T-56	\$51.00
9100 (192019-4), 9101/9102, High Cap	9.6 Volt / 1.5 Ah	T-55	\$37.00
9120 (192638-6), 9122 (192596-6), 9133, 34, 35	9.6 Volt / 2.5 Ah	T-63	\$73.00

**MAKITA ... continued from previous page**

9120 (192638-6), 9122 (192596-6), 9133, 34, 35	9.6 Volt / 2.0 Ah	T-62	\$54.00
9120 (192638-6), 9122 (192596-6), 9133, 34, 35	9.6 Volt / 1.5 Ah	T-61	\$39.00
B2417 (193737-7), B2430 (193131-3)	24 Volt / 2.6 Ah	T-210	\$114.00
B2417 (193737-7), B2430 (193131-3)	24 Volt / 3.3 Ah	T-211	\$189.00
B9017A	9.6 Volt / 3.3 Ah	T-207	\$98.00
BH1220, BH1233	12 Volt / 3.3 Ah	T-208	\$110.00
BH1420, BH1433	14.4 Volt / 2.6 Ah	T-209	\$105.00
Standard, 1422 (192600-1), 1433, 34, 35	14.4 Volt / 2.0 Ah	T-68	\$73.00
Standard, 1422 (192600-1), 1433, 34, 35	14.4 Volt / 2.5 Ah	T-69	\$96.00
Standard, 1422 (192600-1), 1433, 34, 35	14.4 Volt / 1.5 Ah	T-67	\$54.00
Standard, 1822, 1833, 1834, 1835	18 Volt / 2.5 Ah	T-72	\$118.00
Standard, 1822, 1833, 1834, 1835	18 Volt / 1.5 Ah	T-70	\$65.00
Standard, 1822, 1833, 1834, 1835	18 Volt / 2.0 Ah	T-71	\$89.00

**METABO**

6.25473, BSZ12, BSZ12 IMPULS, SSP12, ULA9.6-18	12 Volt / 2.2 Ah	T-237	\$77.00
6.25475, BSZ14.4, BSZ14.4 IMPULS	14.4 Volt / 2.2 Ah	T-238	\$94.00
6.31179, BEA25S-R+L, BEAT112/2S-R+L, BEAT12/2R+L, BHEA12S-R+L, BHEA14S-R+L, HLA15, HSA8043, SBEA112/2R+L	12 Volt / 2.4 Ah	T-236	\$89.00
ABE9.6	9.6 Volt / 1.5 Ah	T-75	\$41.00
ABE9.6	9.6 Volt / 2.5 Ah	T-76	\$77.00
BE AT7.2	7.2 Volt / 1.5 Ah	T-73	\$35.00
BE AT7.2	7.2 Volt / 2.5 Ah	T-74	\$62.00
BH EA12	12 Volt / 2.5 Ah	T-78	\$96.00
BH EA12	12 Volt / 1.5 Ah	T-77	\$49.00
BS18, BST18	18 Volt / 1.5 Ah	T-116	\$200.00
BS18, BST18	18 Volt / 2.4 Ah	T-117	\$200.00
BS/BST12	12 Volt / 2.5 Ah	T-82	\$91.00
BS/BST12	12 Volt / 1.5 Ah	T-81	\$48.00
BS/BST15.6+	15.6 Volt / 1.5 Ah	T-83	\$65.00
BS/BST15.6+	15.6 Volt / 2.5 Ah	T-84	\$125.00
BS/T9.6	9.6 Volt / 1.5 Ah	T-79	\$45.00
BS/T9.6	9.6 Volt / 2.5 Ah	T-80	\$83.00
BSZ18, BSZ18 IMPULS, KSAP18, ULA9.6-18	18 Volt / 2.2 Ah	T-239	\$112.00

**MILWAUKEE**

48-11-0080, High Cap, Super High Cap	9.6 Volt / 2.4 Ah	T-123	\$63.00
48-11-0080, High Cap, Super High Cap	9.6 Volt / 1.5 Ah	T-122	\$40.00
48-11-0080, High Cap, Super High Cap	9.6 Volt / 2.0 Ah	T-136	\$54.00
48-11-0100, High Cap, Super High Cap	2.4 Volt / 2.0 Ah	T-134	\$24.00
48-11-0100, High Cap, Super High Cap	2.4 Volt / 1.5 Ah	T-118	\$20.00
48-11-0100, High Cap, Super High Cap	2.4 Volt / 2.4 Ah	T-119	\$27.00
48-11-0130, High Cap, Super High Cap	7.2 Volt / 1.5 Ah	T-120	\$33.00
48-11-0130, High Cap, Super High Cap	7.2 Volt / 2.0 Ah	T-135	\$44.00
48-11-0130, High Cap, Super High Cap	7.2 Volt / 2.4 Ah	T-121	\$51.00
48-11-0140, 0200, 48-11-0250, 48-11-0300	12 Volt / 2.0 Ah	T-138	\$65.00
48-11-0140, 0200, 48-11-0250, 48-11-0300	12 Volt / 1.5 Ah	T-126	\$47.00
48-11-0140, 0200, 48-11-0250, 48-11-0300	12 Volt / 2.4 Ah	T-127	\$76.00
48-11-1000, High Cap, 48-11-1024	14.4 Volt / 1.5 Ah	T-128	\$53.00
48-11-1000, High Cap, 48-11-1024	14.4 Volt / 2.4 Ah	T-129	\$84.00
48-11-1000, High Cap, 48-11-1024	14.4 Volt / 2.0 Ah	T-139	\$75.00
48-11-1950, 48-11-1900, Super High Cap	12 Volt / 2.4 Ah	T-125	\$78.00



**MILWAUKEE ... continued from previous page**

48-11-1950, 48-11-1900, Super High Cap	12 Volt / 1.5 Ah	T-124	\$44.00
48-11-1950, 48-11-1900, Super High Cap	12 Volt / 2.0 Ah	T-137	\$63.00
MILWAUKEE: 48-11-0100	2.4 Volt / 2.4 Ah	T-119	\$27.00
Standard, 48-11-2100, 2101, Super High Cap	18 Volt / 1.5 Ah	T-130	\$65.00
Standard, 48-11-2100, 2101, Super High Cap	18 Volt / 2.0 Ah	T-140	\$92.00
Standard, 48-11-2100, 2101, Super High Cap	18 Volt / 2.4 Ah	T-131	\$109.00
Standard, 48-11-2200, 48-11-2230	18 Volt / 2.5 Ah	T-87	\$121.00
Standard, 48-11-2200, 48-11-2230	18 Volt / 1.5 Ah	T-85	\$69.00
Standard, 48-11-2200, 48-11-2230	18 Volt / 2.0 Ah	T-86	\$81.00

**PANASONIC**

COMBO KIT EYC151CQW, EYC155GQW, EYC485GQW, EY3544, EY3551GQ, EY3552GQW, EY3796B, EY6450GQKW, EY6950GQKW	18 Volt / 3.4 Ah	T-242	\$33.00
EY9001, 9006, 9101, 9103, 9106, 9107, 9108, 9200	12 Volt / 2.5 Ah	T-97	\$94.00
EY9001, 9006, 9101, 9103, 9106, 9107, 9108, 9200	12 Volt / 1.5 Ah	T-96	\$51.00
EY9025B	3.6 Volt / 1.5 Ah	T-90	\$25.00
EY9025B	3.6 Volt / 2.5 Ah	T-91	\$41.00
EY902, 9021, 903	2.4 Volt / 1.5 Ah	T-88	\$21.00
EY902, 9021, 903	2.4 Volt / 2.5 Ah	T-89	\$30.00
EY9065	7.2 Volt / 2.5 Ah	T-93	\$62.00
EY9065	7.2 Volt / 1.5 Ah	T-92	\$35.00
EY9117, 9210	24 Volt / 2.5 Ah	T-101	\$184.00
EY9117, 9210	24 Volt / 1.5 Ah	T-100	\$89.00
EY9136, 9230, 9137	15.6 Volt / 1.5 Ah	T-98	\$65.00
EY9136, 9230, 9137	15.6 Volt / 2.5 Ah	T-99	\$125.00
Long Stem, EY9080, 9080	9.6 Volt / 1.5 Ah	T-94	\$43.00
Long Stem, EY9080, 9080	9.6 Volt / 2.5 Ah	T-95	\$77.00
Short Stem, EY9182, 9086	9.6 Volt / 1.5 Ah	T-102	\$45.00
Short Stem, EY9182, 9086	9.6 Volt / 2.5 Ah	T-103	\$83.00

**PASLODE**

404400 / 404717	6 Volt / 1.5 Ah	T-212	\$42.00
Impulse 402500	6 Volt / 1.5 Ah	T-213	\$42.00

**PELICAN**

Stealthlite 2450 (2469)	4.8 Volt / 1.5 Ah	6328	\$12.00
-------------------------	-------------------	------	---------

**PORTER CABLE**

8623	12 Volt / 1.5 Ah	T-149	\$49.00
8623	12 Volt / 2.2 Ah	T-150	\$62.00
8723	14.4 Volt / 1.5 Ah	T-151	\$58.00
8723	14.4 Volt / 2.2 Ah	T-152	\$65.00
8823 Network	19.2 Volt / 1.5 Ah	T-153	\$74.00
8823 Network	19.2 Volt / 2.2 Ah	T-154	\$89.00

**RYOBI**

131145	7.2 Volt / 1.5 Ah	T-214	\$31.00
1400651	9.6 Volt / 1.5 Ah	T-157	\$38.00
1400651	9.6 Volt / 2.2 Ah	T-158	\$40.00
1400652	12 Volt / 1.5 Ah	T-159	\$45.00
1400652	12 Volt / 2.2 Ah	T-160	\$59.00

<b>RYOBI ... continued from previous page</b>			
1400668	7.2 Volt / 1.5 Ah	T-155	\$34.00
1400668	7.2 Volt / 2.2 Ah	T-156	\$42.00
1400671	14.4 Volt / 1.5 Ah	T-161	\$51.00
1400671	14.4 Volt / 2.2 Ah	T-162	\$67.00
1400672	18 Volt / 2.2 Ah	T-164	\$92.00
1400672	18 Volt / 1.5 Ah	T-163	\$66.00

<b>SKIL</b>			
120BAT	12 Volt / 1.5 Ah	T-147	\$38.00
120BAT	12 Volt / 2.2 Ah	T-148	\$50.00
2040, 2131, 2207, 2211, 2236, 2237, 2273, 2425, 92940, Cordless Flexi-Charge Battery	3.6 Volt / 1.5 Ah	T-9	\$22.00
2040, 2131, 2207, 2211, 2236, 2237, 2273, 2425, 92940, Cordless Flexi-Charge Battery	3.6 Volt / 2.5 Ah	T-10	\$33.00
92931, 92927	12 Volt / 2.2 Ah	T-146	\$64.00
92931, 92927	12 Volt / 1.5 Ah	T-145	\$50.00
92955	9.6 Volt / 1.5 Ah	T-141	\$38.00
92955	9.6 Volt / 2.2 Ah	T-142	\$50.00
S92975	12 Volt / 2.2 Ah	T-144	\$50.00
S92975	12 Volt / 1.5 Ah	T-143	\$40.00

Tool

**MOBILITY LIFT BATTERIES MFG/MODEL                      VOLTAGE/CAPACITY    R&D PART    LIST PRICE**

<b>21st CENTURY</b>			
All Other Models (Requires 2/unit)	12 Volt / 55.0 Ah	6274	\$125.00
Bounder, Big Bounder (Set of 2)	12 Volt / 75.0 Ah	2901	\$350.00

<b>A-BEC/SUNTECH</b>			
BEC 40 Series, Scoota Bug, Std Series, Targa 14", 16", 18" (Set of 2)	12 Volt / 33.0 Ah	2395	\$170.00

<b>ADAPTIVE DRIVING SYSTEMS</b>			
Model 12	12 Volt / 75.0 Ah	1901	\$175.00
Model 14 (Requires 2/unit)	12 Volt / 55.0 Ah	6274	\$125.00

<b>ADVANCED TECHNOLOGY</b>			
All Models	12 Volt / 75.0 Ah	1901	\$175.00

<b>ALPHA UNLIMITED</b>			
All Models (Set of 2)	12 Volt / 75.0 Ah	2901	\$350.00

<b>AMIGO</b>			
Amigo FD (Front Wheel Drive), Sport (Updated)	12 Volt / 33.0 Ah	1395	\$85.00
Amigo Fiesta, Amigo RT (Set of 2)	12 Volt / 18.0 Ah	2391	\$130.00
Amigo Fiesta IV, Grand Tour Transport (Set of 2)	12 Volt / 33.0 Ah	2395	\$170.00
Amigo HD, RD, Deluxe, Centra, Bajam GT (Set of 2)	12 Volt / 24.0 Ah	2393	\$140.00
Travel Mate (Set of 2)	12 Volt / 8.5 Ah	2390	\$66.00

<b>AM SCOOTERS</b>			
All Models (Set of 2)	12 Volt / 33.0 Ah	2395	\$170.00

<b>ARJO CENTURY</b>			
Alpine 600 (Requires 2/unit)	12 Volt / 7.0 Ah	5390	\$25.00
Arjo Patient Lift Encore, Opera, Tempo (KPA0100) (Retrofit)	24 Volt / 5.0 Ah	5050 C	\$125.00
Arjo Patient Lift (NDA0100-03, 0100-20, MA1100) (Retrofit)	24 Volt / 3.8 Ah	5050 D	\$85.00
Arjo Patient Lift with Handle, EZ Lift (4 Position Plug) (Retrofit)	24 Volt / 5.0 Ah	5050 A-R	\$66.00
Arjo Patient Lift with Handle, EZ Lift, Maxi Move (Retrofit)	24 Volt / 5.0 Ah	5050 E-R	\$66.00
Arjo Patient Lift with Handle (Retrofit)	24 Volt / 3.8 Ah	5050 B	\$85.00
Bravo Patient Lift (Requires 2/unit)	12 Volt / 7.2 Ah	5780	\$34.00
Century Chair Lift (102193)	12 Volt / 7.0 Ah	5390	\$25.00
Chair Lift 29181, 29182	12 Volt / 7.0 Ah	5390	\$25.00
Maxi Sky 400 Patient Lift (Requires 2/unit)	12 Volt / 2.5 Ah	5515	\$20.00
Maxi Sky 600 Patient Lift (Requires 2/unit)	12 Volt / 5.0 Ah	5388	\$25.00
Patient Lift Encore, Opera, Tempo (KPA0100) (Send in for Retrofit)	24 Volt / 5.0 Ah	5050 C	\$125.00
Patient Lift (NDA0100-03, 0100-20, MA1100) (Send in for Retrofit)	24 Volt / 3.8 Ah	5050 D	\$85.00
Patient Lift NEA0100-083 (Retrofit)	24 Volt / 3.0 Ah	6293	\$215.00
Patient Lift, Trixie (KTA0102) (Send in for Retrofit)	24 Volt / 2.9 Ah	5050 F	\$80.00
Patient Lift with Handle, EZ Lift (4 Position Plug)	24 Volt / 5.0 Ah	5050 A	\$66.00
Patient Lift with Handle, EZ Lift, Maxi Move (KPA0300) (3 Position Plug)	24 Volt / 5.0 Ah	5050 E	\$66.00
Patient Lift with Handle (Send in for Retrofit)	24 Volt / 3.8 Ah	5050 B	\$85.00

<b>BARTON</b>			
Ready Track (Requires 2/unit)	12 Volt / 5.0 Ah	5388	\$25.00

<b>BHM MEDICAL, INC.</b>			
Voyager (A8500)	24 Volt / 2.3 Ah	6138	\$90.00
Voyager Lift 420, V10, Ergolift 2, 600 (Requires 2/unit)	12 Volt / 7.0 Ah	5390	\$25.00
Voyager Lift 4V, 4Vi, Ergostand, Graduate, Junior, Medi-ssL2, Medilifter 4, Ministand (Requires 2/unit)	12 Volt / 5.0 Ah	5388	\$25.00
Voyager Lift V3 (Requires 2/unit)	12 Volt / 2.5 Ah	5515	\$20.00

<b>BRAUN</b>			
T1100/T1200F Series 1-3 (Set of 2)	12 Volt / 75.0 Ah	2901	\$350.00
T1100/T1200F Series 4 and up (Set of 2)	12 Volt / 33.0 Ah	2395	\$170.00

<b>BRUNO</b>			
Bruno Catalina, Firefighter, Outdoorsman, Police, Racecub, SuperCub 34, SuperCub 44, Thunder, Regal, Cub Rear Wheel Drive Models (Set of 2)	12 Volt / 33.0 Ah	2395	\$170.00
Cub 46 (Requires 2/unit)	12 Volt / 55.0 Ah	6274	\$125.00
Cub Front Wheel Drive (Set of 2)	12 Volt / 18.0 Ah	2391	\$130.00
Stairlifts (Set of 2)	12 Volt / 8.5 Ah	2390	\$66.00

<b>CARTER CO.</b>			
All Models (Set of 2)	12 Volt / 75.0 Ah	2901	\$350.00

<b>CHATTANOOGA GROUP</b>			
Alliance 1906 Patient Lift (Requires 2/unit)	12 Volt / 5.0 Ah	5388	\$25.00

<b>CHAUFFER MOBILITY</b>			
Chauffer Scooters, C-Series, Viva MWD Powerchair (Set of 2)	12 Volt / 33.0 Ah	2395	\$170.00
Lil Taxi (Set of 2)	12 Volt / 18.0 Ah	2391	\$130.00
Viva Powerchair (Requires 2/unit)	12 Volt / 55.0 Ah	6274	\$125.00

<b>DAMACO</b>			
Child's Elite (14x14) (Set of 2)	12 Volt / 18.0 Ah	2391	\$130.00
D90, D99, Ovation, Electro-Lite, Elite (Set of 2)	12 Volt / 33.0 Ah	2395	\$170.00

<b>DIGNIFIED PRODUCTS</b>			
All Models (Requires 1-2/unit)	12 Volt / 33.0 Ah	1395	\$85.00

<b>E.F. BREWER CO.</b>			
All Models	12 Volt / 33.0 Ah	1395	\$85.00

<b>ELECTRIC MOBILITY</b>			
Rascal MWD Power Chair (Set of 2)	12 Volt / 33.0 Ah	2395	\$170.00
Rascal Power Chair, Viva (Requires 2/unit)	12 Volt / 55.0 Ah	6274	\$125.00
Rascal Scooter, Cycle Chair, Butler (Requires 1-2/unit)	12 Volt / 33.0 Ah	1395	\$85.00
Rover, Sparky, Squire (Set of 2)	12 Volt / 75.0 Ah	2901	\$350.00

<b>ERGOLIFT</b>			
Luna Patient Lift	36 Volt / 2.3 Ah	6135	\$120.00

Mobility Lifts

<b>EVEREST &amp; JENNINGS</b>			
3N, Tempted, Metro Power, Quest, Kid Power 14" Belt Drive Chairs, Hot Wheels, Carrette, Mobile Navigator, Sprint II (Set of 2)	12 Volt / 33.0 Ah	2395	\$170.00
Xcaliber, Sprint, Sprint Plus, MX, Saber (ES, ES-GT, LTD) Marathon LE, 3P, 3W, 3H, 3V, Magnum, Xcaliber Power Recliner, Magnum Power Recliner, agator (Requires 2/unit)	12 Volt / 55.0 Ah	6274	\$125.00

<b>FALCON REHAB</b>			
All Models (Set of 2)	12 Volt / 75.0 Ah	2901	\$350.00

<b>FERNO ILLE</b>			
125, 128, 129 Chair Lift (Requires 2/unit)	12 Volt / 18.0 Ah	5391	\$65.00
1600, 9600, 9650 Chair Lift	12 Volt / 7.0 Ah	5390	\$25.00
190, 193, 194 Chair Lift	12 Volt / 26.0 Ah	5394	\$67.00
196, 197, 300 Chair Lift	12 Volt / 26.0 Ah	5392	\$67.00
5000, 6000 Chair Lift (Requires 2/unit)	12 Volt / 7.0 Ah	5390	\$25.00
Aquasizer 300	12 Volt / 2.9 Ah	5385	\$29.00
Power Flex (Requires 2/unit)	12 Volt / 7.2 Ah	5780	\$34.00
T.H.E. Medical Lift (Requires 4/unit)	6 Volt / 10.0 Ah	5380	\$18.00
TR3000 Shower Trolley	12 Volt / 7.0 Ah	5390	\$25.00

<b>FRANK MOBILITY</b>			
E-Fix (Set of 2)	12 Volt / 12.0 Ah	2551	\$90.00
E-Fix with High Capacity Case (Set of 2)	12 Volt / 18.0 Ah	2391	\$130.00

<b>GAYMAR-RETEC</b>			
All Models (Set of 2)	12 Volt / 75.0 Ah	2901	\$350.00

<b>GENDRON-SOLO</b>			
All Models (Requires 2/unit)	12 Volt / 55.0 Ah	6274	\$125.00

<b>GENUS</b>			
All Models (Set of 2)	12 Volt / 33.0 Ah	2395	\$170.00

<b>GLOBAL RESEARCH</b>			
Galaxy, Starlight 1 & 2	12 Volt / 33.0 Ah	1395	\$85.00
Starlight 3 (Set of 2)	12 Volt / 33.0 Ah	2395	\$170.00

<b>GOLDEN TECHNOLOGY</b>			
Golden Spirit (Set of 2)	12 Volt / 18.0 Ah	2391	\$130.00
Golden Tech Alante II (GP-202) (Requires 2/unit)	12 Volt / 55.0 Ah	6274	\$125.00
Golden Technologies Companion, Golden Technologies Companion II, Sterling, Scoota, Regent, Hawk, Scoota Bug, GSE 600, GSE 700, GSE 300, GSE 400 (Set of 2)	12 Volt / 33.0 Ah	2395	\$170.00

<b>GULDMANN</b>			
GH2HD Ceiling Lift (Requires 2/unit)	12 Volt / 5.0 Ah	5388	\$25.00

<b>HILLROM</b>			
Liftem Portable Lift (Requires 2/unit)	12 Volt / 2.9 Ah	5969	\$38.00
Trans Lift P4401B (Requires 2/unit)	12 Volt / 2.9 Ah	5969	\$38.00

<b>HORCHER</b>			
Lexa	12 Volt / 2.9 Ah	5969	\$38.00

<b>HOVEROUND</b>			
Activa DM, LX, Affinity, MPV 2/3/4, HRV (Set of 2)	12 Volt / 33.0 Ah	2395	\$170.00
Teknique HD (Set of 2)	12 Volt / 75.0 Ah	2901	\$350.00
Teknique RWD/FWD/GT (Requires 2/unit)	12 Volt / 55.0 Ah	6274	\$125.00

<b>HOYER (INVACARE &amp; LINAK)</b>			
Electric Lift (BAJ1-U011-01) (LINAK) (Retrofit)	24 Volt / 2.9 Ah	6058	\$75.00
EM01880 (Requires 2/unit)	12 Volt / 3.2 Ah	5679	\$36.75
HPL 402 Electric Lift RPL4501 (BAJ100001011) (LINAK) (Insert)	24 Volt / 2.9 Ah	6058-I	\$70.00
HPL 402 Electric Lift RPL4501 (BAJ100001011) (LINAK) (Retrofit)	24 Volt / 2.9 Ah	6058	\$75.00
Patient Lift 53001, 59105, Partner (0023000) 2 Packs	13.2 Volt / 4.3 Ah	5800 A	\$135.00
Patient Lift 53001, 59105, Partner (0023000) 4 Packs	13.2 Volt / 4.3 Ah	5800 B	\$135.00
Patient Lift 9701	12 Volt / 2.9 Ah	5573	\$38.00
Patient Lift RPA350, RPA450 (Requires 2/unit)	12 Volt / 7.2 Ah	5780	\$34.00
Patient Lift RPA600, Reliant 450, 450I, HPL-P (Requires 2/unit)	12 Volt / 2.9 Ah	5969	\$38.00
Pronto M41, M51, M61, M71, M91 (Requires 2/unit)	12 Volt / 33.0 Ah	5395	\$85.00
Venture 2 Patient Lift (Requires 2/unit)	12 Volt / 2.9 Ah	5969	\$38.00
Wingo Stretch Chair	12 Volt / 2.9 Ah	5969	\$38.00

<b>INDEPENDENCE CHAIR</b>			
All Models (Set of 2)	12 Volt / 33.0 Ah	2395	\$170.00

<b>INVACARE</b>			
Arrow, Range X, Torque, Ranger II RWD, Power 9000, Ranger II CAPT., Pronto R2, Excel FWD CAPT. (Requires 2/unit)	12 Volt / 55.0 Ah	6274	\$125.00
Arrow XT, Arrow Storm, Junior Storm (Set of 2)	12 Volt / 75.0 Ah	2901	\$350.00
Compact Folding Chair (Set of 2)	12 Volt / 24.0 Ah	2393	\$140.00
Jaguar, Rabbit, Power 9000 (14" wide or less), Booster, Tri Rolls, Flyer, Cat, Cat Basic, PTE, Tri Scoot I & II, Pronto 250, Excel, Ranger II MWD, Lynx LX-3 (Set of 2)	12 Volt / 33.0 Ah	2395	\$170.00
Lynx SX-3 (Set of 2)	12 Volt / 18.0 Ah	2391	\$130.00

<b>LAKEMATIC</b>			
All Models	12 Volt / 75.0 Ah	1901	\$175.00

<b>LEISURE LIFT / PACE SAVER / BURKE MOBILITY</b>			
All Other Models (Requires 1-2/unit)	12 Volt / 33.0 Ah	1395	\$85.00
Pediatric (Set of 2)	12 Volt / 24.0 Ah	2393	\$140.00

<b>LIKO</b>			
3000, Viking Series Patient Lift, Golvo 7007ES (Requires 2/unit)	12 Volt / 2.9 Ah	5969	\$38.00
Likorall R2R, 243 Patient Lift (Requires 2/unit)	12 Volt / 2.6 Ah	5082	\$34.00
Sabina, Sabina II Patient Lift (Requires 2/unit)	12 Volt / 2.9 Ah	5969	\$38.00

<b>LOVE LIFT</b>			
All Models (Set of 2)	12 Volt / 24.0 Ah	2393	\$140.00

Mobility  
Lifts

MOBILITY LIFT BATTERIES MFG/MODEL                      VOLTAGE/CAPACITY    R&D PART    LIST PRICE

<b>MART CART</b>			
Mart Cart LA 300 (Requires 2/unit)	12 Volt / 55.0 Ah	6274	\$125.00

<b>MEDCARE PRODUCTS</b>			
400001, 400003, 400013, 400019 Lift (Send in for Retrofit)	24 Volt / 5.0 Ah	5050 A	\$66.00
Bariatric Portable Ceiling Lift (Requires 2/unit)	12 Volt / 7.0 Ah	5390	\$25.00

<b>MEDICAL RESOURCE CO.</b>			
All Models (Set of 2)	12 Volt / 33.0 Ah	2395	\$170.00

<b>MEDI-MAN PRODUCTS</b>			
Patient Lift 4000, 7000, Medi Lifter 3 (Requires 2/unit)	12 Volt / 5.0 Ah	5388	\$25.00
Patient Lift 5000, 62200 (600LB) (Requires 2/unit)	12 Volt / 7.0 Ah	5390	\$25.00
Patient Lift 62200 (400LB) (Requires 2/unit)	6 Volt / 10.0 Ah	5380	\$18.00

<b>MERITS</b>			
Mertis MP3C, MPC3R, MP3W, MP1I Travel-Ease, SP43/44, MP3F, MP3CF, MP3U (Set of 2)	12 Volt / 33.0 Ah	2395	\$170.00
MP3HD (Set of 2)	12 Volt / 75.0 Ah	2901	\$350.00
MP3R, MP3R Gemini (Requires 2/unit)	12 Volt / 55.0 Ah	6274	\$125.00
S 533 Pioneer (Set of 2)	12 Volt / 8.5 Ah	2390	\$66.00
SP23 Pioneer, SP24 Pioneer (Set of 2)	12 Volt / 18.0 Ah	2391	\$130.00

<b>MEYRA</b>			
All Models (Requires 2/unit)	12 Volt / 40.0 Ah	5545	\$125.00

<b>MOBILITY MANUFACTURING</b>			
Bobcat (Set of 2)	12 Volt / 33.0 Ah	2395	\$170.00
Roadrunner, Coyote (Set of 2)	12 Volt / 24.0 Ah	2393	\$140.00

<b>MOLIFT</b>			
Power Pac Lift (Insert)	14.4 Volt / 1.8 Ah	5067-I	\$50.00
Power Pac Lift (Send in for Retrofit)	14.4 Volt / 1.8 Ah	5067	\$60.00

<b>MOTORVATOR</b>			
All Models (Requires 1-2/unit)	12 Volt / 33.0 Ah	1395	\$85.00

<b>NEWTON</b>			
All Models (Set of 2)	12 Volt / 33.0 Ah	2395	\$170.00

<b>OPTIWAY TECHNOLOGY (FORTRESS SCOOTER)</b>			
1700FS, 1704FS, 1700SP, 2000FS, 2200FS, 1600ACV, 2000 Mini (Set of 2)	12 Volt / 33.0 Ah	2395	\$170.00
2001LX, LXS, Centurion, Crusader (Requires 2/unit)	12 Volt / 55.0 Ah	6274	\$125.00

<b>ORTHO FAB/LIFESTYLES (FORTRESS WHEELCHAIRS)</b>			
655, 760, 760V, 760N, Spirit, Victory, 720, 770 (Set of 2)	12 Volt / 75.0 Ah	2901	\$350.00
755FS, 1000FS, Commuter (Set of 2)	12 Volt / 33.0 Ah	2395	\$170.00

<b>ORTHO KINETICS</b>			
All Other Models (Set of 2)	12 Volt / 33.0 Ah	2395	\$170.00
Outsider 4500, Sierra XL 460 (Set of 2)	12 Volt / 75.0 Ah	2901	\$350.00

<b>PERMOBIL</b>			
All Other Models (Set of 2)	12 Volt / 33.0 Ah	2395	\$170.00
Hexior, Koala (Requires 2/unit)	12 Volt / 40.0 Ah	5545	\$125.00

<b>PILLAR TECHNOLOGY</b>			
All Other Models (Set of 2)	12 Volt / 33.0 Ah	2395	\$170.00
Deluxe Power Chair (Requires 2/unit)	12 Volt / 55.0 Ah	6274	\$125.00
Deluxe Snappy (Set of 2)	12 Volt / 75.0 Ah	2901	\$350.00

<b>PRIDE MOBILITY</b>			
Celebrity, Hurricane, Laser Sports Series (Requires 2/unit)	12 Volt / 40.0 Ah	5545	\$125.00
Excel Series, Sidekick, Cyclone, Jazzy 1103, Jazzy 1103 Mini, Jazzy 1113 Portable, Jazzy 1143 Mighty, Legend, Maxima, Pride Jet 3, Rally, Sundancer, Victory (Set of 2)	12 Volt / 33.0 Ah	2395	\$170.00
Go Go Travel Vehicle, Revo, Sonic (Set of 2)	12 Volt / 12.0 Ah	2551	\$90.00
Jazzy 1101, Jazzy 1121, Jazzy 1122, Jazzy 1133, Jazzy 1170XL, Pride Jet 2, Quantum Blast 650, Quantum Blast 850, Quantum Blast HD, Quantum Blast Xtreme, Quantum Jazzy 1122, Quantum Jazzy 1133, Victory XL (Requires 2/unit)	12 Volt / 55.0 Ah	6274	\$125.00
Quantum 1400, Quantum 1420, Quantum 1470 (Set of 2)	12 Volt / 75.0 Ah	2901	\$350.00
Sidekick (Set of 2)	12 Volt / 24.0 Ah	2393	\$140.00
Wrangler (Requires 2/unit)	12 Volt / 100 Ah	5987	\$215.00

<b>QUICKIE</b>			
P100, P110, P110 (14' Wide), P190, P500 (Set of 2)	12 Volt / 33.0 Ah	2395	\$170.00
P300 (All), P200, P210, P320 (Set of 2)	12 Volt / 75.0 Ah	2901	\$350.00

<b>RABJOR</b>			
All Models (Set of 2)	12 Volt / 33.0 Ah	2395	\$170.00

<b>RANGER ALL SEASON</b>			
1X3, 2X3 (Set of 4)	12 Volt / 33.0 Ah	4395	\$340.00
All Other Models (Set of 2)	12 Volt / 33.0 Ah	2395	\$170.00

<b>SEARS</b>			
16375-16376 (Requires 2/unit)	12 Volt / 55.0 Ah	6274	\$125.00
16481-16482 (Set of 2)	12 Volt / 33.0 Ah	2395	\$170.00

<b>SHEPARD-MEYRA</b>			
All Models (Set of 2)	12 Volt / 75.0 Ah	2901	\$350.00

<b>SHERRY PRODUCTS</b>			
Electra	12 Volt / 75.0 Ah	1901	\$175.00
Sparky (Requires 2/unit)	12 Volt / 55.0 Ah	6274	\$125.00

<b>SHOPRIDER</b>			
777-3/4 Sunrunner, 777-3LA Traveler, 777-4WA Snazzy2 (Set of 2)	12 Volt / 18.0 Ah	2391	\$130.00

Mobility Lifts



<b>SOLO PRODUCTS</b>			
High Speed - Steep Climber (Requires 2/unit)	12 Volt / 55.0 Ah	6274	\$125.00
Sport About (Set of 2)	12 Volt / 75.0 Ah	2901	\$350.00

<b>STAND-AID</b>			
Power Drive (Set of 2)	12 Volt / 33.0 Ah	2395	\$170.00
Power Lift	12 Volt / 33.0 Ah	1395	\$85.00

<b>STEVENS MOTOR CHAIR</b>			
All Models (Set of 2)	12 Volt / 75.0 Ah	2901	\$350.00

<b>SUITER</b>			
All Models (Set of 2)	12 Volt / 18.0 Ah	2391	\$130.00

<b>SUNRISE MEDICAL</b>			
CHLA Lift	12 Volt / 33.0 Ah	5395	\$85.00
EMD 1800 Lift	12 Volt / 3.4 Ah	5384	\$25.00

<b>TEFTEC</b>			
All Models (Set of 2)	12 Volt / 75.0 Ah	2901	\$350.00

<b>T.H.E. MEDICAL</b>			
Medical Lift (Requires 4/unit)	6 Volt / 10.0 Ah	5380	\$18.00
Titan X Bariatric Lift (Requires 2/unit)	12 Volt / 12.0 Ah	5551	\$45.00

<b>THE MEN GROUP</b>			
All Models (Set of 2)	12 Volt / 75.0 Ah	2901	\$350.00

<b>THERADYNE</b>			
All Other Models (Requires 2/unit)	12 Volt / 40.0 Ah	5545	\$125.00
EV1776, EV1866 (Pediatric Models) (Set of 2)	12 Volt / 24.0 Ah	2393	\$140.00
Investigator - Power T-Bird (Set of 2)	12 Volt / 33.0 Ah	2395	\$170.00
Rover (Set of 2)	12 Volt / 75.0 Ah	2901	\$350.00

<b>TRU MOBILITY</b>			
All Models (Requires 1-2/unit)	12 Volt / 18.0 Ah	1391	\$65.00

<b>TUFFCARE</b>			
All Other Models (Set of 2)	12 Volt / 33.0 Ah	2395	\$170.00
Challenger Extra Wide (Set of 2)	12 Volt / 75.0 Ah	2901	\$350.00

<b>VANCARE</b>			
Vanderlift 600 (Requires 2/unit)	12 Volt / 7.0 Ah	5390	\$25.00

<b>VECTOR MOBILITY</b>			
Pediatric (Set of 2)	12 Volt / 33.0 Ah	2395	\$170.00

<b>VOLARO</b>			
Patient Lift (10048-2) (Send in for Retrofit)	12 Volt / 12.0 Ah	6282	\$56.50

<b>ACOMA MEDICAL IMAGING</b>			
MBA 130 Portable Batteries Only (Requires 9/unit)	12 Volt / 26.0 Ah	5393	\$67.00
MBA 200 Portable Batteries Only (Requires 9 Per Unit)	12 Volt / 12.0 Ah	5551	\$45.00

<b>BENNETT X-RAY TECHNOLOGIES</b>			
Contour Mammography Unit Batteries Only (Requires 20 Per Unit)	12 Volt / 5.0 Ah	5388	\$25.00
HFQ300SE Batteries Only (Requires 30 Per Unit)	12 Volt / 2.5 Ah	0819-0020	\$40.00
HFQ600SE Batteries Only (Requires 60 Per Unit)	12 Volt / 2.5 Ah	0819-0020	\$40.00
HMX5 Batteries Only (Requires 10 Per Unit)	12 Volt / 33.0 Ah	5395	\$85.00
MF1500 Batteries Only (Requires 24 Per Unit)	12 Volt / 2.5 Ah	0819-0020	\$40.00
MF150 Batteries Only (Requires 20 Per Unit)	12 Volt / 2.5 Ah	0819-0020	\$40.00

<b>CANNON</b>			
RadPro 32kw Drive (Requires 8/unit)	12 Volt / 9.0 Ah	1986	\$34.00
RadPro 32kw Generator (Requires 30/unit)	12 Volt / 12.0 Ah	5551	\$45.00

<b>CGR MEDICAL GROUP</b>			
Batrix Portable X-Ray (Requires 10 Per Unit)	12 Volt / 17.0 Ah	6081	\$74.75
Batrix & Raytheon RMX Includes Set of (8) 12 Volt / 26Ah Batteries in two trays	96 Volt / 26.0 Ah	6234	\$1,300.00
Batrix & Raytheon RMX Includes Set of (8) 12 Volt / 26Ah Batteries in two trays with constant voltage charge board	96 Volt / 26.0 Ah	6233	\$1,545.00

<b>GE MEDICAL SYSTEMS</b>			
AMX-110, II, III Portable Set of (9) 12 Volt / 26Ah Batteries in three trays with constant voltage charge board, kicker panel and installation manual. Direct replacement for NiCd battery systems.	108 Volt / 26.0 Ah	6238	\$1,750.00
AMX-110, II, III Portable Set of (9) in three trays 12 Volt / 26Ah Batteries	108 Volt / 26.0 Ah	6240	\$1,250.00
AMX-110, II, III Portable Set of (9) in three trays with constant voltage charge board, installation manual 12 Volt / 26Ah Batteries	108 Volt / 26.0 Ah	6239	\$1,575.00
AMX-4DR Set of (9) Pre-Assembled in three trays with sensor kit 12 Volt / 30Ah Batteries	108 Volt / 33.0 Ah	6249	\$1,700.00
AMX-III Portable Set of (10) 12 Volt / 22Ah Batteries in two trays	120 Volt / 22.0 Ah	6237	\$1,140.00
AMX-III Portable Set of (10) 12 Volt / 22Ah Batteries in two trays with constant voltage regulator board, 100 ohm 25 watt resistor, new E-Proms and installation manual	120 Volt / 22.0 Ah	6236	\$1,550.00
AMX-IV, IV Plus Portable Batteries Only Genesis G26EP (Requires 9 Per Unit)	12 Volt / 26.0 Ah	5970	\$194.00
AMX-IV, IV Plus Portable Batteries Only - Hawker SBS30 Orange in color, threaded post terminals (Requires 9 Per Unit)	12 Volt / 26.0 Ah	SBS30	\$242.00
AMX-IV, IV Plus Portable Batteries Only - Panasonic LC-X1228AP - Threaded Post Terminal (Requires 9 Per Unit)	12 Volt / 28.0 Ah	5850	\$110.00
AMX-IV, IV Plus Portable Batteries Only - Panasonic LC-X1228P - Nut & Bolt Terminal (Requires 9 Per Unit)	12 Volt / 28.0 Ah	5850-B	\$110.00
AMX-IV, IV Plus Portable Set of (9) G26EP Genesis batteries with brackets 12 Volt / 26Ah Batteries	108 Volt / 26.0 Ah	5967	\$1,625.00
AMX-IV, IV Plus Set of (9) Genesis Batteries Pre-Assembled in three trays with sensor board to read individual battery voltages and installation manual	108 Volt / 26.0 Ah	6242	\$2,500.00

X-Ray

<b>GE MEDICAL SYSTEMS ... continued from previous page</b>			
AMX-IV, IV Plus Set of (9) HBC 12 Volt / 26Ah Batteries Pre-Assembled in three trays with sensor board to read individual battery voltages and installation manual	108 Volt / 26.0 Ah	6247	\$1,530.00
AMX-IV, IV Plus Set of (9) HBS 12 Volt / 30Ah Batteries Pre-Assembled in three trays with sensor board to read individual battery voltages and installation manual	108 Volt / 30.0 Ah	6243	\$1,625.00
AMX-IV, IV Plus Set of (9) Panasonic 12 Volt / 28Ah Batteries Pre-Assembled in three trays with sensor board to read individual battery voltages and installation manual	108 Volt / 28.0 Ah	6245	\$2,050.00
AMX-IV, IV Plus Set of (9)Pre-Assembled in three trays HBC 12 Volt / 26Ah Batteries	108 Volt / 26.0 Ah	6248	\$1,450.00
AMX-IV, IV Plus Set of (9)Pre-Assembled in three trays HBS 12 Volt / 30Ah Batteries	108 Volt / 30.0 Ah	6244	\$1,525.00
AMX-IV, IV Plus Set of (9)Pre-Assembled in three trays Panasonic 12 Volt / 28Ah Batteries	108 Volt / 28.0 Ah	6246	\$2,000.00
AMX Optima 220-Exchange, (4)Packs Pre-assembled	144 Volt / 16.0 Ah	6453	\$4,200.00
AMX Optima 220 Insert only	144 Volt / 16.0 Ah	6453-I	\$1,680.00
CMX, AMX-110, II Portable Batteries Only (10 Battery Set)	120 Volt / 22.0 Ah	6235	\$785.00
CMX, AMX-110, II Portable Set of (10)Batteries in two trays 12 Volt / 22Ah	120 Volt / 22.0 Ah	6232	\$1,140.00
CMX, AMX-110, II Portable Set of (10)Batteries in two trays with constant voltage charge kit 12 Volt / 22Ah	120 Volt / 22.0 Ah	6231	\$1,340.00
Definium AMX-700 Pre-Assembled in three trays With sensor kit	108 Volt / 33.0 Ah	6325	\$2,495.00

<b>LORAD MEDICAL</b>			
RT125 (Requires 10 Per Unit)	12 Volt / 33.0 Ah	5395	\$85.00
Transpo 350 (Requires 2 Per Unit)	12 Volt / 18.0 Ah	5391	\$65.00

<b>OEC</b>			
6800 C-Arm (Memory)	3 Volt / .255 Ah	6033	\$6.00
85 Power Unit (Requires 2 Per Unit)	12 Volt / 7.0 Ah	5390	\$25.00
9000, 9400 C-Arm 12 Volt / 5.0Ah SLA Cells (3 Battery Set)	180 Volt / 5.0 Ah	5101-B	\$915.00
9000, 9400 C-Arm (EnerSys) 00871327-01 (3 Battery Set)	180 Volt / 5.0 Ah	5101	\$915.00
9000 9400 C-Arm (Memory)	4.5 V Clock Battery	840/844	\$18.00
9400 Board	3.6 Volt / .06 Ah	5488	\$15.00
9600, 9800, 9900 C-Arm 12 Volt / 2.9Ah SLA Cells (2 Battery Set)	192 Volt / 2.9 Ah	5102-B	\$915.00
9600, 9800, 9900 C-Arm EnerSys Cyclon Cells (2 Battery Set)	192 Volt / 2.5 Ah	5102	\$865.00
9600 C-Arm (Memory)	3.6 Volt / .06 Ah	5488	\$15.00
9800 CMOS	Real Time Clock (IC)	6134	\$20.00
ON 400 (Requires 2 Per Unit)	12 Volt / 5.0 Ah	5388	\$25.00
Uroview 2000 Set of (32) 12 Volt / 12Ah Batteries Pre-Assembled in four trays with new wiring kit, sensor kit, and thermal strip to read individual cell voltages	384 Volt / 12.0 Ah	6099-A	\$2,032.00
Uroview 2500, 2600 Set of (36) 12 Volt / 12Ah Batteries Pre-Assembled in four trays with new wiring kit, sensor kit, and thermal strip to read individual cell voltages	420 Volt / 12.0 Ah	6099-B	\$2,150.00

<b>PHILIPS MEDICAL SYSTEMS</b>			
BV300, BV-Pulsera C-Arm Batteries Only (52 Battery Set)	312 Volt / 2.5 Ah	6078-I	\$1,040.00
BV300, BV-Pulsera C-Arm - No charger board (Exchange)	312 Volt / 2.5 Ah	6078-A	\$4,500.00
BV300, BV-Pulsera C-Arm - No charger board (No Exchange)	312 Volt / 2.5 Ah	6078-A	\$4,500.00
BV300, BV-Pulsera C-Arm (Send in for Retrofit)	312 Volt / 2.5 Ah	6078	\$1,140.00
PMX-2000 Batteries Only (Requires 10 Per Unit)	12 Volt / 33.0 Ah	5395	\$85.00

**PHILIPS MEDICAL SYSTEMS ... continued from previous page**

PMX Portable (10) 12 Volt / 22Ah Batteries Pre-Assembled in two trays, new wiring and installation manual	120 Volt / 22.0 Ah	6255	\$1,150.00
PMX Portable (10) 12 Volt / 22Ah Batteries Pre-Assembled in two trays, new wiring, constant voltage charger board and installation manual	120 Volt / 22.0 Ah	6254	\$1,350.00
PMX Portable Batteries Only (Requires 10 Per Unit)	12 Volt / 18.0 Ah	5391	\$65.00

**PICKER INTERNATIONAL**

Explorer (Requires 14 Per Unit)	12 Volt / 28.0 Ah	PG-12V28FR	\$125.95
Meteor (Requires 10 Per Unit)	12 Volt / 33.0 Ah	LC-R1233P	\$132.25
Techmobile Batteries Only (Requires 12 Per Unit)	12 Volt / 18.0 Ah	5391	\$65.00
Techmobile Set of (12) 12 Volt / 18Ah Batteries Pre-Assembled in three packs, constant voltage regulator board, wiring kit and installation manual	120 Volt / 22.0 Ah	6256	\$1,625.00
Techmobile Set of (12)Pre-Assembled in three packs 12 Volt / 18Ah Batteries	120 Volt / 22.0 Ah	6257	\$1,200.00

**RADPRO**

HF Portable Digital Radiology (Requires 38 Per Unit)	12 Volt / 9.0 Ah	1986	\$34.00
--	------------------	------	---------

**SHIMADZU MEDICAL**

Mobile Star II (Requires 20 Per Unit)	12 Volt / 9.0 Ah	1986-F1	\$34.00
Mobile X-Ray WFLNIC-125 Batteries Only (Requires 2 Per Unit)	12 Volt / 33.0 Ah	LC-R1233P	\$132.25
MUX-100, MUX-100D Batteries Only (Requires 20 Per Unit)	12 Volt / 9.0 Ah	UP-VW1245P1	\$39.00

**SIEMENS MEDICAL**

Mobilett Batteries Only (Substitute for Sonnenschein listed above)	12 Volt / 12.0 Ah	5551	\$45.00
Mobilett Plus HP, Plus X Batteries Only (Requires 16 Per Unit)	12 Volt / 10.0 Ah	6018	\$88.00
Mobilett XP Digital Batteries Only (Requires 16 Per Unit)	12 Volt / 9.0 Ah	1986	\$34.00
Mobilett XP Hybrid Batteries Only (Requires 24 Per Unit)	12 Volt / 9.0 Ah	1986	\$34.00

**TOSHIBA**

KCD-10M6AT Mobile Batteries Only (Requires 2 Per Unit)	12 Volt / 28.0 Ah	PG-12V28FR	\$125.95
KCD-10M-7 Mobile Batteries Only (Requires 2 Per Unit)	12 Volt / 28.0 Ah	PG-12V28FR	\$125.95
KCD-10M-8, 10M-8A Batteries Only (Requires 2 Per Unit)	12 Volt / 28.0 Ah	PG-12V28FR	\$125.95
KCD-12M, 12M-2 Batteries Only (Requires 4 Per Unit)	12 Volt / 18.0 Ah	PS-12180B	\$65.00
KCD-12MC, 12MCD Batteries Only (Requires 2 Per Unit)	12 Volt / 55.0 Ah	PS-12550	\$125.00

X-Ray

DESCRIPTION	PART #	PRICE
<b>LIFEPAK 12 DEFIBRILLATOR/MONITOR SERIES</b>		
<b>POWER OPTIONS - (Defibrillator/Monitor requires 2 batteries for operation)</b>		
<b>LIFEPAK Li-Ion Battery</b> Rechargeable, lithium-ion, 7.2 amp hour capacity	11141-000106	\$415.00
<b>LIFEPAK NiCd Battery</b> Rechargeable nickel-cadmium, with fuel gauge, 1.6 amp hour capacity	11141-000149	\$295.00
<b>LIFEPAK SLA Battery</b> Rechargeable, sealed, lead-acid, 2.5 amp hour capacity.	11141-000028	\$222.00
<b>Battery Support System 2</b> For use with any of the above batteries. Includes power cord and operating instructions. (Batteries not included.)	99407-000002	\$1,785.00
<b>Wall Mount Bracket for Battery Support System 2</b>	11210-000002	\$116.00
<b>AC Power Adapter</b> (Carrying case not available to fit this configuration.)	11400-000038	\$840.00
<b>Power Adapter Extension Cable for Use with LIFEPAK 12</b> Optional use with AC Power Adapter.	11110-000051	\$130.00
<b>ECG MONITORING AND THERAPY DELIVERY ACCESSORIES</b>		
<b>3-Wire ECG Cable</b> Right angle connector.	11110-000029	\$128.00
<b>5-Wire ECG Cable</b> Right angle connector. 4 limb wire plus 1 chest lead, labeled "V1" on the LIFEPAK 12 reports.	11110-000066	\$228.00
<b>QUIK-COMBO Therapy Cable</b> For use with LIFEPAK 12 defibrillator/monitor.	11110-000040	\$305.00

<b>LIFEPAK 15 DEFIBRILLATOR/MONITOR SERIES</b>		
<b>POWER OPTIONS</b>		
<b>LIFEPAK Li-Ion Battery</b> Rechargeable, lithium-ion, 5.7 amp hour capacity	21330-001176	\$432.00
<b>ECG MONITORING AND THERAPY DELIVERY ACCESSORIES</b>		
<b>5-Wire ECG Cable</b> Right angle connector. 4 limb wire and 1 chest lead, labeled "V1" on the monitor/defibrillator reports.	11110-000066	\$199.00
<b>NIBP ACCESSORIES</b>		
<b>Adult Cuff - 14x37.5 cm Reusable</b>	11996-000024	\$26.00
<b>Large Adult Cuff - 16x42 cm Reusable</b>	11996-000025	\$29.00
<b>Small Adult Cuff - 12x30 cm Reusable</b>	11996-000023	\$25.00
<b>Child Cuff (Pediatric) - 9x27 cm Reusable</b>	11996-000022	\$21.00
<b>Small Child Cuff - 7x21 cm Reusable</b>	11996-000021	\$21.00

<b>LIFEPAK 20 DEFIBRILLATOR/MONITOR SERIES</b>		
<b>ECG MONITORING AND THERAPY DELIVERY ACCESSORIES</b>		
<b>3-Lead ECG Cable</b> Right angle connector	11110-000029	\$110.00
<b>5-Wire ECG Cable</b> Right angle connector, 4-limb wire, plus 1 chest lead, labeled "C" on the device reports.	11110-000066	\$199.00
<b>POWER OPTIONS</b>		
<b>LIFEPAK NiMH Battery</b> Rechargeable nickel-metal hydride battery, 3.0 amp hour capacity	11141-000068	\$172.00

DESCRIPTION	PART #	PRICE
<b>LIFEPAK 20e DEFIBRILLATOR/MONITOR SERIES</b>		
<b>POWER OPTIONS</b>		
<b>LIFEPAK Li-Ion Battery</b> Rechargeable Lithium-Ion 6.0 amp hour battery	11141-000112	\$255.00

<b>LIFEPAK 500 AUTOMATED EXTERNAL DEFIBRILLATOR</b>		
<b>POWER OPTIONS</b>		
<b>LIFEPAK Lithium Battery</b> Non-rechargeable, lithium, 7.5 amp hour capacity	11141-000013	\$275.00
<b>LIFEPAK SLA Battery</b> Rechargeable sealed lead acid, 2.5 amp hour capacity	11141-000002	\$195.00
<b>Battery Charger</b>	11140-000002	\$217.00
<b>ELECTRODES</b>		
<b>EDGE System electrodes with QUIK-COMBO connector and REDI-PAK preconnect system</b>		
1 to 9 pair		\$42.00/pr
10 to 49 pairs	11996-000017	\$37.00/pr
50 or more pairs		\$31.00/pr

<b>LIFEPAK 1000 AUTOMATED EXTERNAL DEFIBRILLATOR</b>		
<b>POWER OPTIONS</b>		
<b>LIFEPAK Lithium Battery</b> Non-rechargeable, lithium, 4.5 amp hour capacity	11141-000100	\$334.00

<b>LIFEPAK CR PLUS AUTOMATED EXTERNAL DEFIBRILLATOR</b>		
<b>POWER OPTIONS</b>		
<b>LIFEPAK Lithium Battery</b> Non-rechargeable Lithium, 1.5 amp hour battery	111403-000002	\$88.00

<b>LUCAS 2 CHEST COMPRESSION SYSTEM</b>		
<b>POWER OPTIONS</b>		
<b>LIFEPAK Li-Ion Battery</b> Rechargeable Lithium-Polymer, 3.3 amp hour battery	11576-000039	\$652.00

<b>MISCELLANEOUS</b>		
<b>EDGE SYSTEM ELECTRODES FOR PACING/DEFIBRILLATION/ECG WITH QUIK-COMBO CONNECTORS</b> (18 month minimum shelf life remaining at time of shipment from Physio-Control except where noted.)		
<b>EDGE System electrodes with QUIK-COMBO connector</b>		
1 to 9 pairs		\$37.00/pr
10 to 49 pairs	11996-000091	\$31.00/pr
50 or more pairs		\$26.00/pr
<b>EDGE System electrodes with QUIK-COMBO connector and REDI-PAK preconnect system</b>		
1 to 9 pairs		\$42.00/pr
10 to 49 pairs	11996-000017	\$37.00/pr
50 or more pairs		\$31.00/pr
<b>OTHER DEFIBRILLATION AND PACING ELECTRODES</b> (12 month minimum shelf life at time of shipment)		
<b>QUIK-PACE disposable noninvasive pacing electrodes</b>		
1 to 24 pairs		\$44.00/pr
25 or more pairs	11996-000042	\$35.50/pr

Physio  
Control

**MISCELLANEOUS continued...****CABLES FOR LIFEPAK DEFIBRILLATORS**

<b>QUIK-COMBO therapy cable</b> For use with LIFEPAK 12 and 20/20e defibrillator/monitors	11110-000040	\$351.00
--	--------------	----------

**QUIK-COMBO ADAPTERS FOR COMPETITIVE EQUIPMENT**

<b>ZOLL Adapter:</b> Converts ZOLL connector to QUIK-COMBO connector Note: Order must be called in by Sales or Service Rep	11103-000005	\$59.00
---	--------------	---------

**MASIMO SET SPO2 CABLES FOR LIFEPAK 12 AND 20/20E DEFIBRILLATOR/MONITORS**

<b>MNC-1 Adapter Cable:</b> Allows LIFEPAK 12 and specially configured LIFEPAK 20e with Masimo SpO2 to connect to Nellcor sensors (10 ft)	11996-000183	\$524.00
---	--------------	----------

**NIBP SUPPLIES**

<b>Adult Cuff, 14x37.5 cm Reusable</b>	11996-000024	\$26.00
<b>Large Adult Cuff, 16x42 cm Reusable</b>	11996-000025	\$29.00
<b>Small Adult Cuff, 12x30 cm Reusable</b>	11996-000023	\$25.00
<b>Child Cuff (Pediatric), 9x27 cm Reusable</b>	11996-000022	\$21.00
<b>Small Child Cuff, 7x21 cm Reusable</b>	11996-000021	\$21.00

**ETCO2 CIRCUITS FOR NON-INTUBATED APPLICATIONS**

<b>Smart CapnoLine Plus Adult/Intermediate</b> (for patients above 44 lbs) CO2 sampling via the mouth or the nose (12 hours typical length of use): pack of 10	11996-000297	\$120.00
--	--------------	----------

DESCRIPTION	PART #	PRICE
<b>AED PLUS ACCESSORIES</b>		
<b>ELECTRODES</b>		
<b>CPR-D Padz</b> One piece defibrillation and CPR System with compression, depth and rate sensors. Supplied with gloves, barrier mask, scissors, razor, wet wipe and dry wipe. Five year shelf-life. Special "long-life armor pack" for storage in softpak carry case.	8900-0800-01	\$169.00
<b>CPR-D Padz Training Electrodes</b> Reusable "Z-design" electrode with CPR hand placement indicator and (1) pair of disposable adhesive gels. (Disposable gels must be applied to reusable pad before use.)	8900-0804-01	\$90.00
<b>CPR-D Accessory Kit</b> Contains CPR barrier mask, scissors, gloves, prep razor, towel, and moist towelette in a small zip-lock pouch.		
1 kit	8900-0807-01	\$19.00
1 case of 50 kits	8900-0808-01	\$800.00
<b>Pedi-padz II Pediatric Multi-Function Electrodes</b> Designed for use with the ZOLL AED Plus defibrillaor. The AED recognizes when Pedi-padz II are connected and automatically proceeds with a pediatric ECG and adjusts energy to pediatric levels. Twenty four (24) month shelf-life. One pair.	8900-0810-01	\$95.00
<b>Stat-padz II HVP Multi-Function Electrodes</b>		
1 pair	8900-0801-01	\$59.00
1 case of 12 pairs	8900-0802-01	\$499.00
<b>Stat-padz II Training Electrodes</b> 6 pairs per case.	8900-0805-01	\$129.00
<b>BATTERY SUPPORT</b>		
<b>Type 123 Lithium Batteries</b> Quantity of (10) with storage sleeve.	8000-0807-01	\$75.00
<b>MISCELLANEOUS ACCESSORIES</b>		
<b>Defibrillator Analyzer Adapter</b> Connects AED Plus to defibrillator analyzer	8000-0804-01	\$105.00
<b>Simulator/Tester</b> Connects AED Plus to demonstrate operation.	8000-0819-01	\$239.00
<b>DATA RETRIEVAL / MEDICAL CONTROL SOFTWARE</b>		
<b>RescueNet Code Review Software - Physical copy.</b>	8000-0608-01	\$95.00
<b>USB IrDA Adapter</b>	8000-0815	\$105.00
<b>RS-232 IrDA Adapter</b>	8000-0816	\$105.00

<b>AED PRO ACCESSORIES</b>		
<b>ELECTRODES</b>		
<b>CPR-D Padz</b> One piece defibrillation and CPR System with compression, depth and rate sensors. Supplied with gloves, barrier mask, scissors, razor, wet wipe and dry wipe. Five year shelf-life. Special "long-life armor pack" for storage in softpak carry case.	8900-0800-01	\$169.00
<b>Pedi-padz II Pediatric Multi-Function Electrodes</b> Designed for use with the ZOLL AED Pro defibrillaor. The AED recognizes when Pedi-padz II are connected and automatically proceeds with a pediatric ECG and adjusts energy to pediatric levels. Twenty four (24) month shelf-life. One pair.	8900-0810-01	\$95.00
<b>Stat-padz II HVP Multi-Function Electrodes</b>		
1 pair	8900-0801-01	\$59.00
1 case of 12 pairs	8900-0802-01	\$499.00
<b>AED Pro Non-Rechargeable Lithium Battery Pack</b>	8000-0860-01	\$160.00
<b>1400/1600/1700/2000/M Series/AED Pro Battery</b> Not upgradeable to Smart Battery (Formerly 8004-0009)	8000-0299-01	\$140.00



DESCRIPTION	PART #	PRICE
<b>AED PRO ACCESSORIES...continued</b>		
<b>BATTERY SUPPORT</b>		
<b>Smart Battery Complete 1400/1600/1700/2000/M Series/AED Pro</b>	8004-0103-01	\$215.00
<b>Smart Ready Battery</b>	8004-0104-01	\$160.00
<b>SurePower Rechargeable Lithium-Ion Battery Pack</b> 5.8Ah capacity. High density lithium-ion chemistry. Run Time indicator. Automatic calibration ready. Stores history of use and maintenance.	8019-0535-01	\$475.00
<b>CABLES</b>		
<b>AED Pro ECG Cable AAMI</b>	8000-0838	\$160.00
<b>Defibrillator Analyzer Adapter</b> Connects AED Pro to defibrillator analyzer	8000-0804-01	\$105.00
<b>DATA RETRIEVAL / MEDICAL CONTROL SOFTWARE</b>		
<b>RescueNet Code Review Software - Physical copy.</b>	8000-0608-01	\$95.00
<b>USB IrDA Adapter</b>	8000-0815	\$105.00
<b>RS-232 IrDA Adapter</b>	8000-0816	\$105.00

<b>M SERIES ACCESSORIES</b>		
<b>ELECTRODES</b>		
<b>Stat-padz HVP Multi-Function Electrodes</b>		
1 pair	8900-4004	\$55.00
1 case of 12 pairs	8900-4003	\$479.00
<b>Stat-padz HVP Multi-Function Electrodes CPR</b>		
1 pair	8900-0402	\$75.00
1 case of 8 pairs	8900-0400	\$560.00
<b>Stat-padz II HVP Multi-Function Electrodes</b>		
1 pair	8900-0801-01	\$59.00
1 case of 12 pairs	8900-0802-01	\$499.00
<b>Pedi-padz Pediatric Multi-Function Electrodes</b>		
1 pair	8900-2061	\$60.00
1 case of 6 pairs	8900-2065	\$249.00
<b>Pedi-padz Solid Gel Radiolucent Pediatric Multi-Function Electrodes</b>		
1 pair	8900-1007-01	\$60.00
1 case of 6 pairs	8900-1005-01	\$249.00
<b>Pedi-padz Solid Gel Multi-Function Electrodes</b>		
1 pair	8900-3001-01	\$60.00
1 case of 6 pairs	8900-3000-01	\$249.00
<b>Pedi-padz Pacing Only Pediatric Electrodes</b>		
1 pair	8900-1061	\$60.00
1 case of 6 pairs	8900-1065	\$249.00
<b>Pedi-padz Reduced Energy Electrode - 1 Pair</b>		
	8900-0401	\$110.00
<b>Pro-padz Cardiology Specialty LVP Multi-Function Electrodes</b>		
1 pair	8900-2101-01	\$55.00
1 case of 12 pairs	8900-2100-01	\$479.00
<b>Pro-padz Biphasic Multi-Function Electrodes</b>		
1 pair	8900-2302-01	\$55.00
1 case of 12 pairs	8900-2303-01	\$479.00
<b>Pro-padz Solid Gel Radiolucent Multi-Function Electrodes</b>		
1 pair	8900-4006	\$65.00
1 case of 12 pairs	8900-4005	\$695.00
<b>Pro-padz Liquid Gel Radiolucent Multi-Function Electrodes</b>		
1 pair	8900-2106-01	\$65.00
1 case of 12 pairs	8900-2105-01	\$695.00
<b>Pro-padz Sterile Multi-Function Electrodes</b>		
1 pair	8900-4013	\$55.00
1 case of 6 pairs	8900-4012	\$285.00

DESCRIPTION	PART #	PRICE
<b>M SERIES ACCESSORIES...continued</b>		
<b>ELECTRODES</b>		
<b>Pro-padz Pacing Only Adult Electrodes</b>		
1 pair	8900-1051	\$75.00
1 case of 12 pairs	8900-1055	\$700.00
<b>ECG MONITORING ELECTRODES</b>		
<b>3 ECG Electrodes / Pouch - 200 pouches (600 electrodes)</b>	8900-0003	\$120.00
<b>4 ECG Electrodes / Pouch - 120 pouches (480 electrodes)</b>	8900-0004	\$96.00
<b>5 ECG Electrodes / Pouch - 100 pouches (500 electrodes)</b>	8900-0005	\$100.00
<b>6 ECG Electrodes / Pouch - 100 pouches (600 electrodes)</b>	8900-0006	\$120.00
<b>Pediatric ECG Electrodes - 3 per pouch / 100 pouches (300 electrodes)</b>	8900-1003-01	\$60.00
<b>V-pak Preconnected V Lead Electrodes for 12 Lead - 40 pouches</b>	8900-1300-01	\$340.00
<b>Rectangle Liquid Gel ECG Electrodes - 20 pouches (600 electrodes)</b>	8900-0700	\$120.00
<b>Round Liquid Gel ECG Electrodes - 1.5" diameter - 20 pouches (600 electrodes)</b>	8900-0701	\$120.00
<b>Rectangle Solid Gel ECG Electrodes - 20 pouches (600 electrodes)</b>	8900-0702	\$120.00
<b>Round Liquid Gel ECG Electrodes - 2" diameter - 20 pouches (600 electrodes)</b>	8900-0703	\$120.00
<b>Radiolucent ECG Electrodes - 1.5" diameter - 10 pouches (300 electrodes)</b>	8900-0704	\$60.00
<b>Square Liquid Gel ECG Electrodes - 20 pouches (600 electrodes)</b>	8900-0706	\$120.00
<b>Square Solid Gel ECG Electrodes - 20 pouches (600 electrodes)</b>	8900-0707	\$120.00
<b>Round Solid Gel ECG Electrodes - 1.5" diameter - 20 pouches (600 electrodes)</b>	8900-0708	\$120.00
<b>Pediatric ECG Electrodes - 120 pouches (480 electrodes)</b>	8900-0709	\$96.00
<b>PD 2200 Adult Multi-Function Electrodes</b>		
1 pair	8900-2051	\$55.00
1 case of 12 pairs	8900-2055	\$455.00
<b>Adult Cath Lab Multi-Function Electrodes</b>		
1 pair	8900-2751	\$55.00
1 case of 12 pairs	8900-2755	\$455.00
<b>Training Electrodes - 6 pairs</b>	8900-5005	\$80.00
<b>BATTERY SUPPORT</b>		
<b>1400/1600/1700/2000/M Series/AED Pro Battery</b>		
Not upgradeable to Smart Battery (Formerly 8004-0009)	8000-0299-01	\$140.00
<b>1200/900 Battery</b>	8000-0052	\$135.00
<b>Smart Battery Complete 1400/1600/1700/2000/M Series/AED Pro</b>	8004-0103-01	\$215.00
<b>Smart Ready Battery Upgrade (includes Smart Chip and indicator label)</b>	7777-0103-01	\$80.00
<b>Smart Battery Reconditioning Kit (includes Smart Ready Battery and indicator label)</b>	7776-0103-01	\$165.00
<b>Smart Battery Complete (replacement option of standard battery)</b>	8204-0103-01	\$55.00
<b>XL Smart Ready Battery</b>		
1 battery	8000-0500-01	\$265.00
Pack of 3 batteries	8000-0686-01	\$635.00
<b>XL Smart Ready Battery Upgrade (includes Smart Chip and indicator label)</b>	7777-0203-01	\$80.00
<b>ACCESSORIES</b>		
<b>Power Charger Clips</b>		
Includes 2 clips with instructions and label.	1004-0151-01	\$27.00
<b>Replacement Power Cord for Base Power Charger 4x4 or 1x1</b>	8000-0090	\$60.00
<b>Replacement Power Cord for Base Station Charger</b>	8000-0100	\$60.00
<b>CABLES</b>		
<b>Universal Cable</b>		
Allows use of paddles or multi-function electrodes.		
8'	8000-0308-01	\$135.00
12'	8000-0308-02	\$185.00
<b>5-Lead Patient Cable with Integral Lead Wires</b>	8000-1005-01	\$160.00
<b>1 Step Patient Cable for 12-Lead ECG with Limb and V Leads</b>		
7'	8000-1007-02	\$315.00
10'	8000-1007-01	\$315.00

DESCRIPTION	PART #	PRICE
<b>M SERIES ACCESSORIES...continued</b>		
<b>CABLES</b>		
<b>Limb Lead Patient Cable for 12-Lead ECG</b>		
7'	8000-1006-02	\$160.00
10'	8000-1006	\$160.00
<b>V Lead Patient Cable for 12-Lead ECG</b>		
2.5'	8000-1008-02	\$185.00
3.5'	8000-1008-01	\$185.00
<b>V Lead Patient Cable with Banana Plugs</b>	8012-0208	\$185.00
<b>RS232 Data Transfer Cable</b>	8000-0605-01	\$50.00
<b>Replacement RJ-11 Phone Cord</b>	8000-0780	\$25.00
<b>3-Lead ECG Patient Cable</b>		
6'	8000-0025-02	\$100.00
12'	8000-0025	\$135.00
<b>M Series Power Cord Extention Cable - 12'</b>	8000-0730	\$27.00
<b>12-Lead Modem Extention Cable - (Revision B)</b>		
For use with Ositech Cellular Read Modem and Viking Cellular Ready Modems.	8000-0086	\$135.00
<b>V Pak Adapter Cable for 12-Lead ECG Patient Cable</b>	8000-1009-01	\$135.00
<b>CASE ACCESSORIES</b>		
<b>Cable Management Accessory Pouch</b>	8000-0596-01	\$55.00
<b>Replacement Rear Pouch for Xtreme Pack II</b>	8000-0092-01	\$90.00
<b>Replacement Rear Pouch with Side Pockets for Xtreme Pack II</b>	8000-0095-01	\$160.00
<b>Xtreme Pack II Upgrade for 12-Lead</b>		
Includes base and modem extention cable.	7777-0129	\$210.00
<b>Replacement Front Flap for Xtreme Pack II with NIBP</b>	8000-0096	\$45.00
<b>Replacement Front Flap for Xtreme Pack II</b>	8000-0097	\$45.00
<b>Replacement Carry Strap</b>	8000-0735	\$37.00
<b>MISCELLANEOUS</b>		
<b>M Series External Paddle Assembly Apex/Sternum</b>		
With controls and built-in pediatric electrodes.	8000-1010-01	\$590.00
<b>M Series Anterior Posterior Paddle Assembly</b>	8000-1020	\$810.00
<b>ECG Simulator</b>	8000-1629	\$455.00
<b>12-Lead ECG Simulator</b>	8010-0206	\$1,065.00
<b>12-Lead ECG Simulator with IBP Channel</b>	8000-0684	\$1,385.00
<b>CPR Connector</b>	8000-0370	\$265.00
<b>M Series 2005 Guidelines Upgrade Kit</b>	7771-3875-01	\$210.00
<b>Recorder Paper 80mm Fan Fold</b>		
10 packages	8000-0302	\$40.00
20 packages	8000-0301	\$75.00
<b>Defibrillator Gel - 12 Tubes</b>	8000-0053	\$810.00

<b>R SERIES ACCESSORIES</b>		
<b>ONESTEP RESUSCITATION ELECTRODES</b>		
<b>OneStep Resuscitation Electrode - 8 per case</b>	8900-0211-01	\$320.00
<b>OneStep Pacing Resuscitation Electrode - 8 per case</b>	8900-0212-01	\$400.00
<b>OneStep CPR Resuscitation Electrode - 8 per case</b>	8900-0213-01	\$500.00
<b>OneStep CPR AA Electrode - 8 per case</b>	8900-0217-01	\$600.00
<b>OneStep Complete Resuscitation Electrode - 8 per case</b>	8900-0214-01	\$680.00
<b>OneStep Pediatric Resuscitation Electrode</b>		
1 pair	8900-0218-40	\$70.00
1 case of 8 pairs	8900-0215-40	\$520.00

DESCRIPTION	PART #	PRICE
<b>R SERIES ACCESSORIES...continued</b>		
<b>ONESTEP RESUSCITATION ELECTRODES</b>		
<b>OneStep Training Cable and Electrode</b> Includes one training cable with CPR sensor and Y-connector for simulator connection and one pair of replacement OneStep training electrodes.	8900-0180	\$139.00
<b>Replacement OneStep Training Electrodes - 8 per case</b>	8900-0185	\$99.00
<b>SUREPOWER DEFIBRILLATOR BATTERY SYSTEM</b>		
<b>SurePower Rechargeable Lithium-Ion Battery Pack</b> 5.8Ah capacity. High density lithium-ion chemistry. Run Time indicator. Automatic calibration ready. Stores history of use and maintenance.	8019-0535-01	\$475.00
<b>SurePower Charging Station</b> 4 charging bays. Multiple chemistry compatible. 200 watt capacity. Graphic driven user interface. RS-232 communication port.	8050-0030-01	\$2,275.00
<b>SurePower Charger Battery Wall Spacer</b>	8050-0032-01	\$20.00
<b>SurePower Battery Instructions</b>	9650-0536-01	\$25.00
<b>ONESTEP SYSTEM</b>		
<b>OneStep CPR Cable</b> Supports Real CPR Help.	8009-0749	\$475.00
<b>OneStep Pacing Cable</b> Supports both Real CPR Help and OneStep Pacing.	8009-0750	\$825.00
<b>OneStep Cable Manager</b> Includes mesh pockets and power cord extender.	1119-0051-01	\$80.00
<b>Power Cord Extender</b>	0500-0009	\$16.00
<b>OneStep ECG Leads - AHA (3 Leads Only)</b>	8009-0762-01	\$90.00
<b>CPR-D Padz Connector for R Series OneStep Cable</b>	8009-0020	\$375.00
<b>CABLES</b>		
<b>5-Lead Patient Cable with Integral Lead Wires</b>	8000-1005-01	\$160.00
<b>Replacement 3-Lead ECG Patient Cable - 12'</b>	8000-0025	\$135.00
<b>M Series Power Cord Extension Cable - 12'</b>	8000-0730	\$27.00
<b>Pacing Output Cable</b>	8000-0011	\$100.00
<b>ECG Out Adapter - Slave Cable</b>	8000-0013	\$75.00
<b>NTP-MFE Crossover Cable</b>	8000-0021	\$245.00
<b>Power Cord</b>	8000-0022	\$55.00
<b>Serial Link Cable and Connector</b>	8000-1614	\$27.00
<b>Multi-Function Cable - (1700)</b>	8000-1701	\$195.00
<b>Multi-Function Cable - (900/1200)</b>	8002-0003	\$435.00
<b>Multi-Function Cable - (1400/2000)</b>	8004-0005	\$465.00
<b>HP-MFE Cable - (works with HP 43100's)</b>	8002-0006	\$225.00
<b>MISCELLANEOUS</b>		
<b>R Series Electrode Pouch - Right Side</b>	8000-0963	\$70.00
<b>R Series Electrode Pouch - Left Side</b>	8000-0964	\$70.00
<b>R Series Operator's Guide</b>	9650-0900-01	\$25.00
<b>R Series Pulse Oximetry Insert</b>	9650-0901-01	\$25.00
<b>R Series Online Training</b>	8700-0890-01	\$495.00
<b>R Series In-Service DVD</b>	9658-0893-01	\$35.00
<b>R Series Service Manual</b>	9650-0903-01	\$50.00
<b>Quick Reference Guide for R Series - Pack of 25</b>	9650-1001-01	\$15.00
<b>See-Thru CPR Simulator for E Series, R Series and AED Pro</b>	8009-0751-01	\$495.00
<b>128 MB Compact Flash Data Card - R Series Only</b>	9143-0001	\$80.00
<b>Defibrillator Gel - 12 Tubes</b>	8000-0053	\$75.00
<b>ECG Simulator</b>	8000-1629	\$455.00
<b>12-Lead ECG Simulator</b>	8012-0206	\$1,065.00
<b>12-Lead ECG Simulator with IBP Channel</b>	8000-0684	\$1,385.00

T10Z

BARCODE	BATTERIES MFG/MODEL	VOLTAGE / CAPACITY	R&D PART	LIST PRICE
<b>CASIO</b>				
	HA-F21L	3.7 Volt / 2200mAh	BCS-HAF21LBAT	\$40.00
<b>DOLPHIN</b>				
	7200	3.6 Volt / 2100mAh	BCS-31MH	\$44.00
	7300, 7400, 7450	7.4 Volt / 2200mAh	BCS-7850Li	\$68.00
	7600	3.7 Volt / 3200mAh	BCS-7600	\$77.00
	7850	7.4 Volt / 2000mAh	BCS-7850Li	\$69.00
	7900, 9500, 9501, 9550, 9551, 9900	7.4 Volt / 2300mAh	BCS-7900Li	\$70.00
<b>FUJITSU</b>				
	STYLISTIC 500	7.4 Volt / 2300mAh	BCS-12Li	\$48.00
	STYLISTIC 1000	10.8 Volt / 4800mAh	BCS-14Li	\$293.00
	STYLISTIC 12000, 2300	10.8 Volt / 4800mAh	BCS-15Li	\$293.00
<b>HHP</b>				
	7450	3.6 Volt / 2700mAh	BCS-7450	\$68.00
	7850	7.4 Volt / 2000mAh	BCS-7850Li	\$69.00
	7900	7.4 Volt / 2300mAh	BCS-7900Li	\$70.00
	QUICK CHECK 200	4.8 Volt / 150mAh	BCS-QC200	\$17.00
<b>HUSKY</b>				
	FC-PX5, 486, 486P	7.2 Volt / 3800mAh	BCS-17MH	\$91.00
	FS2, FS3, MP2500	3.6 Volt / 1400mAh	BCS-18	\$16.00
	FS2, FS3, MP2500	3.6 Volt / 2700mAh	BCS-18MH	\$26.00
<b>INTERMEC</b>				
	ANTARES 2410, 2415	3.7 Volt / 2200mAh	BCS-30Li	\$77.00
	ANTARES 2420	7.4 Volt / 2300mAh	BCS-12Li	\$48.00
	CN2 COLOR COMPUTER	3.7 Volt / 2300mAh	BCS-CN2CL	\$54.00
	CN3	3.7 Volt / 3800mAh	BCS-CN3Li	\$84.00
	CK3	3.7 Volt / 5100mAh	BCS-CK3Li	\$93.00
	CN50	3.7 Volt / 3900mAh	BCS-CN50Li	\$87.00
	CK30	3.7 Volt / 5100mAh	BCS-CK30Li	\$75.00
	CK60	7.4 Volt / 2300mAh	BCS-CK60Li	\$68.00
	PB2-PB3	7.4 Volt / 2400mAh	BCS-PB2	\$48.00
	PB50 PRINTER	14.8 Volt / 2300mAh	BCS-PB50	\$91.00
	2410, 2415	3.7 Volt / 2200mAh	BCS-30Li	\$77.00
	5020, 5023, 5025 Data Collection Computer	7.4 Volt / 2300mAh	BCS-12Li	\$48.00
	6100, 6110	7.2 Volt / 1600mAh	BCS-23Li	\$140.00
	700 COLOR	7.4 Volt / 2300mAh	BCS-700CL	\$56.00
	700 MONO	3.7 Volt / 2300mAh	BCS-700MN	\$56.00
	9512		BCS-9512MH	\$12.00
<b>LXE</b>				
	2280	7.2 Volt / 700mAh	BCS-9	\$16.00
	2280	7.2 Volt / 1100mAh	BCS-9MH	\$23.00
	MX2	3.6 Volt / 1600mAh	BCS-16MH	\$28.00
	MX7	7.4 Volt / 2300mAh	BCS-MX7	\$61.00
	MX7	7.4 Volt / 3400mAh	BCS-MX8Li	\$61.00
<b>NIPPON</b>				
	NBHT-2065	4.8 Volt / 800mAh	BCS-BHT2065MH	\$33.00

BARCODE	BATTERIES MFG/MODEL	VOLTAGE / CAPACITY	R&D PART	LIST PRICE
<b>NORAND</b>				
RT1100		7.2 Volt / 600mAh	BCS-10	\$17.00
RT1101		7.2 Volt / 1100mAh	BCS-10MH	\$26.00

<b>METROLOGIC</b>				
MS5500		3.7 Volt / 750mAh	BCS-MS5500	\$14.00
SP5700		3.7 Volt / 2000mAh	BCS-SP5700	\$19.00

<b>PSC/PERCON</b>				
POWERSCAN 700BT		3.7 Volt / 2300mAh	BCS-7000Li	\$56.00
Falcon 310, 320, 325, 330, 335, 340, 345		3.6 Volt / 1000mAh	BCS-16	\$16.00
Falcon 310, 320, 325, 330, 335, 340, 346		3.6 Volt / 1600mAh	BCS-16MH	\$28.00
4400		3.7 Volt / 2150mAh	BCS-4400Li	\$41.00

<b>PSION</b>				
7030		7.2 Volt / 2500mAh	BCS-7030	\$55.00
7035		7.4 Volt / 2300mAh	BCS-7035	\$84.00
7525, G1, G2		3.7 Volt / 3400mAh	BCS-7525Li	\$91.00
7527		3.7 Volt / 4400mAh	BCS-7527Li	\$91.00
7530G2		11.1 Volt / 2300mAh	BCS-7530	\$93.00
7535		7.4 Volt / 1900mAh	BCS-7535Li	\$84.00
WORKABOUT MX		2.4 Volt / 1600mAh	BCS-33MH	\$28.00
WORKABOUT MX (Memory)		3 Volt / 60mAh	CR1620	\$3.25

<b>TELXON</b>				
PTC-860		4.8 Volt / 1400mAh	BCS-11	\$26.00
PTC-960		4.8 Volt / 900mAh	BCS-5MH	\$21.00
PTC-960C		7.2 Volt / 600mAh	BCS-22	\$26.00

<b>SYMBOL</b>				
P360, P370, P460, P470		3.7 Volt / 1600mAh	BCS-25Li	\$28.00
LDT3500, 3800, 3805, LRT3800, 6800		6 Volt / 900mAh	BCS-4MH	\$47.00
LS3478		3.7 Volt / 2300mAh	BCS-LS3478	\$44.00
LS4070, 4071, 4074, 4075		6 Volt / 750mAh	BCS-LS4074	\$24.00
LS4278		3.6 Volt / 700mAh	BCS-LS42784MH	\$17.00
MC35		7.4 Volt / 1550mAh	BCS-35Li	\$41.00
MC50		3.7 Volt / 3800mAh	BCS-MC50Li	\$68.00
MC70		3.7 Volt / 3600mAh	BCS-MC70LI	\$38.00
MC70 Memeory		2.4 Volts / 22mAh	BCS-MC70-M	\$19.00
MC75		3.7 Volt / 3600mAh	BCS-MC75	\$82.00
MC1000		3.7 Volt / 1900mAh	BCS-MC1000	\$41.00
MC3000 IMAGER		3.7 Volt / 4600mAh	BCS-3000IMG	\$59.00
MC3000 LASER		3.7 Volt / 2740mAh	BCS-3000LSR	\$55.00
MC9000		7.4 Volt / 2300mAh	BCS-9000	\$70.00
MC9000 SHORT BATT		7.4 Volt / 1550mAh	BCS-9000SH	\$70.00
PDT3100, 3110, 3120, 3124, 3140, 3142, 3146		6 Volt / 750mAh	BCS-1MH	\$31.00
PDT6100		3.6 Volt / 1800mAh	BCS-39MHGR	\$31.00
PDT6800, 6810		6 Volt / 900mAh	BCS-4MH	\$47.00
PDT6840, 6842, 6846 W/ 3CONTACTS		7.4 Volt / 2300mAh	BCS-4LiCNT	\$83.00
PDT7500 Series Scanners		7.4 Volt / 1550mAh	BCS-35Li	\$49.00
PDT8000, 8037, 8046, 8056		7.4 Volt / 1200mAh	BCS-8000	\$48.00
PDT8100		3.7 Volt / 1950mAh	BCS-41Li	\$26.00
PDT8100		3.7 Volt / 1700mAh	BCS-28Li	\$28.00
PDT8100		3.7 Volt / 3800mAh	BCS-28Li-HC	\$59.00

BARCODE SYMBOL...continued	BATTERIES MFG/MODEL	VOLTAGE / CAPACITY	R&D PART	LIST PRICE
	PS3050	3.7 Volt / 2300mAh	BCS-PS3050	\$48.00
	SPT1800	3.7 Volt / 1700mAh	PDA-62Li	\$44.00
	SPT1800	3.7 Volt / 3100mAh	PDA-62LiXT	\$70.00
	WSS1000, 1040, 1060, 2280	3.7 Volt / 2300mAh	BCS-34Li	\$45.00
	WT4000, 4070, 4090	3.7 Volt / 2500mAh	BCS-4090	\$55.00

<b>UNITECH</b>				
	PA960	7.4 Volt / 1700mAh	BCS-PA960	\$40.00

<b>ZEBRA</b>				
	ENCORE 2	7.2 Volt / 1100mAh	BCS-ENC2	\$48.00
	ENCORE 3	7.2 Volt / 2400mAh	BCS-ENC3MH	\$68.00
	3N	7.2 Volt / 2400mAh	BCS-ENC3MH	\$69.00
	RW220	7.4 Volt / 2300mAh	BCS-RW220	\$73.00
	RW420	7.4 Volt / 4600mAh	BCS-RW420	\$97.00
	QL320	7.4 Volt / 2300mAh	BCS-QL320	\$56.00
	QL420	7.4 Volt / 4600mAh	BCS-QL420	\$79.00

# PRIMARY BATTERIES

## ENERGIZER INDUSTRIAL ALKALINE / LITHIUM

TYPE	SIZE	DESCRIPTION	R&D PART	1-100	100+	PACKAGING
E22, EN22	9V	9 Volt Alkaline	9V	\$1.75 ea	\$1.66 ea	12 / box
L522	9V	9 Volt Lithium	5868	\$5.95 ea	\$5.70 ea	10 / box
E91, EN91	AA	1.5 Volt AA Alkaline	AA	\$0.55 ea	\$0.50 ea	24 / box
L91	AA	1.5 Volt AA Lithium	L91	\$4.25 ea	\$3.25 ea	2 / card
E92, EN92	AAA	1.5 Volt AAA Alkaline	AAA	\$0.60 ea	\$0.55 ea	24 / box
L92	AAA	1.5 Volt AAA Lithium	L92	\$4.25 ea	\$3.75 ea	2 / card
E96	AAAA	1.5Volt AAAA Alkaline	AAAA	\$2.00 ea	\$1.50 ea	2 / card
E93, EN93	C	1.5 Volt C Alkaline	C	\$0.75 ea	\$0.70 ea	12 / box
E95, EN95	D	1.5 Volt D Alkaline	D	\$0.90 ea	\$0.85 ea	12 / box
E539, EN539	J	6 Volt J Alkaline	J	\$4.95 ea	\$4.20 ea	1 / card
E90, EN90	N	1.5 Volt N Alkaline	N	\$1.70 ea	\$1.55 ea	2 / card
EN529	LANTERN	6V Spring Terminal	EN529	\$10.00 ea		Each
EN715	LANTERN	7.5V Screw Terminal	EN715	\$45.00 ea		Each

## DURACELL PROCELL ALKALINE / ZINC AIR

PC1300	D	1.5 Volt D Alkaline	PC1300	\$0.90 ea	\$0.85 ea	12 / box
PC1400	C	1.5 Volt C Alkaline	PC1400	\$0.85 ea	\$0.80 ea	12 / box
PC1500	AA	1.5 Volt AA Alkaline	PC1500	\$0.55 ea	\$0.50 ea	24 / box
PC1604	9V	9 Volt Alkaline	PC1604	\$1.85 ea	\$1.80 ea	12 / box
PC2400	AAA	1.5 Volt AAA Alkaline	PC2400	\$0.65 ea	\$0.60 ea	24 / box
PC7K67	J	6 Volt J Alkaline	PC7K67	\$4.95 ea	\$4.50 ea	1 / card
PC9100	N	1.5 Volt N Alkaline	PC9100	\$1.60 ea	\$1.45 ea	2 / card
DA146 (EV146)	9V	9 Volt Zinc Air	DA146	\$6.50	\$6.50	Each

## DURACELL, EVEREADY, RAYOVAC

NEDA #	VOLTAGE	L x W x H (in)	CONTACT	R&D PART	LIST PRICE
918CD	6 Volt	5.00 x 5.37 x 2.87	Screw	EV131	\$16.00
722	300 Volt	2.65 x 2.08 x 3.78	Socket	EV493	\$85.00
908CD	6 Volt	4.53 x 2.69 x 2.69	Spring	EV190	\$9.00
908/941	6 Volt	2.63 x 2.63 x 4.41	Spring	EV509	\$7.50
915/942	6 Volt	2.69 x 2.69x4.31	Screw	EV510S	\$9.00
918A	6 Volt	5.00 x 5.37 x 2.87	Screw	EV521	\$30.00
1604A	9 Volt	1.91 x 1.04 x 0.69	Snap	EV522	\$1.85
RPX21	4.5 Volt	0.67 Diameter x 1.97	Pressure	EV523	\$8.25
915A	6 Volt	4.41 x 2.69 x 2.69	Screw	EV528	\$30.00
908A	6 Volt	4.53 x 2.69 x 2.69	Spring	EV529	\$10.50
RPX19	4.5 Volt	0.67 Diameter x 2.30	Snap	EV531	\$12.00
RPX24	3 Volt	0.67 Diameter x 1.67	Pressure	EV532	\$12.00
RPX28	6 Volt	0.52 Diameter x 1.00	Pressure	EV544	\$14.00
-	1.5 Volt	0.46 Diameter x .021	Pressure	EV675	\$2.10
700	1.5 Volt	4.03 x 2.63 x 1.33	Screw	EV711	\$18.00
903/903AC	7.5 Volt	7.25 x 4.06 x 3.75	Screw	EV715	\$36.00
918	6 Volt	5.38 x 2.88 x 4.93	Screw	EV731	\$21.50
926	12 Volt	4.94 x 5.37 x 2.87	Screw	EV732	\$15.00
908/944	6 Volt	4.53 x 2.69 x 2.69	Spring	EV1209	\$7.50
918D/928	6 Volt	5.00 x 5.37 x 2.87	Screw	EV1231	\$16.00



# PRIMARY BATTERIES

## DURACELL, EVEREADY, EXELL

TYPE	CROSS REFERENCE	VOLTAGE	R&D PART	LIST PRICE
A132	E132, EN132A, TR132, 2/LR50, PC132A	3 Volt	PC132A	\$8.50
A133	E133, TR133, EN133A, 3/LR50, PC133A	4.5 Volt	PC133A	\$8.25
A134	E134, TR134, EN134A, 4/LR50, PC134A	6 Volt	PC134A	\$14.00
A135	E135, TR135, EN135A, 5/LR50, PC135A	7.5 Volt	PC135A	\$15.50
A136	E136, TR136, EN136A, 6/LR50, PC136A	9 Volt	PC136A	\$18.00
A164	E164, PX32, EN164A, 4/LR52, PC164A	6 Volt	PC164A	\$9.85
A165	E165, TR165, EN165A, 5/LR52, PC165A	7.5 Volt	PC165A	\$9.85
A175	TR175, EN175A, 5/LR44, PC175A	7.5 Volt	PC175A	\$9.85
A177	EN177A, 7/LR44, PC177A	10.5 Volt	PC177A	\$12.00
640A	E640, PX32PX, EN640A, LR52, PC640A	1.5 Volt	PC640A	\$4.25
A14PX	Alkaline - EPX14, PX14V14PX, 2MR9	3 Volt	PX14A	\$3.25
S14PX	Silver Oxide - EPX14, PX14V14PX, 2MR9	3 Volt	PX14S	\$4.95
A19PX/531	PX19, V19PX, EVEREADY 531	4.5 Volt	PX19A	\$12.00
A21PX/523	V21PX, EVEREADY 523	4.5 Volt	PC133A	\$8.25
S523PX	EPX23, PX23, 4MR43	6 Volt	PX23S	\$4.95
A24PX/532	V24PX, EVEREADY 532	3 Volt	PX24A	\$12.00
S27PX	EPX27, PX27, 4MR43	6 Volt	PX27S	\$4.95
28A	EV544, PX28, K28, 4LR44, 4034, A28PX	6 Volt	PX28A	\$9.00
28L	EV544, PX28, K28, 4LR44, 4034, A28PX	6 Volt	PX28L	\$12.00
A32PX	SAME AS PC164A	6 Volt	PX32A	\$9.85
625A	EPX625, PX625A, A625PX	1.5 Volt	PX625A	\$1.80
640A	EPX640, PX640A, A640PX	1.5 Volt	PX640A	\$4.25
675A	PX76, PX675A, A675PX, PX76A675PK	1.5 Volt	PX675A	\$1.25
A23	GP23A, A23, 23A, MN21, VINNIC L1028	12 Volt	MN21	\$4.25
840/844	RAYOVAC 840, 844, EXCELL 840	4.5 Volt	840/844	\$18.00

# PRIMARY BUTTON CELLS

## SILVER OXIDE 1.55 VOLTS PER CELL

R&D, EVEREADY	LIST PRICE	DIMENSION (mm)	VINNIC	RAYOVAC	DURACELL	RENATA	VARTA	MAXELL	PANASONIC	OTHERS
EV337	\$1.60	4.8 x 1.65	-	-	D337	-	V357	SR416SW	-	-
EV357	\$1.60	11.6 x 5.4	S1154	RW42	D357, D303	9, 7	V357	SR44W	WL14, WS14	SG13, GP76
EV362	\$1.60	7.9 x 2.1	S721	RW310/410	D362	19	V362	SR721W	-	SG11, GP62
EV364	\$1.60	6.8 x 2.1	S621	RW320	D364	31	V364	SR621SW	-	SG1, GP64
EV370, EV371,	\$1.60	4.5 x 2.1	-	RW315	-	-	V370, 371	SR920SW	SP371	SR69
EV376, EV377	\$1.60	6.8 x 2.6	S626	RW329	-	37	V377	SR626W	-	SG4, GP77
EV379	\$1.60	5.8 x 2.1	S521	-	D379	-	V379	SR521SW	-	SG521
EV386	\$1.60	11.6 x 4.2	S1142	RW44	D386, D301	1, 6	V386	SR43W	WL11, WS11	SG12, GP86
EV389	\$1.60	11.6 x 3.1	S1131	RW49	D389, D390	11, 17	V390	SR1130W	WL10	SG10, GP90
EV391	\$1.60	11.6 x 2.1	S1121	RW40	D391	23, 34	V391	SR1120SW	WL5	SG8, GP91
EV392, EV384	\$1.60	7.9 x 3.6	S736	RW47	D392, D384	2, 13	V392	SR41W	WL1, WS1	SG3, GP92
EV393	\$1.60	7.9 x 5.4	S754	RW48	D393	15, 16	V393	SR754W	WL6, WS6	SG5, GP93
EV394	\$1.60	9.5 x 3.6	S936	RW33	-	27	V394	SR936W	-	SG9, GP94
EV395	\$1.60	9.5 x 2.6	S926	RW413	-	25, 35	V399	SR927W	-	SG7, GP95
EV396, EV397	\$1.60	7.9 x 2.6	S726	RW411	D396, D397	26, 29	V397	SR726SW	-	SG2, GP96

## ALKALINE MANGANESE 1.50 VOLTS PER CELL

R&D, EVEREADY	LIST PRICE	DIMENSION (mm)	VINNIC	RAYOVAC	DURACELL	RENATA	VARTA	MAXELL	PANASONIC	OTHERS
A76	\$1.60	11.6 x 5.4	L1154, L1325	RW82	D76A	LR44	4276	LR44	LR44	AG13, 76A
EV186	\$1.60	11.6 x 4.2	L1142	RW84	D186A	LR43	4278	LR43	LR43	AG12, 86A
EV189	\$1.60	11.6 x 3.1	L1131	RW89	D189A	LR113	4274, V10	LR1130	LR113	AG10 89A
EV191	\$1.60	11.6 x 2.1	L1121	-	-	LR112	V8GA	LR1120	LR54, LR112	AG8, 91A
EV192	\$1.60	7.9 x 3.6	L736	-	-	LR41	V3GA	LR41	-	AG3, 92A
EV193	\$1.60	7.9 x 5.4	L754	-	-	-	-	-	-	AG5
EV196	\$1.60	7.9 x 2.6	L726	-	-	-	-	-	-	AG2
625A	\$1.80	-	-	-	PX625A	-	-	-	-	A625PX
640A	\$4.25	-	-	-	PX640A	-	-	-	-	A640PX
675A	\$1.25	-	-	-	PX675A	-	-	-	-	A675PX
BT-2	\$6.00	Quick Tester for Alkaline Primary Cells								

## HEARING AID BATTERIES

### ZINC AIR 1.4 VOLTS PER CELL 6 BATTERIES PER CARD

R&D PART NUMBER	ZA5	ZA10	ZA13	ZA312	ZA675
PRICE PER CARD	\$7.25	\$3.75	\$3.75	\$3.75	\$3.75
Color Code	Red	Yellow	Orange	Brown	Blue
AARP	-	B0104	B0134	B3124	B6754
Activair	5HP	10HP	13HP	312HP	675HP
Beltone	B7PA	B20PA	B26PA	B347PA	B900PA
Duracell	-	DA10H/230	DA13H	DA312H	DA675H
Energizer	-	AC230E	AC13E	AC312E	AC675E
Miracle Ear	ME5Z	ME10Z	ME8Z	ME7Z	ME9Z
Panasonic	PR5PA	PR10PA	PR13PA	PR312PA	PR675PA
Rayovac	-	L10ZA	L13ZA	L312ZA	L675ZA
Rayovac - Proline	5A	10A	13A	312A	675A
Renata	ZA5	ZA10	ZA13	ZA312	ZA675
Siemens	5SA	10SA	13SA	312SA	675SA
Starkey	S5A	S10A	S13A	S312A	S675A
Varta	V5AT	V10AT	V13AT	V312AT	V675AT

Primary

# LITHIUM BATTERIES

## DURACELL, EXCELL

1/3N, DL1/3N, 2L76	3 Volt / 160mAh	11.6 Diameter x 10.8	DL1/3N	\$3.00
123A, DL123A	3 Volt / 1700mAh	17.0 Diameter x 34.5	DL123A	\$6.00
223A, DL223A	6 Volt / 1400mAh	36.0 x 35.0 x 19.5	DL223A	\$12.00
245, DL245B	6 Volt / 1500mAh	45.0 x 34.0 x 17.0	2CR5	\$18.00
CR2, DL2CR2	3 Volt / 750mAh	15.6 Diameter x 27.0	CR2	\$9.50
2/3A, DL2/3A	3 Volt / 1200mAh	17.0 Diameter x 33.5	5062	\$5.00
CR-V3, DL2CRV3	3 Volt / 3300mAh	29.0 x 14.5 x 52.0	CR-V3	\$20.00
DL1616	3 Volt / 45mAh	16.0 Diameter x 1.6	DL1616	\$3.25
DL1620	3 Volt / 75mAh	16.0 Diameter x 2.0	DL1620	\$3.25
DL2016	3 Volt / 75mAh	20.0 Diameter x 1.6	DL2016	\$3.25
DL2025	3 Volt / 150mAh	20.0 Diameter x 2.5	DL2025	\$3.25
DL2032	3 Volt / 190mAh	20.0 Diameter x 3.2	DL2032	\$3.25
DL2430	3 Volt / 280mAh	24.5 Diameter x 3.0	DL2430	\$4.25
DL2450	3 Volt / 560mAh	24.5 Diameter x 5.0	DL2450	\$4.25
PL123, PL123A	3 Volt / 1400mAh	17.0 Diameter x 34.5	DL123A	\$6.00
PX28L, 28LB, L28PX	6 Volt / 160mAh	13.0 Diameter x 25.2	PX28L	\$12.00

## EAGLE PICHER KEEPER II - PRISMATIC

LTC-3PN	3.5 Volt / 350mAh	15.22 x 16.50 x 6.35	LTC-3PN	\$15.00
LTC-3PN-S2	3.5 Volt / 350mAh	15.22 x 16.50 x 6.35	LTC-3PN-S2	\$18.00
LTC-3PN-S4	3.5 Volt / 350mAh	15.22 x 16.50 x 6.35	LTC-3PN-S4	\$15.00
LTC-7P	3.5 Volt / 750mAh	30.48 x 17.78 x 8.89	5359	\$25.00
LTC-7PMP	3.5 Volt / 750mAh	38.10 x 30.50 x 8.40	5939	\$28.00
LTC-7PN	3.5 Volt / 750mAh	25.40 x 16.51 x 6.35	LTC-7PN	\$18.00
LTC-7PN-S2	3.5 Volt / 750mAh	25.40 x 16.51 x 6.35	6017	\$18.00
LTC-7PN-S4	3.5 Volt / 750mAh	25.40 x 16.51 x 6.35	LTC-7PN-S4	\$18.00

## ELECTROCHEM

BCX85C-LMS	3.9 Volt / 7000mAh	1.09 Diameter x 1.97	5580	\$98.00
BCX85-3B50	3.9 Volt / 1000mAh	1.01 Diameter x .32	5727	\$34.50
CSC93-3B24	3.9 Volt / 2000mAh	.55 Diameter x 1.97	5806	\$57.00

## ENERGIZER

2L76	3 Volt / 160mAh	11.6 Diameter x 10.8	CR1/3N	\$3.00
ELCRV3	3 Volt / 3300mAh	29.0 x 14.5 x 52.0	CR-V3	\$20.00
EL123, EL123APVP	3 Volt / 1500mAh	17.0 Diameter x 34.5	5517	\$5.25
EL1CR2	3 Volt / 750mAh	15.6 Diameter x 27.0	CR2	\$9.50
EL223	6 Volt / 1400mAh	36.0 x 35.0 x 19.5	CR-P2	\$14.00
EL2CR5	6 Volt / 1500mAh	45.0 x 34.0 x 17.0	2CR5	\$18.00
L522, L522MJ	9 Volt / 1200mAh	34.4 x 48.5 x 26.5	L522	\$6.25
L544	6 Volt / 160mAh	13.0 Diameter x 25.2	PX28L	\$12.00
L91, L91VP (AA)	1.5 Volt / 2900mAh	14.5 Diameter x 50.5	L91	\$4.25
L92 (AAA)	1.5 Volt / 1500mAh	10.5 Diameter x 44.5	L92	\$4.25
CR1025, ECR1025BP	3 Volt / 30mAh	10.0 Diameter x 2.5	ECR1025	\$1.80
CR1216, ECR1216BP	3 Volt / 34mAh	12.5 Diameter x 1.6	ECR1216	\$1.80
CR1220	3 Volt / 40mAh	12.5 Diameter x 2.0	ECR1220	\$1.80
CR1616	3 Volt / 55mAh	16.0 Diameter x 1.6	ECR1616	\$1.80
CR1620	3 Volt / 79mAh	16.0 Diameter x 2.0	ECR1620	\$1.80
CR1130	3 Volt / 70mAh	11.6 Diameter x 3.0	CR1130	\$3.25
CR1632	3 Volt / 130mAh	16.0 Diameter x 3.2	ECR1632	\$1.80
CR2012	3 Volt / 58mAh	20.0 Diameter x 1.2	ECR2012	\$1.80
CR2016	3 Volt / 90mAh	20.0 Diameter x 1.6	ECR2016	\$1.80
CR2025	3 Volt / 163mAh	20.0 Diameter x 2.5	ECR2025	\$1.80
CR2032	3 Volt / 240mAh	20.0 Diameter x 3.2	ECR2032	\$1.80
CR2430	3 Volt / 290mAh	24.5 Diameter x 3.0	ECR2430	\$1.95
CR2450	3 Volt / 320mAh	24.5 Diameter x 5.0	ECR2450	\$2.25

# LITHIUM BATTERIES

## PANASONIC

2CR-5	6 Volt / 1400mAh	17.0 x 34.0 x 45.0	2CR5	\$18.00
BR1220	3 Volt / 35mAh	12.5 Diameter x 2.0	BR1220	\$1.80
BR1225	3 Volt / 48mAh	12.5 Diameter x 2.5	BR1225	\$1.85
BR1616	3 Volt / 48mAh	16.0 Diameter x 2.0	BR1616	\$2.25
BR2032	3 Volt / 190mAh	20.0 Diameter x 3.2	BR2032	\$2.25
BR2325	3 Volt / 165mAh	23.0 Diameter x 2.5	BR2325	\$2.50
BR2330	3 Volt / 250mAh	23.0 Diameter x 3.0	BR2330	\$3.25
BR3032	3 Volt / 500mAh	30.0 Diameter x 3.0	BR3032	\$4.25
BR-2/3A	3 Volt / 1200mAh	17.0 Diameter x 33.5	5062	\$5.00
BR-2/3AT2SP	3 Volt / 1200mAh	17.0 x 33.5 - With Solder Tabs	5062-T	\$6.50
BR-2/3AE5SP	3 Volt / 1200mAh	17.0 x 33.5 - 1 Pin (+) 1 Pin (-)	5062-P	\$6.50
BR-2/3AE2SP	3 Volt / 1200mAh	17.0 x 33.5 - 2 Pins (+) 1 Pin (-)	5062-P2	\$6.50
BR-425	3 Volt / 25mAh	4.2 Diameter x 25.9	BR425	\$9.00
BR-435	3 Volt / 50mAh	4.2 Diameter x 35.9	BR435	\$9.00
BR-A	3 Volt / 1800mAh	17.0 Diameter x 45.5	BR-A	\$12.00
BR-C	3 Volt / 5000mAh	26.0 Diameter x 50.0	BR-C	\$14.00
BR-E3C3BCA	6 Volt / 1200mAh	22.0 x 39.0 x 41.0	BR-E3	\$22.00
BR-P2PE	6 Volt / 1200mAh	19.5 x 33.9 x 36.0	BR-P2	\$18.00
CR-123A	3 Volt / 1400mAh	17.0 Diameter x 34.5	5517	\$5.25
CR-P2	6 Volt / 1500mAh	36.0 x 35.0 x 19.5	CR-P2	\$12.00
CR-V3	3 Volt / 3300mAh	29.0 x 14.5 x 52.0	CR-V3	\$20.00
CR1025	3 Volt / 30mAh	10.0 Diameter x 2.5	CR1025P	\$1.80
CR1216	3 Volt / 34mAh	12.5 Diameter x 1.6	CR1216P	\$1.80
CR1220	3 Volt / 40mAh	12.5 Diameter x 2.0	CR1220P	\$1.80
CR1612	3 Volt / 40mAh	16.0 Diameter x 1.2	CR1612P	\$4.25
CR1616	3 Volt / 55mAh	16.0 Diameter x 1.6	CR1616P	\$1.80
CR1620	3 Volt / 79mAh	16.0 Diameter x 2.0	CR1620P	\$1.80
CR1632	3 Volt / 130mAh	16.0 Diameter x 3.2	CR1632P	\$1.80
CR2012	3 Volt / 58mAh	20.0 Diameter x 1.2	CR2012P	\$1.80
CR2016	3 Volt / 90mAh	20.0 Diameter x 1.6	CR2016P	\$1.80
CR2025	3 Volt / 163mAh	20.0 Diameter x 2.5	CR2025P	\$1.80
CR2032	3 Volt / 240mAh	20.0 Diameter x 3.2	CR2032P	\$1.80
CR2330	3 Volt / 250mAh	23.0 Diameter x 3.0	CR2330	\$3.25
CR2335	3 Volt / 300mAh	23.0 Diameter x 3.5	CR2335	\$3.25
CR2354	3 Volt / 560mAh	23.0 Diameter x 5.4	CR2354	\$3.25
CR2412	3 Volt / 100mAh	24.5 Diameter x 1.2	CR2412	\$6.00
CR2450	3 Volt / 560mAh	24.5 Diameter x 5.0	CR2450P	\$2.25
CR2477	3 Volt / 1000mAh	24.5 Diameter x 7.7	CR2477P	\$3.25
CR3032	3 Volt / 500mAh	30.0 Diameter x 3.0	CR3032	\$4.25

# LITHIUM BATTERIES

## PANASONIC - PCB TERMINAL TYPE

PANASONIC #	TAB DESCRIPTION	R&D PART	LIST PRICE
BR1225-1HC	2 Pin, Horizontal Mount, Through Hole (With Insulation Wrap)	BR1225-1HC	\$5.75
BR1225-1VC	2 Pin, Vertical Mount, Through Hole (With Insulation Wrap)	BR1225-1VC	\$5.75
BR1225A/FA*	2 Pin, Vertical Mount, Through Hole (With Insulation Wrap)	BR1225A/FA	\$5.75
BR1225A/HB*	2 Pin, Horizontal Mount, Through Hole (With Insulation Wrap)	BR1225A/HB	\$5.75
BR1632-1HF	2 Pin, Horizontal Mount, Through Hole (With Insulation Wrap)	BR1632-1HF	\$5.75
BR1632A/FA*	2 Pin, Flat Mount (With Insulation Wrap)	BR1632A/FA	\$5.75
BR1632A/GA*	2 Pin, Horizontal Mount, Through Hole (Without Insulation Wrap)	BR1632A/GA	\$5.75

# LITHIUM BATTERIES

## PANASONIC - PCB TERMINAL TYPE...continued from previous page

PANASONIC #	TAB DESCRIPTION	R&D PART	LIST PRICE
BR1632A/HA*	2 Pin, Horizontal Mount, Through Hole (With Insulation Wrap)	BR1632A/HA	\$5.75
BR1632A/VA*	2 Pin, Vertical Mount, Through Hole (With Insulation Wrap)	BR1632A/VA	\$5.75
BR2032-1F2	2 Pin, Flat Mount (With Insulation Wrap)	BR2032-1F2	\$5.75
BR2032-1HE	2 Pin, Horizontal Mount, Through Hole (Without Insulation Wrap)	BR2032-1HE	\$5.75
BR2032-1VB	2 Pin, Vertical Mount, Through Hole (Without Insulation Wrap)	BR2032-1VB	\$5.75
BR2325-1HB	2 Pin, Horizontal Mount, Through Hole (Without Insulation Wrap)	BR2325-1HB	\$5.75
BR2325-1HC	2 Pin, Horizontal Mount, Through Hole (With Insulation Wrap)	BR2325-1HC	\$5.75
BR2325-1HG	2 Pin, Horizontal Mount, Through Hole (Without Insulation Wrap)	BR2325-1HG	\$5.75
BR2325-1VC	2 Pin, Vertical Mount, Through Hole (Without Insulation Wrap)	BR2325-1VC	\$5.75
BR2325-1VG	2 Pin, Vertical Mount, Through Hole (Without Insulation Wrap)	BR2325-1VG	\$5.75
BR2325-2HC	2 Pin, Horizontal Mount, Through Hole (With Insulation Wrap)	BR2325-2HC	\$5.75
BR2330A/FA*	2 Pin, Flat Mount (With Insulation Wrap)	BR2330A/FA	\$5.75
BR2330A/HD*	2 Pin, Horizontal Mount, Through Hole (With Insulation Wrap)	BR2330A/HD	\$5.75
BR2330A/VA*	2 Pin, Vertical Mount, Through Hole (With Insulation Wrap)	BR2330A/VA	\$5.75
BR2330A/GAE*	3 Pin, Horizontal Mount, Through Hole (Without Insulation Wrap)	BR2330A/GAE	\$5.75
BR2330-1HE	2 Pin, Horizontal Mount, Through Hole (Without Insulation Wrap)	BR2330-1HE	\$5.75
BR2330-1VC	2 Pin, Vertical Mount, Through Hole (With Insulation Wrap)	BR2330-1VC	\$5.75
BR2477A/FB*	2 Pin, Flat Mount (With Insulation Wrap)	BR2477A/FB	\$6.25
BR2477A/HB*	2 Pin, Horizontal Mount, Through Hole (With Insulation Wrap)	BR2477A/HB	\$6.50
BR2477A/VA*	2 Pin, Vertical Mount, Through Hole (With Insulation Wrap)	BR2477A/VA	\$6.75
BR2477A/GAE*	2 Pin, Horizontal Mount, Through Hole (With Insulation Wrap)	BR2477A/GAE	\$6.75
CR2016-1F2	2 Pin, Flat Mount (With Insulation Wrap)	CR2016-1F2	\$5.75
CR2477-1HF	2 Pin, Horizontal Mount, Through Hole (With Insulation Wrap)	CR2477-1HF	\$7.50
ML614S/F9F	2 Pin, Flat / Surface Mount (Without Insulation Wrap)	ML614S/F9F	\$9.50
ML621S/F9D	2 Pin, Flat / Surface Mount (Without Insulation Wrap)	ML621S/F9D	\$9.50
ML920S/F9D	2 Pin, Flat / Surface Mount (Without Insulation Wrap)	ML920S/F9D	\$9.50
ML1220/F1A	2 Pin, Flat / Surface Mount (With Insulation Wrap)	ML1220/F1A	\$9.50
ML1220/V1A	2 Pin, Vertical Mount Through Hole (With Insulation Wrap)	ML1220/V1A	\$9.50
ML2020/G1A	3 Pin, Horizontal Mount Through Hole (With Insulation Wrap)	ML2020/G1A	\$9.50
ML2020/V1A	2 Pin, Vertical Mount Through Hole (With Insulation Wrap)	ML2020/V1A	\$9.50
ML2020/H1C	2 Pin, Horizontal Mount Through Hole (With Insulation Wrap)	ML2020/H1C	\$9.50
NBL621/F9D	2 Pin, Flat Surface Mount (Without Insulation Wrap)	NBL621/F9D	\$9.50
VL621-F9D	2 Pin, Flat Mount (Without Insulation Wrap)	VL621-F9D	\$9.50
VL1216-1F5U	2 Pin, Flat Mount (Without Insulation Wrap)	VL1216-1F5U	\$9.50
VL1220-1HF	2 Pin, Horizontal Mount Through Hole (With Insulation Wrap)	VL1220-1HF	\$9.50
VL1220-1VC	2 Pin, Vertical Mount Through Hole (With Insulation Wrap)	VL1220-1VC	\$9.50
VL2020-1HF	2 Pin, Horizontal Mount Through Hole (With Insulation Wrap)	VL2020-1HF	\$9.50
VL2020-1VC	2 Pin, Vertical Mount Through Hole (With Insulation Wrap)	VL2020-1VC	\$9.50
VL2320-1F2	2 Pin, Flat Surface Mount (Without Insulation Wrap)	VL2320-1F2	\$9.50
VL2320-1HF	2 Pin, Horizontal Mount Through Hole (With Insulation Wrap)	VL2320-1HF	\$9.50
VL2320-1VC	2 Pin, Vertical Mount Through Hole (With Insulation Wrap)	VL2320-1VC	\$9.50
VL2330-1HF	2 Pin, Horizontal Mount Through Hole (With Insulation Wrap)	VL2330-1HF	\$12.00
VL2330-1VC	2 Pin, Vertical Mount Through Hole (With Insulation Wrap)	VL2330-1VC	\$12.00
VL3032-1GUF	3 Pin, Horizontal Mount Through Hole (With Insulation Wrap)	VL3032-1GUF	\$15.00
VL3032-1F2	2 Pin, Flat Mount Through Hole (With Insulation Wrap)	VL3032-1F2	\$15.00

# LITHIUM BATTERIES

## RENATA COIN CELLS WITH PC PINS

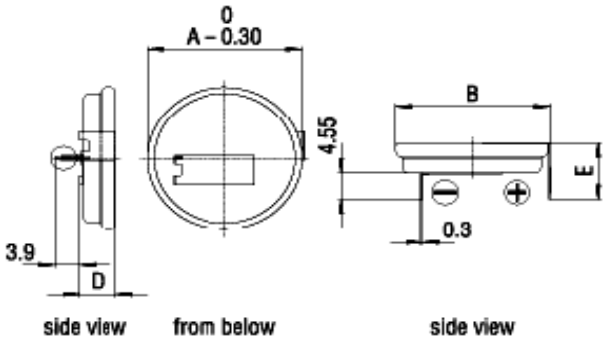
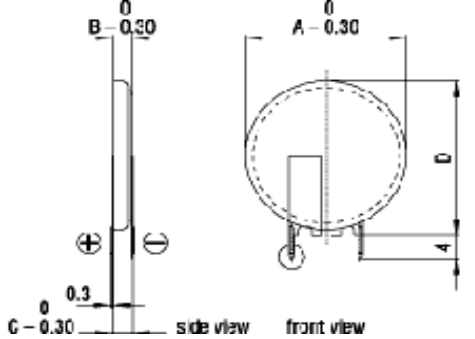
PART NUMBER	VOLTAGE/CAPACITY	LIST PRICE	CONFIGURATION
CR1216FH	3 Volt / 29mAh	\$4.50	<b>FH Suffix = Two Pins Horizontal</b> 
CR1220FH	3 Volt / 35mAh	\$4.50	
CR1225FH	3 Volt / 38mAh	\$4.50	
CR1616FH	3 Volt / 45mAh	\$4.50	
CR1620FH	3 Volt / 75mAh	\$4.50	
CR1632FH	3 Volt / 125mAh	\$4.50	
CR1632FH1	3 Volt / 125mAh	\$4.50	
CR2016FH	3 Volt / 75mAh	\$4.50	
CR2016FH1	3 Volt / 75mAh	\$4.50	
CR2025FH	3 Volt / 150mAh	\$4.50	
CR2025FH1	3 Volt / 150mAh	\$4.50	
CR2032FH	3 Volt / 190mAh	\$4.50	
CR2030FH	3 Volt / 255mAh	\$4.50	
CR2032FHO	3 Volt / 190mAh	\$4.50	
CR2032FH1	3 Volt / 190mAh	\$4.50	
CR2032FH2	3 Volt / 190mAh	\$4.50	
CR2325FH	3 Volt / 165mAh	\$4.50	
CR2430FH	3 Volt / 280mAh	\$4.50	
CR2430FH1	3 Volt / 280mAh	\$4.50	
CR2450NFH	3 Volt / 560mAh	\$4.50	
CR2477NFH	3 Volt / 1000mAh	\$4.50	
CR2016RH	3 Volt / 75mAh	\$4.50	
CR2025RH	3 Volt / 150mAh	\$4.50	
CR2032RH	3 Volt / 190mAh	\$4.50	
CR2325RH	3 Volt / 165mAh	\$4.50	
CR2430RH	3 Volt / 280mAh	\$4.50	
CR2430RH1	3 Volt / 280mAh	\$4.50	
CR2450NRH	3 Volt / 560mAh	\$4.50	
CR2450NRH	3 Volt / 560mAh	\$4.50	
CR2450NRH1	3 Volt / 560mAh	\$4.50	<b>FV Suffix = Two Pins Vertical</b> 
CR2477NRH	3 Volt / 1000mAh	\$4.50	
CR1025FV	3 Volt / 30mAh	\$4.50	
CR1220FV	3 Volt / 35mAh	\$4.50	
CR1225FV	3 Volt / 38mAh	\$4.50	
CR1616FV	3 Volt / 45mAh	\$4.50	
CR1620FV	3 Volt / 75mAh	\$4.50	
CR1632FV	3 Volt / 125mAh	\$4.50	
CR2032FV	3 Volt / 190mAh	\$4.50	
CR2320FV	3 Volt / 110mAh	\$4.50	
CR2325FV	3 Volt / 165mAh	\$4.50	
CR2430FV	3 Volt / 280mAh	\$4.50	
CR2450NFV	3 Volt / 560mAh	\$4.50	
CR2477NFV	3 Volt / 1000mAh	\$4.50	
CR2025RV	3 Volt / 150mAh	\$4.50	
CR2032RV	3 Volt / 190mAh	\$4.50	
CR2325RV	3 Volt / 165mAh	\$4.50	
CR2430RV	3 Volt / 280mAh	\$4.50	
CR2450NRV	3 Volt / 560mAh	\$4.50	
CR2477NRV	3 Volt / 1000mAh	\$4.50	

Primary

# LITHIUM BATTERIES

## RENATA

RENATA #	VOLTAGE/CAPACITY	DIMENSIONS LxWxH (mm)	R&D PART	LIST PRICE
CR1025	3 Volt / 30mAh	10.0 Diameter x 2.5	CR1025	\$3.25
CR1130	3 Volt / 70mAh	11.6 Diameter x 3.0	CR1130	\$3.25
CR1216	3 Volt / 29mAh	12.5 Diameter x 1.6	CR1216	\$3.25
CR1220	3 Volt / 38mAh	12.5 Diameter x 2.0	CR1220	\$3.25
CR1225	3 Volt / 38mAh	12.5 Diameter x 2.5	CR1225	\$3.25
CR1616	3 Volt / 45mAh	16.0 Diameter x 1.6	CR1616	\$3.25
CR1620	3 Volt / 75mAh	16.0 Diameter x 2.0	CR1620	\$3.25
CR1632	3 Volt / 125mAh	16.0 Diameter x 3.2	CR1632	\$3.25
CR2016	3 Volt / 75mAh	20.0 Diameter x 1.6	CR2016	\$3.25
CR2025	3 Volt / 150mAh	20.0 Diameter x 2.5	CR2025	\$3.25
CR2032	3 Volt / 190mAh	20.0 Diameter x 3.2	CR2032	\$3.25
CR2320	3 Volt / 110mAh	23.0 Diameter x 2.0	CR2320	\$3.25
CR2325	3 Volt / 165mAh	23.0 Diameter x 2.5	CR2325	\$3.25
CR2430	3 Volt / 280mAh	24.5 Diameter x 3.0	CR2430	\$4.25
CR2450N	3 Volt / 560mAh	24.5 Diameter x 5.0	CR2450	\$4.25
CR2477N	3 Volt / 1000mAh	24.5 Diameter x 7.7	CR2477N	\$4.25
250-00/1000-0	3 Volt / 280mAh	30.0 x 30.0 x 6.0	1000-0	\$18.00
1000-1	3 Volt / 950mAh	30.0 x 30.0 x 10.0	1000-1	\$20.00

## SAFT CYLINDRICAL

TYPE	VOLTAGE / CAPACITY	D x H (mm)	SIZE	CONTACT	R&D PART	LIST PRICE
LS 14250 BA	3.6 Volt / 1.2Ah	14.65 x 24.8	1/2AA	Pressure	5437	\$9.00
LS 14250 AX	3.6 Volt / 1.2Ah	14.65 x 24.8	1/2AA	Axial Leads	5466	\$9.00
LS 14250C BA	3.6 Volt / 1.2Ah	14.65 x 24.8	1/2AA	Pressure	5437	\$9.00
LS 14250C AX	3.6 Volt / 1.2Ah	14.65 x 24.8	1/2AA	Axial Leads	5466	\$9.00
LS 14500 BA	3.6 Volt / 2.6Ah	14.65 x 50.3	AA	Pressure	5231	\$9.00
LS 14500 AX	3.6 Volt / 2.6Ah	14.65 x 50.3	AA	Axial Leads	5084-A	\$9.00
LS 14500C BA	3.6 Volt / 2.6Ah	14.65 x 50.3	AA	Pressure	5231	\$9.00
LS 14500C AX	3.6 Volt / 2.6Ah	14.65 x 50.3	AA	Axial Leads	5084-A	\$9.00
LST 17330	3.6 Volt / 2.0Ah	16.50 x 33.4	2/3A	Pressure	LST17330	\$11.00
LS17500	3.6 Volt / 3.4Ah	17.13 x 50.9	A	Pressure	LS17500	\$10.00
LSH 14	3.6 Volt / 5.5Ah	26.0 x 50.4	C	Pressure	LSH14	\$22.00
LS 33600	3.6 Volt / 17.0Ah	33.4 x 60.2	D	Pressure	LS33600	\$24.00
LSH 20	3.6 Volt / 13.0Ah	33.4 x 33.4	D	Pressure	LSH20	\$28.00
LO 26 SX STS	3 Volt / 7.5Ah	34.20 x 59.3	D	Solder Tabs	LO26SX	\$14.00
LO 26 SHX	3 Volt / 7.5Ah	34.20 x 59.3	D	Solder Tabs	LO26SHX	\$14.00

## FDK, VARTA CYLINDRICAL

TYPE	VOLTAGE / CAPACITY	D x H (mm)	IEC	R&D PART	LIST PRICE
2CR5	6 Volt / 1400mAh	34 x 17 x 45	2CP3845	2CR5	\$18.00
CR 1/2AA	3 Volt / 950mAh	14.75 x 25.1	-	CR1/2AA	\$9.00
CR 2/3AA	3 Volt / 1350mAh	14.75 x 33.5	-	CR2/3AA	\$6.00
CR 2/3A	3 Volt / 1200mAh	17.0 x 33.5	-	5062	\$5.00
CR AA	3 Volt / 2000 mAh	14.75 x 50.5	-	CRAA	\$14.00
2CR-1/3N	6 Volt / 160mAh	13.0 x 25.2	2CR11108	PX28L	\$12.00
CR-1/3N	3 Volt / 160mAh	11.6 x 10.8	CR11108	CR1/3N	\$3.00
CR123A	3 Volt / 1500mAh	17.0 x 34.5	CR17345	5517	\$5.25
CR12600SE, CR2NP	3 Volt / 1500mAh	12.0 x 60.0	CR12600	CR12600SE	\$6.00
CR2NP	3 Volt / 1500mAh	12.0 x 60.0	CR12600	CR12600SE	\$6.00

# LITHIUM BATTERIES

## FDK, VARTA CYLINDRICAL...continued from previous page

TYPE	VOLTAGE / CAPACITY	D x H (mm)	IEC	R&D PART	LIST PRICE
CR14250SE	3 Volt / 850mAh	14.5 x 25.5	CR14250	CR1/2AA	\$9.00
CR17335SE	3 Volt / 1800mAh	17.0 x 33.5	CR17338	CR17335SE	\$7.50
CR17450SE	3 Volt / 2500mAh	17.0 x 45.0	CR17450	BR-A	\$12.00
CR23500SE	3 Volt / 5000mAh	23.0 x 50.0	CR23500	CR23500SE	\$18.00
CR2	3 Volt / 850mAh	15.6 x 27.0	CR15H270	CR2	\$9.50
CR-P2	6 Volt / 1400mAh	35 x 20 x 36	2CP4036	CR-P2	\$12.00
CR-V3	3 Volt / 3300mAh	29 x 15 x 52	CP3152	CR-V3	\$20.00
<b>Terminal types: add suffix to Part #</b>		ST= Solder Tabs	P2= 2 Pins 7.5mm (+) and 1 Pin (-)		
<b>Pin Spreads (2 pin side) 7.5mm or 10mm</b>		AX= Axial Leads	P3= 2 Pins 10mm (+) and 1 Pin (-)		
P5= 2 Pins 10mm (-) and 1 Pin (+)		P1= Single Pins (+) and (-)	P4= 2 Pins 7.5mm (-) and 1 Pin (+)		

## FDK COIN CELLS

CR1220	3 Volt / 25mAh	12.5 x 2.0	CR1220	CR1220-S	\$1.80
CR2016	3 Volt / 80mAh	20.0 x 1.6	CR2016	CR2016-S	\$1.80
CR2025	3 Volt / 150mAh	20.0 x 2.5	CR2025	CR2025-S	\$1.80
CR2032	3 Volt / 220mAh	20.0 x 3.2	CR2032	CR2032-S	\$1.80
CR2430	3 Volt / 280mAh	24.5 x 3.0	CR2430	CR2430-S	\$2.85
CR2450	3 Volt / 610mAh	24.5 x 5.0	CR2450	CR2450-S	\$2.85

## TADIRAN

TYPE	VOLTAGE / CAPACITY	D x H (mm)	SIZE	CONTACT	R&D PART	LIST PRICE
TL-5101/S	3.6 Volt / 950mAh	14.5 x 25.2	1/2AA	Pressure	5437	\$9.00
TL-5101/P	3.6 Volt / 950mAh	14.5 x 25.2	1/2AA	Axial Pins	5466	\$9.00
TL-5104/S	3.6 Volt / 2500mAh	14.5 x 50.5	AA	Pressure	5231	\$9.00
TL5104/P	3.6 Volt / 2100mAh	14.5 x 50.5	AA	Axial Pins	5084-A	\$9.00
TL5134/SP	3.6 Volt / 1000mAh	32.9 x 6.5	1/10D	PCB Mount	TL5134	\$10.00
TL-5135/SP	3.6 Volt / 1700mAh	32.9 x 10.2	1/6D	PCB Mount	TL5135	\$15.00
TL-5186	3.6 Volt / 400mAh	18.5 x 6.75	BEL	PCB Mount	TL5186	\$18.00
TL-2150/S	3.6 Volt / 1000mAh	14.5 x 25.2	1/2AA	Pressure	TL2150/S	\$9.00
TL-2150/P	3.6 Volt / 1000mAh	14.5 x 25.2	1/2AA	PCB Mount	TL2150/P	\$9.00
TL5902/S	3.6 Volt / 1200mAh	14.5 x 25.2	1/2AA	Pressure	TL5902/S	\$12.00
TL5902/P	3.6 Volt / 1200mAh	14.5 x 25.2	1/2AA	PCB Mount	TL5902/P	\$12.00
TL5902/T	3.6 Volt / 1200mAh	14.5 x 25.2	1/2AA	Tabs	TL5902/T	\$12.00
TL5955/S	3.6 Volt / 1650mAh	14.5 x 33.5	2/3AA	Pressure	TL5955/S	\$14.00
TL5955/P	3.6 Volt / 1650mAh	14.5 x 33.5	2/3AA	PCB Mount	TL5955/P	\$14.00
TL5955/T	3.6 Volt / 1650mAh	14.5 x 33.5	2/3AA	Tabs	TL5955/T	\$14.00
TL5903/S	3.6 Volt / 2400mAh	14.5 x 50.5	AA	Pressure	TL5903/S	\$15.00
TL5903/P	3.6 Volt / 2400mAh	14.5 x 50.5	AA	PCB Mount	TL5903/P	\$15.00
TL5903/T	3.6 Volt / 2400mAh	14.5 x 50.5	AA	Tabs	TL5903/T	\$15.00
TL-2100/S	3.6 Volt / 2100mAh	14.5 x 50.5	AA	Pressure	TL2100/S	\$9.00
TL-2100/P	3.6 Volt / 2100mAh	14.5 x 50.5	AA	PCB Mount	TL2100/P	\$9.00
TL-2200/S	3.6 Volt / 7200mAh	26.2 x 50.0	C	Pressure	TL2200/S	\$16.00
TL-2300/S	3.6 Volt / 1650mAh	32.9 x 61.5	D	Pressure	TL2300/S	\$29.00
TL-5242/W	3.6 Volt / 2100mAh	15.6 x 61	MBU	Berg Plug	5900	\$15.00
TL-5276/W	3.6 Volt / 1000mAh	16.8 x 28.6	MBU	Berg Plug	TL5276/W	\$16.00
TLM-1550HP/S	3.6 Volt / 500mAh	14.7 x 51.1	AA	Pressure	TLM-1550	\$36.00

## ULTRALIFE 9 VOLT LITHIUM

TYPE	VOLTAGE / CAPACITY	1 to 99	100 to 299	300+	R&D PART
UL9V	9 Volt / 1200mAh	\$5.95	\$5.70	\$5.45	5868
UL9V-FP	9 Volt / 1200mAh	\$5.95	\$5.70	\$5.45	5868-FP



# SEALED LEAD ACID BATTERIES

## R&D BATTERIES VRLA

TYPE	WEIGHT	VOLTAGE / CAPACITY	L x W x H (in)	TERMINAL	R&D PART	LIST PRICE
PS-260	0.89lbs	2 Volts / 6.0Ah	1.97 x 1.34 x 3.94	3/16"	PS-260	\$18.00
A204/1.0K	0.40lbs	4 Volts / 1.0Ah	1.37 x 1.67 x 2.04	Pressure	5346	\$35.00
A204/1.0F	0.40lbs	4 Volts / 1.0Ah	1.37 x 1.67 x 2.04	1/8"	5396	\$35.00
PS-445	1.30lbs	4 Volts / 4.5Ah	1.89 x 2.09 x 3.70	1/4"	5671	\$15.00
A504/3.5S	0.65lbs	4 Volts / 3.5Ah	3.57 x 1.36 x 2.69	3/16"	A504/3.5S	\$25.00
PS-490	2.20lbs	4 Volts / 9.0Ah	4.01 x 1.73 x 3.74	1/4"	PS-490	\$25.00
PS-4100	2.50lbs	4 Volts / 10.0Ah	4.01 x 1.97 x 3.70	3/16"	PS-4100	\$26.95
PS-605	0.20lbs	6 Volts / .50Ah	2.24 x 0.55 x 1.97	Molex Plug	5772	\$15.00
PS-610	0.44lbs	6 Volts / 1.1Ah	2.00 x 1.65 x 2.00	3/16"	5368	\$9.00
PE6V1.2	0.65lbs	6 Volts / 1.2Ah	3.82 x 0.94 x 2.00	3/16"	5746	\$18.00
PS-612	0.66lbs	6 Volts / 1.4Ah	3.82 x 0.94 x 2.00	3/16"	5369	\$10.00
LC-R061R3P	0.65lbs	6 Volts / 1.2Ah	3.82 x 0.94 x 2.00	3/16"	5469	\$14.00
PS-628	1.30lbs	6 Volts / 2.9Ah	2.60 x 1.30 x 3.88	3/16"	5370	\$15.00
PS-630	1.37lbs	6 Volts / 3.5Ah	5.28 x 1.34 x 2.35	3/16"	5371	\$15.00
LC-R063R4P	1.40lbs	6 Volts / 3.4Ah	5.28 x 1.34 x 2.36	3/16"	5675	\$29.00
PS-632	1.37lbs	6 Volts / 3.5Ah	2.60 x 1.30 x 4.69	3/16"	5373	\$22.00
PS-640	1.60lbs	6 Volts / 4.5Ah	2.76 x 1.95 x 4.02	3/16"	5374	\$12.00
NP4-6/.250	1.60lbs	6 Volts / 4.0Ah	2.76 x 1.95 x 4.02	1/4"	5374-F2	\$14.00
LC-R064R5P	1.90lbs	6 Volts / 4.5Ah	2.76 x 1.89 x 4.02	3/16"	5078	\$16.00
PSH-655	2.10lbs	6 Volts / 5.5Ah	2.76 x 1.95 x 4.02	3/16"	5980	\$18.00
PS-650L	1.80lbs	6 Volts / 5.0Ah	2.64 x 2.64 x 3.94	Spring	PS-650L	\$28.00
PS-650LF	1.80lbs	6 Volts / 5.0Ah	2.64 x 2.64 x 3.94	3/16"	PS-650LF	\$28.00
PS-660HF2	2.10lbs	6 Volts / 6.0Ah	2.76 x 1.95 x 4.02	1/4"	5980-F2	\$18.00
PS-665	2.70lbs	6 Volts / 6.5Ah	3.86 x 2.20 x 3.78	3/16"	PS-665	\$16.00
NP7-6	3.00lbs	6 Volts / 7.0Ah	5.95 x 1.34 x 3.72	3/16"	5375	\$18.00
NP7-6/.250	3.00lbs	6 Volts / 7.0Ah	5.95 x 1.34 x 3.72	1/4"	5375-F2	\$16.00
LC-R067R2P	3.00lbs	6 Volts / 7.2Ah	5.95 x 1.34 x 3.72	3/16"	5994	\$24.50
PS-682	3.20lbs	6 Volts / 9.0Ah	3.86 x 2.20 x 4.65	3/16"	5966	\$17.50
PS-6120	4.90lbs	6 Volts / 12.0Ah	4.25 x 2.75 x 5.51	FP-Polarized	5377	\$22.00
PS-6120TH	4.90lbs	6 Volts / 12.0Ah	4.25 x 2.75 x 5.51	H-Connector	PS-6120TH	\$24.00
PS-6120TS	4.90lbs	6 Volts / 12.0Ah	4.25 x 2.75 x 5.51	S-Connector	PS-6120TS	\$24.00
PS-6100	4.30lbs	6 Volts / 12.0Ah	5.95 x 1.97 x 3.70	3/16"	5380	\$18.00
PS-6100F2	4.30lbs	6 Volts / 12.0Ah	5.95 x 1.97 x 3.70	1/4"	5380-F2	\$18.00
LC-R0612P	4.30lbs	6 Volts / 12.0Ah	5.95 x 1.97 x 3.70	3/16"	5614	\$27.00
PS-6200	7.10lbs	6 Volts / 20.0Ah	6.18 x 3.27 x 4.92	Nut & Bolt	5378	\$50.00
PS-6360NB	13.80lbs	6 Volts / 36.0Ah	6.25 x 3.35 x 6.50	Nut&Bolt	5988	\$80.00
PS-6360F2	13.80lbs	6 Volts / 36.0Ah	6.25 x 3.35 x 6.50	1/4"	5988-F2	\$80.00
A208/2.7S	1.80lbs	8 Volts / 2.7Ah	5.24 x 1.42 x 2.54	3/16"	5275	\$54.00
PS-832	1.65lbs	8 Volts / 3.2Ah	5.49 x 1.42 x 2.49	3/16"	PS-832	\$25.00
A508/3.5S	2.20lbs	8 Volts / 3.5Ah	7.01 x 1.34 x 2.48	3/16"	5382	\$49.00
A208/3.8S	2.60lbs	8 Volts / 3.8Ah	3.38 x 2.04 x 3.74	3/16"	5792	\$80.00
PS-1208	0.80lbs	12 Volts / .80Ah	3.78 x 0.98 x 2.42	AMP Plug	5785	\$22.00
NP0.8-12	0.80lbs	12 Volts / .80Ah	3.78 x 0.98 x 2.42	JST Plug	5895	\$22.00
PS-1212	1.20lbs	12 Volts / 1.4Ah	3.82 x 1.65 x 2.00	3/16"	5383	\$18.50
LC-R121R3P	1.20lbs	12 Volts / 1.3Ah	3.89 x 1.87 x 2.00	3/16"	5547	\$27.00
NP1.2-12	1.20lbs	12 Volts / 1.2Ah	3.89 x 1.87 x 2.00	3/16"	5838	\$20.00
NP2-12	1.60lbs	12 Volts / 2.0Ah	5.88 x 0.75 x 3.50	3/16"	5778	\$22.00
PS-1221S	1.60lbs	12 Volts / 2.0Ah	5.88 x 0.75 x 3.50	3/16"	PS-1221S	\$22.00
A512/2S	1.80lbs	12 Volts / 2.0Ah	7.01 x 1.38 x 2.36	3/16"	5992	\$55.00
LC-R122R2P	1.80lbs	12 Volts / 2.2Ah	6.97 x 1.34 x 2.36	3/16"	5991	\$27.00
NP2.3-12	1.80lbs	12 Volts / 2.3Ah	7.01 x 1.34 x 2.36	3/16"	5515	\$20.00
PS-1220	1.80lbs	12 Volts / 2.5Ah	7.01 x 1.34 x 2.36	3/16"	5386	\$20.00
NP2-12C	1.45lbs	12 Volts / 2.3Ah	7.17 x 0.94 x 2.36	Pressure	NP2-12C	\$40.00
EPP100CBK	1.50lbs	12 Volts / 2.3Ah	7.17 x 0.94 x 2.36	Pressure	5389	\$40.00

# SEALED LEAD ACID BATTERIES

## R&D BATTERIES VRLA... continued

TYPE	WEIGHT	VOLTAGE / CAPACITY	L x W x H (in)	TERMINAL	R&D PART	LIST PRICE
PS-1223	1.50lbs	12 Volts / 2.3Ah	7.17 x 0.94 x 2.36	Pressure	PS-1223	\$40.00
EPP101CBK	1.60lbs	12 Volts / 2.3Ah	7.90 x 0.98 x 2.43	Pressure	5387	\$45.00
EPP130CBK	1.50lbs	12 Volts / 2.0Ah	5.65 x 0.94 x 2.55	Pressure	5771	\$42.00
5918	1.60lbs	12 Volts / 2.3Ah	7.17 x 0.94 x 2.36	Pressure	5918	\$40.00
PX12026	2.20lbs	12 Volts / 2.6Ah	7.01 x 1.34 x 2.36	3/16"	5082	\$34.00
SLA1039	2.00lbs	12 Volts / 2.3Ah	4.00 x 1.90 x 2.75	3/16"	6356	\$28.50
PS-1228	3.00lbs	12 Volts / 2.8Ah	5.24 x 1.30 x 3.82	3/16"	5119	\$30.00
PS-1229	2.00lbs	12 Volts / 2.9Ah	7.01 x 1.34 x 2.36	3/16"	5385	\$29.00
PS-1227	2.80lbs	12 Volts / 2.9Ah	3.11 x 2.20 x 4.13	3/16"	5969	\$38.00
PS-1230	2.60lbs	12 Volts / 3.4Ah	5.28 x 2.64 x 2.36	3/16"	5384	\$25.00
LC-R123R4P	2.60lbs	12 Volts / 3.4Ah	5.28 x 2.64 x 2.36	3/16"	5667	\$41.00
A512/3.5S	2.50lbs	12 Volts / 3.5Ah	5.28 x 2.64 x 2.52	3/16"	5972	\$80.00
PS-1238	2.40lbs	12 Volts / 3.8Ah	7.70 x 1.90 x 2.80	3/16"	5993	\$32.00
NP4-12	4.00lbs	12 Volts / 4.0Ah	3.54 x 2.76 x 3.98	3/16"	5417	\$25.00
PS-1250	4.00lbs	12 Volts / 5.0Ah	3.54 x 2.76 x 3.98	3/16"	5388	\$25.00
PS-1250F2	4.00lbs	12 Volts / 5.0Ah	3.54 x 2.76 x 3.98	1/4"	PS-1250F2	\$25.00
PSH-1255FR	4.00lbs	12 Volts / 5.5Ah	3.54 x 2.76 x 3.98	1/4"	5388-F2	\$33.00
NPX-25	4.00lbs	12 Volts / 5.5Ah	3.54 x 2.76 x 3.98	1/4"	NPX-25	\$33.00
A512/6.5S	5.50lbs	12 Volts / 6.5Ah	5.95 x 2.76 x 3.98	3/16"	6022	\$65.00
PS-1270	6.00lbs	12 Volts / 7.0Ah	5.95 x 2.56 x 3.70	3/16"	5390	\$25.00
PS-1270F2	6.00lbs	12 Volts / 7.0Ah	5.95 x 2.56 x 3.70	1/4"	PS-1270F2	\$25.00
NP7-12FR	6.25lbs	12 Volts / 7.0Ah	5.95 x 2.56 x 3.70	3/16"	5390-FR	\$28.00
PS-1280	6.50lbs	12 Volts / 8.0Ah	5.95 x 2.56 x 3.70	3/16"	PS-1280	\$25.00
PS-1280F2	6.50lbs	12 Volts / 8.0Ah	5.95 x 2.56 x 3.70	1/4"	PS-1280F2	\$25.00
PSH-1280FR	6.50lbs	12 Volts / 8.5Ah	5.95 x 2.56 x 3.70	1/4"	5390-F2	\$33.00
PS-1290	6.50lbs	12 Volts / 9.0Ah	5.95 x 2.56 x 3.70	1/4"	1986	\$34.00
PS-1290NB	6.50lbs	12 Volts / 9.0Ah	5.95 x 2.56 x 3.70	Nut & Bolt	PS-1290NB	\$34.00
LC-R127R2P	6.50lbs	12 Volts / 7.2Ah	5.95 x 2.56 x 3.70	3/16"	5780	\$34.00
LC-R127R2P1	6.50lbs	12 Volts / 7.2Ah	5.95 x 2.56 x 3.70	1/4"	LC-R127R2P1	\$34.00
UP-RW1245P1	7.25lbs	12 Volts / 9.0Ah	5.95 x 2.56 x 3.70	1/4"	UP-RW1245P1	\$46.00
NPX-35	7.25lbs	12 Volts / 8.5Ah	5.95 x 2.56 x 3.70	1/4"	NPX-35	\$33.00
BP7-12RT	5.20lbs	12 Volts / 7.0Ah	5.51 x 1.89 x 4.96	Recessed	5045	\$35.00
A512/10S	9.10lbs	12 Volts / 10.0Ah	5.95 x 3.86 x 3.70	3/16"	6018	\$88.00
OE12V11	10.10lbs	12 Volts / 11.0Ah	5.28 x 3.15 x 6.50	Nut & Bolt	OE12V11	\$120.00
PS-12100	9.00lbs	12 Volts / 12.0Ah	5.95 x 3.86 x 3.70	3/16"	PS-12100	\$45.00
PS-12100F2	9.00lbs	12 Volts / 12.0Ah	5.95 x 3.86 x 3.70	1/4"	PS-12100F2	\$45.00
PSH-12100	8.00lbs	12 Volts / 10.5Ah	5.95 x 2.56 x 4.37	1/4"	PSH-12100	\$45.00
PS-12120	9.10lbs	12 Volts / 12.0Ah	5.95 x 3.86 x 3.70	1/4"	5551	\$45.00
PS-12120L	10.00lbs	12 Volts / 12.0Ah	8.38 x 2.75 x 5.50	1/4", 3/16"	5820L	\$37.00
PS-12120S	10.00lbs	12 Volts / 12.0Ah	4.25 x 5.50 x 5.50	1/4", 3/16"	5820S	\$37.00
PS-12140	10.00lbs	12 Volts / 14.0Ah	5.95 x 3.86 x 3.70	1/4"	6225	\$68.00
EVH12150F2	10.00lbs	12 Volts / 15.0Ah	5.95 x 3.86 x 3.70	1/4"	EVH12150F2	\$68.00
PS-12180NB	13.20lbs	12 Volts / 18.0Ah	7.13 x 2.99 x 6.57	Nut & Bolt	5391	\$65.00
PS-12180F2	13.20lbs	12 Volts / 18.0Ah	7.13 x 2.99 x 6.57	1/4"	5391-F2	\$65.00
PS-12180B	13.20lbs	12 Volts / 18.0Ah	7.13 x 2.99 x 6.57	Threaded Insert	PS-12180B	\$65.00
LC-RD1217P	13.50lbs	12 Volts / 17.0Ah	7.13 x 2.99 x 6.58	Nut & Bolt	6081	\$74.75
LC-X1220P	14.00lbs	12 Volts / 20.0Ah	7.20 x 3.10 x 6.60	Nut & Bolt	6040	\$88.00
PSH-12180FR	14.00lbs	12 Volts / 21.0Ah	7.20 x 3.10 x 6.60	Nut & Bolt	PSH-12180	\$59.00
NPX-80B	14.00lbs	12 Volts / 20.0Ah	7.20 x 3.10 x 6.60	Nut & Bolt	NPX-80B	\$70.00
NPX-80BFR	14.00lbs	12 Volts / 20.0Ah	7.20 x 3.10 x 6.60	Nut & Bolt	NPX-80BFR	\$80.00
NPX-80R	14.00lbs	12 Volts / 20.0Ah	7.20 x 3.10 x 6.60	Threaded Insert	NPX-80R	\$70.00
NPX-80RFR	14.00lbs	12 Volts / 20.0Ah	7.20 x 3.10 x 6.60	Threaded Insert	NPX-80RFR	\$70.00
HRL1280W	14.00lbs	12 Volts / 20.0Ah	7.20 x 3.10 x 6.60	Threaded Insert	HRL1280W	\$95.00
PS-12260NB	22.50lbs	12 Volts / 26.0Ah	6.54 x 6.89 x 4.92	Nut & Bolt	5393	\$67.00
PS-12260F	20.60lbs	12 Volts / 26.0Ah	6.54 x 6.89 x 4.92	1/4"	5648	\$67.00

Secondary  
VRLA

# SEALED LEAD ACID BATTERIES

## R&D BATTERIES VRLA...continued

TYPE	WEIGHT	VOLTAGE / CAPACITY	L x W x H (in)	TERMINAL	R&D PART	LIST PRICE
PS-12260B	20.60lbs	12 Volts / 26.0Ah	6.54 x 6.89 x 4.92	Threaded Insert	PS-12260B	\$67.00
LC-X1228P	22.50lbs	12 Volts / 28.0Ah	4.92 x 6.50 x 6.89	Nut & Bolt	5850-B	\$110.00
LC-X1228AP	22.50lbs	12 Volts / 28.0Ah	4.92 x 6.50 x 6.89	Threaded Post	5850	\$110.00
PS-12280	20.70lbs	12 Volts / 28.0Ah	6.50 x 4.92 x 6.97	Nut & Bolt	5983	\$85.00
NPX-100R	22.50lbs	12 Volts / 28.0Ah	6.54 x 4.92 x 6.89	Threaded Insert	NPX-100R	\$128.00
HR12120WFR	25.00lbs	12 Volts / 30.0Ah	6.53 x 4.92 x 6.86	Threaded Insert	HR12120WFR	\$103.00
LC-R1233P	26.00lbs	12 Volts / 33.0Ah	7.70 x 5.12 x 7.09	Nut & Bolt	LC-R1233P	\$132.25
PS-12350NB	25.60lbs	12 Volts / 35.0Ah	7.75 x 5.19 x 6.12	Nut & Bolt	5395	\$85.00
PS-12350B	25.60lbs	12 Volts / 35.0Ah	7.75 x 5.19 x 6.12	Threaded Insert	PS-12350B	\$85.00
PG-12V35FR	25.00lbs	12 Volts / 35.0Ah	7.75 x 5.19 x 6.12	Threaded Insert	6258	\$125.95
CF12V33L	27.50lbs	12 Volts / 36.0Ah	13.40 x 3.35 x 6.95	1/4"	5995L	\$162.00
CF12V33	27.50lbs	12 Volts / 36.0Ah	6.25 x 6.70 x 6.95	1/4"	5995S	\$162.00
PS-12400	29.10lbs	12 Volts / 40.0Ah	7.74 x 6.50 x 6.89	Nut & Bolt	5545	\$125.00
NPX-150B	30.00lbs	12 Volts / 40.0Ah	7.76 x 6.50 x 6.89	Nut & Bolt	NPX-150B	\$180.00
EB50-12	37.00lbs	12 Volts / 50.0Ah	7.76 x 6.50 x 6.73	Threaded Insert	EB50-12	\$175.00
PS-12550	36.00lbs	12 Volts / 55.0Ah	9.04 x 5.45 x 8.98	Nut & Bolt	6274	\$125.00
PG-12V55FR	42.00lbs	12 Volts / 55.0Ah	9.04 x 5.45 x 8.98	Threaded Insert	6269	\$256.50
PS-12750	58.50lbs	12 Volts / 75.0Ah	10.24 x 6.65 x 8.19	Nut & Bolt	5901	\$175.00
PS-121000	69.00lbs	12 Volts / 100.0Ah	12.07 x 6.67 x 8.20	Nut & Bolt	5987	\$215.00

## B&B BATTERY

TYPE	VOLTAGE / CAPACITY	L x W x H (in)	TERMINAL	R&D PART	LIST PRICE
EB12-12	12 Volts / 12.0Ah	5.94 x 3.86 x 3.70	1/4"	EB1212	\$48.00
HR15-12T2	12 Volts / 15.0Ah	5.9 x 3.86 x 3.70	1/4"	HR15-12T2	\$68.00
EB50-12	12 Volts / 50.0Ah	7.76 x 6.50 x 6.73	Threaded Insert	EB50-12	\$175.00
MPL55-12	12 Volts / 55.0Ah	8.98 x 5.47 x 7.87	Nut & Bolt	MPL55-12	\$195.00

## CSB BATTERY

TYPE	VOLTAGE / CAPACITY	L x W x H (in)	TERMINAL	R&D PART	LIST PRICE
HRL634W	6 Volts / 9.0Ah	5.94 x 1.34 x 3.70	1/4"	5376-F2	\$30.00
HR1221WF2	12 Volts / 5.5Ah	3.54 x 2.76 x 4.01	1/4"	5388-F2	\$33.00
EVH12150F2	12 Volts / 15.0Ah	5.94 x 3.86 x 3.80	1/4"	EVH12150F2	\$68.00
HR12120WFR	12 Volts / 30.0Ah	6.54 x 4.93 x 6.90	Threaded Insert	HR12120WFR	\$103.00

## ENERSYS NP SERIES

TYPE	VOLTAGE/CAPACITY	L x W x H (in)	TERMINAL	R&D PART	LIST PRICE
NP1.2-6	6 Volts / 1.2Ah	3.87 x .94 x 2.00	3/16"	NP1.2-6	\$10.00
NP3-6	6 Volts / 3.0Ah	5.28 x 1.34 x 2.35	3/16"	NP3-6	\$15.00
NP4.5-6	6 Volts / 4.5Ah	2.76 x 1.95 x 4.02	3/16"	NP4.5-6	\$12.00
NP5-6	6 Volts / 5.0Ah	2.76 x 1.95 x 4.02	3/16"	NP5-6	\$18.00
NP7-6	6 Volts / 7.0Ah	5.95 x 1.34 x 3.72	3/16"	NP7-6	\$16.00
NP7-6/250	6 Volts / 7.0Ah	5.95 x 1.34 x 3.72	1/4"	5375-F2	\$16.00
NP10-6	6 Volts / 10.0Ah	5.95 x 1.97 x 3.70	3/16"	NP10-6	\$18.00
NPX-50	6 Volts / 13.5Ah	5.95 x 1.97 x 3.70	1/4"	NPX-50	\$18.00
NP0.8-12	12 Volts / 0.8Ah	3.78 x 0.98 x 2.42	JST Plug	5895	\$22.00
NP0.8-12W	12 Volts / 0.8Ah	3.78 x 0.98 x 2.42	AMP Plug	NP0.8-12	\$22.00
NP1.2-12	12 Volts / 1.3Ah	3.82 x 1.89 x 2.15	3/16"	5838	\$20.00
NP2-12	12 Volts / 2.0Ah	5.91 x 0.79 x 3.50	3/16"	5778	\$22.00
NP2-12C	12 Volts / 2.0Ah	7.17 x 0.93 x 2.40	3/16"	NP2-12C	\$40.00
NP2.3-12FR	12 Volts / 2.5Ah	7.01 x 1.34 x 2.52	3/16"	NP2.3-12	\$20.00
NP2.6-12	12 Volts / 2.6Ah	5.28 x 2.64 x 2.52	3/16"	NP2.6-12	\$25.00
NPH3.2-12	12 Volts / 3.2Ah	5.28 x 2.64 x 2.52	3/16"	5679	\$36.75
NP4-12	12 Volts / 4.0Ah	3.54 x 2.76 x 4.17	3/16"	NP5-12	\$25.00
NP5-12	12 Volts / 5.0Ah	3.54 x 2.76 x 4.17	3/16"	NP5-12	\$25.00
NPX-25	12 Volts / 5.0Ah	3.54 x 2.76 x 4.17	1/4"	NPX-25	\$33.00

# SEALED LEAD ACID BATTERIES

## ENERSYS NP SERIES...continued

TYPE	VOLTAGE/CAPACITY	L x W x H (in)	TERMINAL	R&D PART	LIST PRICE
NPX-25FR	12 Volts / 5.0Ah	3.54 x 2.76 x 4.17	1/4"	NPX-25FR	\$36.00
NP7-12	12 Volts / 7.0Ah	5.94 x 2.56 x 3.84	3/16"	NP7-12	\$25.00
NP7-12FR	12 Volts / 7.0Ah	5.94 x 2.56 x 3.84	3/16"	5390-FR	\$25.00
NPX-35	12 Volts / 8.5Ah	5.94 x 2.56 x 3.84	1/4"	NPX-35	\$33.00
NPX-35FR	12 Volts / 8.5Ah	5.94 x 2.56 x 3.84	1/4"	NPX-35FR	\$35.00
NP12-12	12 Volts / 12.0Ah	5.94 x 3.86 x 3.84	1/4"	NP12-12	\$45.00
NP18-12	12 Volts / 17.2Ah	7.13 x 2.99 x 6.57	Nut & Bolt	NP18-12	\$65.00
NPX-80	12 Volts / 20.0Ah	7.13 x 2.99 x 6.57	Nut & Bolt	NPX-80	\$70.00
NPX-80R	12 Volts / 20.0Ah	7.13 x 2.99 x 6.57	Nut & Bolt	NPX-80FR	\$77.00
NP24-12B	12 Volts / 24.0Ah	6.54 x 6.89 x 4.92	Nut & Bolt	NP24-12B	\$67.00
NP24-12T	12 Volts / 24.0Ah	6.54 x 6.89 x 4.92	1/4"	NP24-12T	\$67.00
NPX-100B	12 Volts / 28.0Ah	6.54 x 4.99 x 6.89	Nut & Bolt	NPX-100B	\$128.00
NPX-100R	12 Volts / 28.0Ah	6.54 x 4.99 x 6.89	Receptacle	NPX-100R	\$128.00
NPX-135	12 Volts / 30.0Ah	7.76 x 5.16 x 6.22	Nut & Bolt	NPX-135	\$155.00
NP33-12B	12 Volts / 33.0Ah	7.74 x 5.22 x 6.11	Nut & Bolt	NP33-12	\$95.00
NP33-12R	12 Volts / 33.0Ah	7.74 x 5.22 x 6.11	Receptacle	NP33-12R	\$95.00
NP38-12B	12 Volts / 38.0Ah	7.74 x 6.50 x 6.89	Nut & Bolt	NP38-12B	\$125.00
NP38-12R	12 Volts / 38.0Ah	7.74 x 6.50 x 6.89	Receptacle	NP38-12R	\$125.00
NPX-150B	12 Volts / 40.0Ah	7.76 x 6.50 x 6.89	Nut & Bolt	NPX-150B	\$180.00
NPX-150R	12 Volts / 40.0Ah	7.76 x 6.50 x 6.89	Nut & Bolt	NPX-150R	\$180.00
NP55-12 (22NF)	12 Volts / 56.3Ah	9.86 x 5.48 x 8.15	Nut & Bolt	NP55-12	\$180.00
NP65-12	12 Volts / 65.0Ah	13.78 x 6.54 x 6.85	Nut & Bolt	NP65-12	\$290.00
NP75-12 (GRP 24)	12 Volts / 77.5Ah	11.09 x 6.66 x 8.15	Nut & Bolt	NP75-12	\$232.00
NP90-12	12 Volts / 91.6Ah	13.03 x 6.66 x 8.15	Nut & Bolt	NP90-12	\$255.00
NP100-12 (GRP 27)	12 Volts / 91.6Ah	13.03 x 6.66 x 8.15	Nut & Bolt	NP100-12	\$278.00
NP120-12	12 Volts / 120.0Ah	16.02 x 6.81 x 9.25	Nut & Bolt	NP120-12	\$427.00
NP150-12	12 Volts / 150.0Ah	19.02 x 6.69 x 9.49	Nut & Bolt	NP150-12	\$466.00
NP200-12	12 Volts / 200.0Ah	20.47 x 10.24 x 8.19	Nut & Bolt	NP200-12	\$565.00

## ENERSYS CYCLON

TYPE	VOLTAGE/CAPACITY	L x W x H (in)	CELL SIZE	R&D PART	LIST PRICE
0800-0004	2 Volts / 5.0Ah	1.75 x 2.87	X - Cylindrical	0800-0004	\$9.85
0810-0004	2 Volts / 2.5Ah	1.35 x 2.41	D - Cylindrical	0810-0004	\$7.25
0820-0004	2 Volts / 25.0Ah	2.57 x 6.25	BC - Cylindrical	0820-0004	\$45.00
0840-0004	2 Volts / 12.5Ah	2.04 x 4.85	J - Cylindrical	0840-0004	\$69.00
0850-0004	2 Volts / 8.0Ah	1.75 x 3.94	E - Cylindrical	0850-0004	\$15.00
0860-0004	2 Volts / 4.5Ah	1.75 x 3.78	TD - Cylindrical	0860-0004	\$11.50
0809-0010	4 Volts / 5.0Ah	3.78 x 2.11 x 3.02	X - Monoblock	0809-0010	\$20.00
0809-0012	6 Volts / 5.0Ah	5.47 x 2.11 x 3.02	X - Monoblock	0809-0012	\$33.00
0819-0010	4 Volts / 2.5Ah	3.09 x 1.78 x 2.75	D - Monoblock	0819-0010	\$16.50
0819-0012	6 Volts / 2.5Ah	4.43 x 1.78 x 2.75	D - Monoblock	0819-0012	\$20.00
0859-0010	4 Volts / 8.0Ah	3.77 x 2.11 x 4.00	E - Monoblock	0859-0010	\$30.80
0859-0012	6 Volts / 8.0Ah	5.47 x 2.11 x 4.00	E - Monoblock	0859-0012	\$36.30

## ENERSYS CYCLON ASSEMBLIES

TYPE	VOLTAGE/CAPACITY	L x W x H (in)	DESCRIPTION	LIST PRICE
0800-0008	12 Volts / 5.0Ah	5.44 x 3.70 x 3.14	2 x 3 Double Slot, Styrene Case	\$97.00
0800-0011	6 Volts / 5.0Ah	5.47 x 2.11 x 3.02	1 x 3 Double Slot, ABS Case	\$45.50
0800-0027	8 Volts / 5.0Ah	7.16 x 1.94 x 3.10	1 x 4 Double Slot, ABS Case	\$63.00
0800-0047	12 Volts / 5.0Ah	5.44 x 3.70 x 3.19	2 x 3 Styrene Case, Wire Leads	\$80.00
0800-0072	12 Volts / 5.0Ah	10.66 x 1.96 x 3.15	1 x 6 ABS Case, Wire Leads	\$65.00
0800-0102	6 Volts / 5.0Ah	5.25 x 1.87 x 3.12	1 x 3 Double Slot, Shrink Wrap	\$45.50
0800-0103	6 Volts / 5.0Ah	5.25 x 1.87 x 3.12	1 x 3 Shrink Wrap, Wire Leads	\$48.50
0800-0108	12 Volts / 5.0Ah	10.48 x 1.87 x 3.12	1 x 6 Double Slot, Shrink Wrap	\$80.00
0800-0114	12 Volts / 5.0Ah	5.25 x 3.68 x 3.13	2 x 3 Double Slot, Shrink Wrap	\$80.00
0800-0115	12 Volts / 5.0Ah	5.25 x 3.68 x 3.13	2 x 3 Shrink Wrap, Wire Leads	\$80.00
0810-0008	12 Volts / 2.5Ah	4.23 x 2.88 x 2.72	2 x 3 Double Slot, ABS Case	\$53.00
0810-0011	6 Volts / 2.5Ah	4.23 x 1.55 x 2.75	1 x 3 Double Slot, ABS Case	\$34.50

# SEALED LEAD ACID BATTERIES

## ENERSYS CYCLON ASSEMBLIES...continued

TYPE	VOLTAGE/CAPACITY	L x W x H (in)	DESCRIPTION	LIST PRICE
0810-0075	12 Volts / 2.5Ah	8.22 x 1.53 x 2.69	1 x 6 ABS Case, Wire Leads	\$53.00
0810-0102	6 Volts / 2.5Ah	4.05 x 1.48 x 2.66	1 x 3 Double Slot, Shrink Wrap	\$34.50
0810-0104	8 Volts / 2.5Ah	6.96 x 1.48 x 2.97	1 x 4 Double Slot, Shrink Wrap	\$44.00
0810-0108	12 Volts / 2.5Ah	8.08 x 1.48 x 2.66	1 x 6 Shrink, Double Slot	\$53.00
0810-0109	12 Volts / 2.5Ah	8.08 x 1.48 x 2.66	1 x 6 Shrink, Wire Leads	\$53.00
0810-0114	12 Volts / 2.5Ah	4.05 x 2.82 x 2.67	2 x 3 Double Slot, Shrink Wrap	\$53.00
0810-0115	12 Volts / 2.5Ah	4.05 x 2.82 x 2.67	2 x 3 Shrink Wrap, Wire Leads	\$53.00
0820-0014	6 Volts / 25.0Ah	8.05 x 2.85 x 7.16	1 x 3 Copper Straps	\$182.00
0840-0114	12 Volts / 12.5Ah	6.11 x 4.18 x 5.41	2 x 3 With Shrink	\$132.00
0840-0115	12 Volts / 12.5Ah	6.11 x 4.18 x 5.41	2 x 3 Shrink With Leads	\$132.00
0809-0020	12 Volts / 5.0Ah	10.94 x 2.11 x 3.02	2 x 3 Hawker Monoblock	\$44.00
0819-0014	8 Volts / 2.5Ah	6.12 x 1.78 x 2.75	1 x 4 Hawker Monoblock	\$33.00
0819-0019	8 Volts / 2.5Ah	3.09 x 3.50 x 2.75	2 x 2 Hawker Monoblock	\$33.00
0819-0020	12 Volts / 2.5Ah	5.48 x 4.18 x 3.04	2 x 3 Hawker Monoblock	\$40.00
0859-0014	8 Volts / 8.0Ah	7.54 x 2.11 x 4.00	1 x 4 Hawker Monoblock	\$63.00
0859-0016	12 Volts / 8.0Ah	10.88 x 2.11 x 4.00	1 x 6 Hawker Monoblock	\$74.00
0859-0019	8 Volts / 8.0Ah	3.77 x 4.16 x 4.00	2 x 2 Hawker Monoblock	\$63.00
0859-0020	12 Volts / 8.0Ah	5.48 x 4.18 x 4.02	2 x 3 Hawker Monoblock	\$74.00

## ENERSYS DATASAFE HX

TYPE	VOLTAGE/CAPACITY	L x W x H (in)	TERMINAL	R&D PART	LIST PRICE
6HX50FR	6 Volt / 13.0Ah	5.90 x 2.00 x 3.90	3/16" or 1/4"	6HX50FR	\$88.00
12HX80FR	12 Volt / 20.0Ah	7.10 x 3.00 x 6.60	Threaded Insert	12HX80FR	\$137.00
12HX100FR	12 Volt / 28.0Ah	6.50 x 4.90 x 6.90	Threaded Insert	12HX100FR	\$225.00
12HX205FR	12 Volt / 44.0Ah	8.90 x 5.50 x 8.10	Threaded Insert	12HX205FR	\$255.00
12HX300FR	12 Volt / 72.0Ah	10.20 x 6.90 x 8.20	Threaded Insert	12HX300FR	\$318.00
12HX330FR	12 Volt / 83.0Ah	11.80 x 6.80 x 8.40	Threaded Insert	12HX330FR	\$360.00
12HX400FR	12 Volt / 95.0Ah	13.30 x 6.80 x 8.30	Threaded Insert	12HX400FR	\$409.00
12HX505FR	12 Volt / 123.0Ah	13.30 x 6.80 x 10.70	Threaded Insert	12HX505FR	\$550.00

## ENERSYS PURE LEAD

TYPE	VOLTAGE/CAPACITY	L x W x H (in)	TERMINAL	R&D PART	LIST PRICE
G13EP - 0770-2007	12 Volts / 13.0Ah	6.91 x 3.28 x 5.11	Recessed	5722	\$126.50
G16EP - 0769-2007	12 Volts / 16.0Ah	7.15 x 3.36 x 5.16	Recessed	G16EP	\$140.00
G26EP - 0765-2001	12 Volts / 26.0Ah	6.56 x 6.92 x 4.95	Recessed	5970	\$194.00
G42EP - 0766-2001	12 Volts / 42.0Ah	7.77 x 6.52 x 6.71	Recessed	G42EP	\$268.00
G70EP - 0771-2001	12 Volts / 70.0Ah	13.02 x 6.62 x 6.93	Recessed	G70EP	\$378.00
XE13	12 Volts / 13.0Ah	6.89 x 3.27 x 5.08	Recessed	XE13	\$164.00
XE16	12 Volts / 16.0Ah	7.12 x 2.99 x 6.57	Recessed	XE16	\$171.00
XE30	12 Volts / 30.0Ah	6.53 x 6.89 x 4.92	Recessed	XE30	\$254.00
XE40	12 Volts / 40.0Ah	7.74 x 6.50 x 6.69	Recessed	XE40	\$336.00
XE60	12 Volts / 60.0Ah	10.85 x 6.76 x 7.12	Recessed	XE60	\$398.00
XE70	12 Volts / 70.0Ah	12.94 x 6.54 x 6.85	Recessed	XE70	\$475.00
XE95	12 Volts / 95.0Ah	12.99 x 6.79 x 8.62	Recessed	XE95	\$630.00

## ENERSYS SBS SERIES

TYPE	VOLTAGE/CAPACITY	L x W x H (in)	TERMINAL	R&D PART	LIST PRICE
SBS30	12 Volts / 26.0Ah	9.8 x 3.8 x 6.1	Threaded Post	SBS 30	\$242.00
SBS60	12 Volts / 51.0Ah	8.7 x 4.8 x 10.2	Threaded Post	SBS 60	\$363.00

# SEALED LEAD ACID BATTERIES

## PANASONIC

TYPE	VOLTAGE/CAPACITY	L x W x H (in)	TERMINAL	R&D PART	LIST PRICE
LC-R061R3P	6 Volts / 1.3Ah	3.82 x 0.95 x 1.97	3/16"	5469	\$14.00
LC-R063R4P	6 Volts / 3.4Ah	5.28 x 1.34 x 2.36	3/16"	5675	\$29.00
LC-R064R5P	6 Volts / 4.5Ah	2.76 x 1.89 x 4.02	3/16"	5078	\$16.00
LC-R067R2P	6 Volts / 7.2Ah	5.95 x 1.34 x 3.70	3/16"	5994	\$24.50
LC-R0612P	6 Volts / 12.0Ah	5.95 x 1.97 x 3.70	3/16"	5614	\$27.00
LC-R121R3P	12 Volts / 1.3Ah	3.82 x 1.87 x 1.97	3/16"	5547	\$27.00
LC-R122R2P	12 Volts / 2.2Ah	6.97 x 1.34 x 2.36	3/16"	5991	\$27.00
LC-SA122R3EU	12 Volts / 2.3Ah	7.17 x 0.94 x 2.36	Pressure	5389	\$40.00
LC-S122BU	12 Volts / 2.3Ah	7.90 x 0.98 x 2.43	Pressure	5387	\$45.00
LC-SD122BU	12 Volts / 2.0Ah	5.65 x 0.94 x 2.55	Pressure	5771	\$42.00
LC-TA122PU	12 Volts / 2.0Ah	7.17 x 0.94 x 2.36	Pressure	5918	\$40.00
LCR-6V2.4P	6 Volts / 2.4Ah	2.60 x 1.30 x 3.88	3/16"	5370	\$15.00
LCS-2912P	12 Volts / 2.9Ah	3.11 x 2.20 x 4.13	3/16"	5969	\$38.00
LCR-6V3.2P	6 Volts / 3.2Ah	2.60 x 1.30 x 4.69	3/16"	5373	\$22.00
LC-R123R4P	12 Volts / 3.4Ah	5.28 x 2.64 x 2.36	3/16"	5667	\$41.00
UP-RW1220P1	12 Volts / 4.0Ah	5.51 x 1.52 x 3.70	1/4"	UP-RW1220P1	\$39.00
LC-R127R2P	12 Volts / 7.2Ah	5.95 x 2.54 x 3.70	3/16"	5780	\$34.00
LC-R127R2P1	12 Volts / 7.2Ah	5.95 x 2.54 x 3.70	1/4"	LC-R127R2P1	\$33.93
UP-VW1245P1	12 Volts / 9.0Ah	5.95 x 2.54 x 3.70	1/4"	UP-VW1245P1	\$39.00
LC-RA1212P1	12 Volts / 12.0Ah	5.95 x 3.86 x 3.70	1/4"	LC-RA1212P1	\$51.75
LC-RD1217P	12 Volts / 17.0Ah	7.13 x 2.99 x 6.58	Nut & Bolt	6081	\$74.75
LC-X1220P	12 Volts / 20.0Ah	7.20 x 3.10 x 6.60	Nut & Bolt	6040	\$88.00
LC-X1228AP	12 Volts / 28.0Ah	6.50 x 4.92 x 6.89	Threaded Post	5850	\$110.00
LC-X1228P	12 Volts / 28.0Ah	6.50 x 4.92 x 7.07	Nut & Bolt	5850-B	\$110.00
LC-R1233P	12 Volts / 33.0Ah	7.70 x 5.12 x 7.09	Nut & Bolt	LC-R1233P	\$132.25

## POWERSONIC PS SERIES

TYPE	VOLTAGE/CAPACITY	L x W x H (in)	TERMINAL	R&D PART	LIST PRICE
PS-260	2 Volts / 6.0Ah	1.97 x 1.34 x 3.94	3/16"	PS-260	\$18.00
PS-445	4 Volts / 4.5Ah	1.89 x 2.09 x 3.70	1/4"	5671	\$15.00
PS-490	4 Volts / 9.0Ah	4.01 x 1.73 x 3.74	1/4"	PS-490	\$25.00
PS-4100	4 Volts / 10.0Ah	4.01 x 1.97 x 3.70	3/16"	PS-4100	\$26.95
PS-605	6 Volts / .05Ah	2.24 x 0.55 x 1.97	Molex	5772	\$15.00
PS-610	6 Volts / 1.1Ah	2.00 x 1.65 x 2.00	3/16"	5368	\$9.00
PS-612	6 Volts / 1.4Ah	3.82 x 0.94 x 2.00	3/16"	5369	\$10.00
PS-621	6 Volts / 2.0Ah	1.69 x 1.46 x 2.99	1/8"	PS-621	\$12.00
PS-628	6 Volts / 2.8Ah	2.60 x 1.30 x 3.88	3/16"	5370	\$15.00
PS-630	6 Volts / 3.5Ah	5.28 x 1.34 x 2.35	3/16"	5371	\$15.00
PS-632	6 Volts / 3.2Ah	2.60 x 1.30 x 4.69	3/16"	5373	\$22.00
PS-640F	6 Volts / 4.5Ah	2.76 x 1.95 x 4.02	3/16"	PS-640	\$12.00
PS-650L	6 Volts / 5.0Ah	2.64 x 2.64 x 3.94	Spring	PS-650L	\$28.00
PS-650LF	6 Volts / 5.0Ah	2.64 x 2.64 x 3.94	3/16"	PS-650LF	\$28.00
PS-660HF2	6 Volts / 6.0Ah	2.76 x 1.95 x 4.02	1/4"	5980-F2	\$18.00
PS-665	6 Volts / 6.5Ah	3.86 x 2.20 x 3.78	FP-Polarized	PS-665	\$16.00
PS-670	6 Volts / 7.0Ah	5.95 x 1.34 x 3.72	3/16"	PS-670	\$16.00
PS-682	6 Volts / 9.0Ah	3.86 x 2.20 x 4.65	3/16"	5966	\$17.50
PS-6100	6 Volts / 10.0Ah	5.95 x 1.97 x 3.70	3/16"	5380	\$18.00
PS-6100F2	6 Volts / 10.0Ah	5.95 x 1.97 x 3.70	1/4"	5380-F2	\$18.00
PS-6120	6 Volts / 12.0Ah	4.25 x 2.75 x 5.51	FP-Polarized	5377	\$22.00
PS-6120 TH	6 Volts / 12.0Ah	4.25 x 2.75 x 5.51	H-Connector	PS-6120TH	\$24.00
PS-6120 TS	6 Volts / 12.0Ah	4.25 x 2.75 x 5.51	S-Connector	PS-6120TS	\$24.00
PS-6200	6 Volts / 20.0Ah	6.18 x 3.27 x 4.92	Nut & Bolt	5378	\$50.00
PS-6360NB	6 Volts / 36.0Ah	6.25 x 3.35 x 6.50	Nut & Bolt	5988	\$80.00
PS-6360F2	6 Volts / 36.0Ah	6.25 x 3.35 x 6.50	1/4"	5988-F2	\$80.00

# SEALED LEAD ACID BATTERIES

## POWERSONIC PS SERIES...continued

TYPE	VOLTAGE/CAPACITY	L x W x H (in)	DESCRIPTION		LIST PRICE
PS-832	8 Volts / 3.2Ah	5.49 x 1.42 x 2.49	3/16"	PS-832	\$25.00
PS-1208	12 Volts / .80Ah	3.78 x 0.98 x 2.42	AMP Plug	5785	\$22.00
PS-1212	12 Volts / 1.3Ah	3.62 x 1.65 x 2.00	3/16"	5383	\$18.50
PS-1220	12 Volts / 2.5Ah	7.01 x 1.34 x 2.36	3/16"	5386	\$20.00
PS-1221	12 Volts / 2.0Ah	5.65 x 0.94 x 2.55	Pressure	PS-1221	\$45.00
PS-1221S	12 Volts / 2.0Ah	5.88 x 0.75 x 3.50	3/16"	PS-1221S	\$22.00
PS-1223	12 Volts / 2.3Ah	7.17 x 0.94 x 2.36	Pressure	PS-1223	\$40.00
PS-1227	12 Volts / 2.9Ah	3.11 x 2.20 x 4.13	3/16"	5969	\$38.00
PS-1228	12 Volts / 2.8Ah	5.24 x 1.30 x 3.82	3/16"	5119	\$30.00
PS-1229	12 Volts / 2.9Ah	7.01 x 1.34 x 2.36	3/16"	5385	\$29.00
PS-1230	12 Volts / 3.4Ah	5.28 x 2.64 x 2.36	3/16"	5384	\$25.00
PS-1238	12 Volts / 3.8Ah	7.70 x 1.90 x 2.80	3/16"	5993	\$32.00
PS-1250	12 Volts / 5.0Ah	3.54 x 2.76 x 3.98	3/16"	5388	\$25.00
PS-1250F2	12 Volts / 5.0Ah	3.54 x 2.76 x 3.98	1/4"	5388-F2	\$33.00
PS-1251FP	12 Volts / 5.4Ah	5.50 x 1.90 x 4.06	Recessed	1984	\$36.00
PS-1270	12 Volts / 7.0Ah	5.95 x 2.56 x 3.70	3/16"	5390	\$25.00
PS-1270F2	12 Volts / 7.0Ah	5.95 x 2.56 x 3.70	1/4"	PS-1270F2	\$25.00
PS-1280	12 Volts / 8.0Ah	5.95 x 2.56 x 3.72	3/16"	PS-1280	\$25.00
PS-1280F2	12 Volts / 8.0Ah	5.95 x 2.56 x 3.72	1/4"	PS-1280F2	\$25.00
PS-1290	12 Volts / 9.0Ah	5.95 x 2.56 x 3.70	1/4"	PS-1290	\$34.00
PS-1290NB	12 Volts / 9.0Ah	5.95 x 2.56 x 3.70	Nut & Bolt	PS-1290NB	\$34.00
PS-1282S	12 Volts / 9.0Ah	3.86 x 4.40 x 4.65	3/16"	5796S	\$40.00
PS-1282L	12 Volts / 9.0Ah	7.72 x 2.20 x 4.65	3/16"	5796L	\$40.00
PS-12100	12 Volts / 12.0Ah	5.95 x 4.00 x 3.70	3/16"	PS-12100	\$45.00
PS-12120L	12 Volts / 12.0Ah	8.45 x 2.75 x 5.75	1/4", 3/16"	5820L	\$37.00
PS-12120S	12 Volts / 12.0Ah	4.25 x 4.25 x 5.75	1/4", 3/16"	5820S	\$29.00
PS-12120	12 Volts / 12.0Ah	5.95 x 3.86 x 3.70	1/4"	PS-12120	\$45.00
PS-12120NB	12 Volts / 12.0Ah	5.95 x 3.86 x 3.70	Nut & Bolt	PS-12120NB	\$45.00
PS-12140	12 Volts / 14.0Ah	5.95 x 3.86 x 3.70	1/4"	PS-12140	\$59.50
PS-12180NB	12 Volts / 18.0Ah	7.13 x 2.99 x 6.57	Nut & Bolt	PS-12180	\$65.00
PS-12180F	12 Volts / 18.0Ah	7.13 x 2.99 x 6.57	1/4" Faston	5391-F2	\$65.00
PS-12180B	12 Volts / 18.0Ah	7.13 x 2.99 x 6.57	Threaded Insert	PS-12180B	\$65.00
PS-12200NB	12 Volts / 20.0Ah	7.13 x 3.00 x 6.57	Nut & Bolt	PS-12200NB	\$59.00
PS-12260NB	12 Volts / 26.0Ah	6.56 x 6.97 x 4.92	Nut & Bolt	PS-12260NB	\$67.00
PS-12260F	12 Volts / 26.0Ah	6.56 x 6.97 x 4.92	1/4" Faston	PS-12260F2	\$67.00
PS-12280	12 Volts / 28.0Ah	6.50 x 4.92 x 6.97	Nut & Bolt	5983	\$85.00
PS-12330	12 Volts / 35.0Ah	7.80 x 5.20 x 6.22	Nut & Bolt	PS-12350NB	\$85.00
PS-12350NB	12 Volts / 35.0Ah	7.80 x 5.20 x 6.22	Nut & Bolt	5395	\$85.00
PS-12350B	12 Volts / 35.0Ah	7.80 x 5.20 x 6.22	Threaded Insert	PS-12350B	\$85.00
PS-12400	12 Volts / 40.0Ah	7.76 x 6.50 x 6.69	Nut & Bolt	5545	\$125.00
PS-12550	12 Volts / 55.0Ah	9.04 x 5.45 x 8.15	Nut & Bolt	6274	\$125.00
PS-12750	12 Volts / 75.0Ah	10.25 x 6.60 x 8.15	Nut & Bolt	PS-12750	\$175.00
PS-121000	12 Volts / 100.0Ah	12.0 x 6.60 x 8.15	Nut & Bolt	5987	\$215.00
PS-121100	12 Volts / 110.0Ah	13.0 x 6.73 x 8.35	Threaded Insert	PS-121100	\$325.00
PS-121400FR	12 Volts / 140.0Ah	13.5 x 6.73 x 10.80	Threaded Insert	PS-121400	\$525.00

# SEALED LEAD ACID BATTERIES

## POWERSONIC PSH SERIES

### HIGH RATE DISCHARGE SEALED LEAD ACID BATTERIES

TYPE	VOLTAGE/CAPACITY	L x W x H (in)	TERMINAL	R&D PART	LIST PRICE
PSH-655FR	6 Volts / 5.5Ah	2.75 x 1.95 x 4.02	3/16"	5980	\$18.00
PSH-1255FR	12 Volts / 6.0Ah	3.54 x 2.76 x 3.98	1/4"	PSH-1255	\$33.00
PSH-1280FR	12 Volts / 8.0Ah	5.95 x 2.56 x 3.70	1/4"	PSH-1280	\$33.00
PSH-12100FR	12 Volts / 10.5Ah	5.94 x 2.56 x 4.37	1/4"	PSH-12100	\$35.00
PSH-12180FR	12 Volts / 21.0Ah	7.13 x 2.99 x 6.57	Nut & Bolt	PSH-12180	\$59.00

## POWERSONIC PG SERIES

### POWER GUARD LONG LIFE SEALED LEAD ACID BATTERIES

TYPE	VOLTAGE/CAPACITY	L x W x H (in)	TERMINAL	R&D PART	LIST PRICE
PG-6V210FR	6 Volts / 210.0Ah	12.70 x 7.00 x 8.98	Threaded Insert	PG-6V210	\$446.50
PG-12V28FR	12 Volts / 28.0Ah	6.96 x 6.96 x 4.92	Threaded Insert	PG-12V28	\$125.95
PG-12V35FR	12 Volts / 35.0Ah	7.80 x 5.20 x 6.22	Threaded Insert	6258	\$137.75
PG-12V42FR	12 Volts / 42.0Ah	7.76 x 6.50 x 6.69	Threaded Insert	PG-12V42	\$175.00
PG-12V55FR	12 Volts / 55.0Ah	8.98 x 5.39 x 8.27	Threaded Insert	6269	\$256.50
PG-12V65FR	12 Volts / 65.0Ah	13.70 x 6.57 x 7.00	Threaded Insert	PG-12V65	\$292.95
PG-12V75FR	12 Volts / 75.0Ah	13.70 x 6.57 x 7.00	Threaded Insert	PG-12V75	\$304.50
PG-12V75TFR	12 Volts / 75.0Ah	10.24 x 6.61 x 8.27	Threaded Insert	PG-12V75T	\$342.25
PG-12V92FR	12 Volts / 92.0Ah	12.05 x 6.61 x 8.27	Threaded Insert	PG-12V92	\$388.50
PG-12V103FR	12 Volts / 103.0Ah	13.00 x 6.80 x 8.35	Threaded Insert	PG-12V103	\$418.95
PG-12V120FR	12 Volts / 124.0Ah	16.14 x 6.97 x 8.86	Threaded Insert	PG-12V120	\$452.25
PG-12V140FR	12 Volts / 144.0Ah	13.50 x 6.73 x 11.02	Threaded Insert	PG-12V140	\$595.25
PG-12V150FR	12 Volts / 153.0Ah	19.10 x 6.70 x 9.53	Threaded Insert	PG-12V150	\$623.25
PG-12V200FR	12 Volts / 210.0Ah	20.55 x 9.45 x 8.82	Threaded Insert	PG-12V200	\$745.95

## POWERSONIC SUPER SPORT SERIES

### FOR MOTORCYCLE, ATV, PERSONAL WATERCRAFT, SNOWMOBILE, ETC.

TYPE	VOLTAGE/CAPACITY	L x W x H (in)	R&D PART
High Performance	12 Volts / 4.0Ah	4 3/4" x 2 3/4" x 3 5/8"	CB4L-B
High Performance	12 Volts / 11.0Ah	5 5/16" x 3 9/16" x 5 3/4"	CB10L-A2
High Performance	12 Volts / 12.0Ah	5 5/16" x 3 3/16" x 6 5/16"	CB12A-A+
High Performance	12 Volts / 12.0Ah	5 5/16" x 3 3/16" x 5 5/16"	CB12AL-A
High Performance	12 Volts / 14.0Ah	5 5/16" x 3 1/2" x 6 9/16"	CB14-A2
High Performance	12 Volts / 14.0Ah	5 5/16" x 3 1/2" x 6 15/16"	CB14A-A
High Performance	12 Volts / 14.0Ah	5 5/16" x 3 1/2" x 6 15/16"	CB14A-A2
High Performance	12 Volts / 19.0Ah	6 7/8" x 4" x 6 1/8"	CB16-B
High Performance	12 Volts / 16.0Ah	8 1/8" x 2 13/16" x 6 7/16"	CB16AL-A2
High Performance	12 Volts / 19.0Ah	6 7/8" x 4" x 6 7/8"	CB16CL-B
High Performance	12 Volts / 19.0Ah	6 7/8" x 4" x 6 1/8"	CB16L-B+
High Performance	12 Volts / 16.0Ah	6" x 3 5/8" x 7 1/16"	HCB16A-AB
High Performance	12 Volts / 18.0Ah	7 1/8" x 3 9/16" x 6 3/8"	CB18L-A
High Performance	12 Volts / 20.0Ah	8 1/8" x 3 9/16" x 6 3/8"	C50-N18L-A3
Sealed Maintenance Free	12 Volts / 3.0Ah	4 1/2" x 2 13/16" x 3 3/8"	PTX4L-BS
Sealed Maintenance Free	12 Volts / 4.0Ah	4 1/2" x 2 13/16" x 4 3/16"	PTX5L-BS
Sealed Maintenance Free	12 Volts / 8.0Ah	6" x 3 7/16" x 4 3/16"	PTX9-BS
Sealed Maintenance Free	12 Volts / 10.0Ah	6" x 3 7/16" x 5 1/8"	PTX12-BS
Sealed Maintenance Free	12 Volts / 12.0Ah	6" x 3 7/16" x 5 3/4"	PTX14-BS
Sealed Maintenance Free	12 Volts / 18.0Ah	6 7/8" x 3 7/16" x 6 1/8"	PTX20L-BS
Conventional 12 Volt	12 Volts / 7.0Ah	5 5/16" x 3" x 5 1/4"	12N7-4A
Conventional 12 Volt	12 Volts / 9.0Ah	5 5/16" x 3" x 5 1/2"	12N9-4B-1
Conventional 12 Volt	12 Volts / 12.0Ah	5 5/16" x 3 3/16" x 6 15/16"	12N12A-4A-1
Conventional 12 Volt	12 Volts / 14.0Ah	5 5/16" x 3 1/2" x 6 9/16"	12N14-3A

Visit [www.power-sonic.com](http://www.power-sonic.com) for terminal descriptions and use the battery finder tool to locate your correct replacement.

**\*\*Call for pricing.\*\***



# SEALED LEAD ACID BATTERIES

## SONNENSCHN

TYPE	VOLTAGE/CAPACITY	L x W x H (in)	TERMINAL	R&D PART	LIST PRICE
A204/1.0K	4 Volts / 1.0Ah	1.37 x 1.67 x 2.04	Pressure	5346	\$35.00
A204/1.0F	4 Volts / 1.0Ah	1.37 x 1.67 x 2.04	1/8"	5396	\$35.00
A504/3.5S	4 Volts / 3.5Ah	3.57 x 1.36 x 2.69	3/16"	A504/3.5S	\$25.00
A208/2.7S	8 Volts / 2.7Ah	5.24 x 1.42 x 2.54	3/16"	5275	\$54.00
A508/3.5S	8 Volts / 3.5Ah	7.01 x 1.34 x 2.48	3/16"	5382	\$49.00
A208/3.8S	8 Volts / 3.8 Ah	3.38 x 2.04 x 3.74	3/16"	5792	\$80.00
A512/2S	12 Volts / 2.0Ah	7.01 x 1.38 x 2.36	3/16"	5992	\$55.00
A512/3.5S	12 Volts / 3.5Ah	5.28 x 2.64 x 2.52	3/16"	5972	\$80.00
A512/6.5S	12 Volts / 6.5Ah	5.95 x 2.56 x 3.70	3/16"	6022	\$65.00
A512/30G6	12 Volts / 30.0Ah	7.80 x 5.20 x 6.22	Nut & Bolt	6286	\$345.00
A512/115A	12 Volts / 115Ah	11.26 x 10.59 x 9.05	Nut & Bolt	A512/115A	\$625.00
A512/10S	12 Volts / 10.0Ah	5.95 x 3.86 x 3.70	3/16"	6018	\$88.00

## YUASA

TYPE	VOLTAGE/CAPACITY	L x W x H (in)	TERMINAL	R&D PART	LIST PRICE
NP1.2-6	6 Volts / 1.2Ah	3.87 x .94 x 2.00	3/16"	NP1.2-6	\$10.00
NP3-6	6 Volts / 3.0Ah	5.28 x 1.34 x 2.35	3/16"	NP3-6	\$15.00
NP4-6/250	6 Volts / 4.0Ah	2.76 x 1.95 x 4.02	1/4"	5374-F2	\$14.00
NP4-6	6 Volts / 4.0Ah	2.76 x 1.95 x 4.02	3/16"	NP4-6	\$12.00
NP4.5-6	6 Volts / 4.5Ah	2.76 x 1.95 x 4.02	3/16"	NP4.5-6	\$12.00
NP5-6	6 Volts / 5.0Ah	2.76 x 1.95 x 4.02	3/16"	NP5-6	\$18.00
NP7-6	6 Volts / 7.0Ah	5.95 x 1.34 x 3.72	3/16"	NP7-6	\$16.00
NP7-6FR	6 Volts / 7.0Ah	5.95 x 1.34 x 3.72	3/16"	NP7-6FR	\$16.00
NP7-6/250	6 Volts / 7.0Ah	5.95 x 1.34 x 3.72	1/4"	5375-F2	\$16.00
NP10-6	6 Volts / 10.0Ah	5.95 x 1.97 x 3.70	3/16"	NP10-6	\$18.00
NPX-50	6 Volts / 13.5Ah	5.95 x 1.97 x 3.70	1/4"	NPX-50	\$18.00
NPX-50FR	6 Volts / 13.5Ah	5.95 x 1.97 x 3.70	1/4"	NPX-50FR	\$18.00
NP0.8-12	12 Volts / 0.8Ah	3.78 x 0.98 x 2.42	JST Plug	5895	\$22.00
NP1.2-12	12 Volts / 1.3Ah	3.82 x 1.89 x 2.15	3/16"	5838	\$20.00
NP2-12	12 Volts / 2.0Ah	5.91 x 0.79 x 3.50	3/16"	5778	\$22.00
NP2.3-12FR	12 Volts / 2.5Ah	7.01 x 1.34 x 2.52	3/16"	NP2.3-12FR	\$20.00
NP2.6-12FR	12 Volts / 2.6Ah	5.28 x 2.64 x 2.52	3/16"	NP2.6-12	\$36.75
NPH3.2-12	12 Volts / 3.2Ah	5.28 x 2.64 x 2.52	3/16"	5679	\$36.75
NP4-12	12 Volts / 4.0Ah	3.54 x 2.76 x 4.17	3/16"	5417	\$25.00
NP4-12FR	12 Volts / 4.0Ah	3.54 x 2.76 x 4.17	3/16"	NP4-12FR	\$25.00
NP5-12	12 Volts / 5.0Ah	3.54 x 2.76 x 4.17	3/16"	NP5-12	\$25.00
NP5-12FR	12 Volts / 5.0Ah	3.54 x 2.76 x 4.17	3/16"	NP5-12FR	\$25.00
NPX-25	12 Volts / 5.0Ah	3.54 x 2.76 x 4.17	1/4"	NPX-25	\$33.00
NPX-25FR	12 Volts / 5.0Ah	3.54 x 2.76 x 4.17	1/4"	NPX-25FR	\$33.00
NP7-12	12 Volts / 7.0Ah	5.94 x 2.56 x 3.84	3/16"	NP7-12	\$25.00
NP7-12FR	12 Volts / 7.0Ah	5.94 x 2.56 x 3.84	3/16"	5390-FR	\$25.00
NPX-35	12 Volts / 8.5Ah	5.94 x 2.56 x 3.84	1/4"	NPX-35	\$33.00
NPX-35FR	12 Volts / 8.5Ah	5.94 x 2.56 x 3.84	1/4"	NPX-35FR	\$33.00
NP12-12	12 Volts / 12.0Ah	5.94 x 3.86 x 3.84	1/4"	NP12-12	\$45.00
NP12-12FR	12 Volts / 12.0Ah	5.94 x 3.86 x 3.84	1/4"	NP12-12FR	\$45.00
NP18-12B	12 Volts / 17.2Ah	7.13 x 2.99 x 6.57	Nut & Bolt	NP18-12	\$65.00
NP18-12BFR	12 Volts / 17.2Ah	7.13 x 2.99 x 6.57	Nut & Bolt	NP18-12FR	\$65.00
NPX-80	12 Volts / 18.5Ah	7.13 x 2.99 x 6.57	Nut & Bolt	NPX-80	\$70.00
NPX-80FR	12 Volts / 18.5Ah	7.13 x 2.99 x 6.57	Nut & Bolt	NPX-80FR	\$70.00
NP24-12B	12 Volts / 24.0Ah	6.54 x 6.89 x 4.92	Nut & Bolt	NP24-12B	\$67.00
NP24-12BFR	12 Volts / 24.0Ah	6.54 x 6.89 x 4.92	Nut & Bolt	NP24-12BFR	\$67.00
NP24-12T	12 Volts / 24.0Ah	6.54 x 6.89 x 4.92	1/4"	NP24-12T	\$67.00
NPX-80B	12 Volts / 20.0Ah	7.13 x 2.99 x 6.57	Nut & Bolt	NPX-80B	\$70.00
NPX-80BFR	12 Volts / 20.0Ah	7.13 x 2.99 x 6.57	Nut & Bolt	NPX-80BFR	\$80.00

# SEALED LEAD ACID BATTERIES

## YUASA...continued

TYPE	VOLTAGE/CAPACITY	L x W x H (in)	TERMINAL	R&D PART	LIST PRICE
NPX-80R	12 Volts / 20.0Ah	7.13 x 2.99 x 6.57	Receptacle	NPX-80R	\$70.00
NPX-80RFR	12 Volts / 20.0Ah	7.13 x 2.99 x 6.57	Receptacle	NPX-80RFR	\$70.00
NPX-100B	12 Volts / 28.0Ah	6.54 x 4.99 x 6.89	Nut & Bolt	NPX-100B	\$128.00
NPX-100RFR	12 Volts / 28.0Ah	6.54 x 4.99 x 6.89	Receptacle	NPX-100RFR	\$128.00
NP38-12B	12 Volts / 38.0Ah	7.74 x 6.50 x 6.89	Nut & Bolt	NP38-12B	\$125.00
NP38-12R	12 Volts / 38.0Ah	7.74 x 6.50 x 6.89	Receptacle	NP38-12R	\$125.00
NPX-150B	12 Volts / 40.0Ah	7.76 x 6.50 x 6.89	Nut & Bolt	NPX-150B	\$180.00
NPX-150R	12 Volts / 40.0Ah	7.76 x 6.50 x 6.89	Nut & Bolt	NPX-150R	\$180.00
NPX-150RFR	12 Volts / 40.0Ah	7.76 x 6.50 x 6.89	Nut & Bolt	NPX-150RFR	\$180.00
NP65-12FR	12 Volts / 65.0Ah	13.78 x 6.54 x 6.85	Nut & Bolt	NP65-12FR	\$290.00

# NICKEL CADMIUM BATTERIES

## CYLINDRICAL CELLS

MANUFACTURER	VOLTAGE / CAPACITY	SIZE	DIMENSIONS (mm)	R&D PART	LIST PRICE
Panasonic	1.2 Volts / 80mAh	N	12.0 x 30.0	P18N	\$2.50
Sanyo	1.2 Volts / 110mAh	AAAA	8.0 x 42.5	N120TA	\$2.50
Sanyo	1.2 Volts / 50mAh	1/3 AAA	10.5 x 15.8	N50AAA	\$2.50
Vinnic	1.2 Volts / 300mAh	AAA	10.5 x 44.5	N300AAA	\$2.80
Sanyo	1.2 Volts / 110mAh	1/3 AA	14.5 x 17.5	N110AA	\$2.40
Sanyo	1.2 Volts / 270mAh	2/3AA	14.5 x 28.2	N270AA	\$3.00
Sanyo	1.2 Volts / 700mAh	AA	14.3 x 50.2	N700AAC	\$2.45
Sanyo	1.2 Volts / 1100mAh	AA	14.3 x 50.3	KR1100AAU	\$3.00
Sanyo	1.2 Volts / 1200mAh	5/4 AA	14.5 x 64.5	KR1200AAE	\$3.25
Sanyo	1.2 Volts / 225mAh	1/3A	15.9 x 15.9	N225AE	\$2.50
Sanyo	1.2 Volts / 600mAh	2/3A	17.0 x 28.5	KR600AE	\$3.30
Sanyo	1.2 Volts / 1200mAh	4/5A	17.0 x 43.0	KR1200AUL	\$3.50
Sanyo	1.2 Volts / 1400mAh	A	17.0 x 50.0	KR1400AE	\$4.90
Sanyo	1.2 Volts / 1700mAh	A	17.0 x 49.5	KR1700AU	\$4.50
Vinnic	1.2 Volts / 600mAh	1/2 Sub C	22.6 x 25.9	N1/2SC	\$3.80
Sanyo	1.2 Volts / 1250mAh	3/4 Sub C	22.5 x 34.0	N1250SCR	\$4.20
Sanyo	1.2 Volts / 1200mAh	Sub C	22.9 x 43.0	N1200SCK	\$6.00
Sanyo	1.2 Volts / 1500mAh	Sub C	22.9 x 43.0	KR1500SC	\$4.70
Sanyo	1.2 Volts / 1300mAh	Sub C	22.9 x 43.0	N1300SCR	\$4.00
Sanyo	1.2 Volts / 1800mAh	Sub C	22.9 x 43.0	KR1800SCE	\$5.95
Saft	1.2 Volts / 1800mAh	Sub C	22.2 x 42.2	VRE Cs 1800	\$5.95
Sanyo	1.2 Volts / 1900mAh	Sub C	22.9 x 43.0	NC1900SCR	\$6.00
Vinnic	1.2 Volts / 750mAh	1/2 C	24.9 x 25.9	N1/2C	\$6.30
Vinnic	1.2 Volts / 1500mAh	2/3C	25.8 x 31.0	N2/3C	\$5.00
Sanyo	1.2 Volts / 2000mAh	C	26.0 x 50.0	N2000CK	\$7.00
Saft	1.2 Volts / 2400mAh	C	25.3 x 49.5	VRE C	\$6.65
Sanyo	1.2 Volts / 3000mAh	C	26.0 x 50.0	N3000CR	\$8.00
Saft	1.2 Volts / 2300mAh	1/2 D	32.3 x 36.8	VRE 1/2D	\$6.00
Saft	1.2 Volts / 4500mAh	D	32.3 x 58.6	VRE D	\$9.50
Sanyo	1.2 Volts / 4000mAh	D	33.2 x 60.0	KR4400D	\$9.50
Saft	1.2 Volts / 5500mAh	D	33.2 x 58.6	VRE D5500	\$10.00
Saft	1.2 Volts / 7000mAh	F	32.4 x 91.1	VT F	\$14.90

## CYLINDRICAL CELLS WITH POSITIVE BUTTON

MANUFACTURER	VOLTAGE / CAPACITY	SIZE	DIMENSIONS (mm)	R&D PART	LIST PRICE
Sanyo	1.2 Volts / 200mAh	AAA	10.9 x 45.7	5579	\$2.80
Sanyo	1.2 Volts / 700mAh	AA	14.5 x 50.0	5397	\$2.65
Sanyo	1.2 Volts / 1800mAh	Sub C	22.9 x 42.9	5853	\$4.90
Saft	1.2 Volts / 2400mAh	C	25.9 x 50.0	5403	\$6.85
Sanyo	1.2 Volts / 4300mAh	D	33.3 x 61.2	5703	\$7.25
Saft	1.2 Volts / 7000mAh	F	33.2 x 90.9	5856	\$15.10

## CYLINDRICAL CELLS WITH SOLDER TABS

MANUFACTURER	VOLTAGE / CAPACITY	SIZE	DIMENSIONS (mm)	R&D PART	LIST PRICE
Sanyo	1.2 Volts / 200mAh	AAA	10.5 x 44.5	5620	\$3.00
Sanyo	1.2 Volts / 700mAh	AA	14.5 x 48.3	5857	\$2.65
Sanyo	1.2 Volts / 1800mAh	Sub C	22.5 x 43.0	5854	\$4.90
Saft	1.2 Volts / 2400mAh	C	25.8 x 50.0	5404	\$6.85
Saft	1.2 Volts / 4300mAh	D	33.0 x 61.0	5855	\$9.70

## BUTTON CELLS

MANUFACTURER	VOLTAGE / CAPACITY	DIMENSIONS (mm)	R&D PART	LIST PRICE
60DK, N65BC	1.2 Volts / 65mAh	15.5 X 6.5	N65BC	\$1.60

# NICKEL CADMIUM BATTERIES

## NICD ASSEMBLIES

CELL SIZE - TYPE	VOLTAGE / CAPACITY	CONFIG	TERMINATION	R&D PART	LIST PRICE
AA - 1 x 2	2.4 Volts / 700mAh	A	Solder tabs	5001	\$6.95
AA - 1 x 3	3.6 Volts / 700mAh	A	Solder tabs	5068	\$11.00
AA - 1 x 4	4.8 Volts / 700mAh	A	Solder tabs	5150	\$12.00
AA - 1 x 4	4.8 Volts / 700mAh	A	Wires	5250	\$18.00
AA - 1 x 5	6 Volts / 700mAh	A	Solder tabs	5149	\$15.00
AA - 1 x 6	7.2 Volts / 700mAh	A	Wires	5332	\$30.00
AA - 1 x 9	10.8 Volts / 700mAh	A	Wires	5697	\$20.00
AA - 2 x 2	4.8 Volts / 700mAh	C	Solder tabs	5472	\$12.50
AA - 2 x 3	7.2 Volts / 700mAh	B	Solder tabs	5700	\$12.85
AA - 2 x 4	9.6 Volts / 700mAh	B	Wires	5736	\$26.00
AA - 2 x 5	12 Volts / 700mAh	B	Wires	5171	\$36.00
AA - 2 cell stack	2.4 Volts / 700mAh	E	Button	5621	\$15.00
AA - 3 cell stack	3.6 Volts / 700mAh	E	Solder tabs	5180	\$10.00
AA - 2 double stacks	4.8 Volts / 700mAh	F	Wires	5872	\$14.00
Sub C - 1 x 3	3.6 Volts / 1800mAh	A	Wires	5589	\$21.00
Sub C - 1 x 4	4.8 Volts / 1800mAh	A	Solder tabs	5017	\$21.00
Sub C - 1 x 5	6 Volts / 1800mAh	A	Wires	5202	\$27.00
Sub C - 1 x 6	7.2 Volts / 1800mAh	A	Solder tabs	5294-I	\$45.00
Sub C - 1 x 10	12 Volts / 1800mAh	A	Wires	5438	\$51.00
Sub C - 2 x 3	7.2 Volts / 1800mAh	B	Solder tabs	5641	\$30.00
Sub C - 2 x 5	12 Volts / 1800mAh	B	Solder tabs	5807	\$60.00
Sub C - 2 cell stack	2.4 Volts / 1800mAh	E	Solder tabs	5124	\$13.00
Sub C - 4 cell stack	4.8 Volts / 1800mAh	E	Solder tabs	5411	\$19.00
Sub C - 4 double stacks	9.6 Volts / 1800mAh	F	Solder tabs	5645	\$36.00
C - 1 x 2	2.4 Volts / 2400mAh	A	Solder tabs	5537	\$15.00
C - 1 x 3	3.6 Volts / 2400mAh	A	Solder tabs	5506	\$18.00
C - 1 x 5	6 Volts / 2400mAh	A	Solder tabs	5508	\$25.00
C - 1 x 6	7.2 Volts / 2400mAh	A	Solder tabs	5814	\$28.00
C - 2 x 3	7.2 Volts / 2400mAh	B	Solder tabs	5168	\$35.00
D - 1 x 3	3.6 Volts / 5000mAh	A	Wires	5826-I	\$35.00
D - 1 x 5	6 Volts / 4300mAh	A	Solder tabs	5352	\$57.00
D - 2 cell stack	2.4 Volts / 4300mAh	E	Solder tabs	5006	\$21.50
V40H - 2 cell stack	2.4 Volts / 40mAh	E	PC pins	5724	\$12.00
V80H - 2 cell stack	2.4 Volts / 60mAh	E	PC pins	5842	\$12.00
V80H - 2 cell stack	2.4 Volts / 60mAh	E	PC Pins 2 pos, 1 neg	5902	\$12.50
V80H - 3 cell stack	3.6 Volts / 60mAh	E	PC pins	5488	\$15.00
V80H - 4 cell stack	4.8 Volts / 70mAh	E	PC Pins 2 pos, 1 neg	5602	\$9.50
V150H - 3 cell stack	3.6 Volts / 100mAh	E	PC pins	5840	\$15.00
V150H - 3 cell stack	3.6 Volts / 150mAh	E	PC Pins 2 pos, 1 neg	5457	\$10.00
V150H - 4 cell stack	4.8 Volts / 110mAh	E	PC Pins 2 pos, 1 neg	5590	\$11.25
V300H - 3 cell stack	3.6 Volts / 320mAh	E	PC pins	5819	\$12.00

# NICKEL METAL HYDRIDE BATTERIES

## 9 VOLT CELLS

MANUFACTURER	VOLTAGE / CAPACITY	SIZE	DIMENSIONS (mm)	R&D PART	LIST PRICE
Varta V6/8	7.2 Volts / 180mAh	9V	26.5 x 17.5 x 48.5	5399	\$9.45
Energizer NH22	8.4 Volts / 150mAh	9V	26.5 x 17.5 x 48.5	5668	\$12.00
Varta V7/8	8.4 Volts / 180mAh	9V	26.5 x 17.5 x 48.5	5398	\$9.45
Varta	9.6 Volts / 170mAh	9V	26.5 x 17.5 x 48.5	6393	\$16.25

## CYLINDRICAL CELLS

MANUFACTURER	VOLTAGE / CAPACITY	SIZE	DIMENSIONS (mm)	R&D PART	LIST PRICE
Vinnic	1.2 Volts / 100mAh	1/3AAA	10.5 x 15.0	VH100	\$3.00
Vinnic	1.2 Volts / 300mAh	2/3AAA	10.5 x 29.0	VH300	\$3.00
FDK America	1.2 Volts / 730mAh	AAA	10.5 x 44.5	HR-AAAU	\$3.00
Vinnic	1.2 Volts / 250mAh	1/3AA	14.5 x 15.0	VH250	\$3.00
Varta	1.2 Volts / 500mAh	1/2AA	14.5 x 17.5	VH500	\$3.00
Vinnic	1.2 Volts / 650mAh	2/3AA	14.5 x 30.0	VH650	\$3.00
Vinnic	1.2 Volts / 1100mAh	2/3A	17.0 x 28.5	VH1100	\$5.00
FDK America	1.2 Volts / 115mAh	4/5AA	14.5 x 43.0	HHR120AA	\$4.50
FDK America	1.2 Volts / 1650mAh	AA	14.5 x 50.0	HR-AAU	\$3.00
FDK America	1.2 Volts / 2100mAh	4/5A	17.0 x 43.5	HR-4/5AU	\$5.95
FDK America	1.2 Volts / 2700mAh	A	17.0 x 50.0	HR-AU	\$5.00
FDK America	1.2 Volts / 4000mAh	4/3A	17.0 x 67.0	HR-4/3A	\$6.00
FDK America	1.2 Volts / 4500mAh	Fat 4/3A	17.0 x 67.0	HR-4/3FAU	\$7.00
Panasonic	1.2 Volts / 4200mAh	Fat 4/3A	18.2 x 67.0	HHR450A	\$7.00
Panasonic	1.2 Volts / 2000mAh	4/5 Sub C	23.0 x 34.0	HHR200SCP	\$6.50
FDK America	1.2 Volts / 3000mAh	Sub C	23.0 x 43.0	HR-SCU	\$6.00
Vinnic	1.2 Volts / 4000mAh	C	29.5 x 50.0	VH4000C	\$12.00
Tenergy	1.2 Volts / 5000mAh	C	29.5 x 50.0	VH5000C	\$12.00
FDK America	1.2 Volts / 10000mAh	D	33.0 x 60.0	VH D	\$30.00
Saft	1.2 Volts / 15000mAh	F	32.4 x 91.1	VH FL	\$45.00

## CYLINDRICAL CELLS WITH POSITIVE BUTTON

TYPE	VOLTAGE / CAPACITY	SIZE	DIMENSIONS (mm)	R&D PART	LIST PRICE
FDK America	1.2 Volts / 700mAh	AAA	10.5 x 44.5	5579-NiMH	\$3.00
FDK America	1.2 Volts / 1000mAh	AAA	10.5 x 44.5	HR-4U 1000	\$4.85
FDK America	1.2 Volts / 1600mAh	AA	14.5 x 50.0	5397-NiMH	\$3.00
FDK America	1.2 Volts / 2500mAh	AA	14.5 x 50.0	HR-3U 2500	\$5.00
FDK America	1.2 Volts / 3000mAh	Sub C	23.0 x 43.0	5853-NiMH	\$6.00
Vinnic	1.2 Volts / 3500mAh	C	29.5 x 50.0	5403-NiMH	\$12.00
Saft	1.2 Volts / 7500mAh	D	33.0 x 60.0	5703-NiMH	\$5.00

## VARTA BUTTON CELLS

TYPE	VOLTAGE / CAPACITY	SIZE	DIMENSIONS (mm)	R&D PART	LIST PRICE
V15H	1.2 Volts / 16mAh		11.5 x 3.10	V15H	\$1.60
V40H	1.2 Volts / 43mAh		11.5 x 5.35	V40H	\$1.25
V80H	1.2 Volts / 80mAh		15.5 x 6.5	V80H	\$1.20
V150H	1.2 Volts / 180mAh		14.1 x 25.6 x 5.85	V150H	\$2.50
V250H	1.2 Volts / 250mAh		25.0 x 6.7	V250H	\$1.75
CP300H	1.2 Volts / 300mAh		25.1 x 7.55	V300H	\$1.50
V350H	1.2 Volts / 380mAh		25.0 x 8.8	V350H	\$2.00
V450HR	1.2 Volts / 450mAh		5.6 x 24.1 x 34.1	V450HR	\$3.50

## MEMORY BACKUP

TYPE	VOLTAGE / CAPACITY	SIZE	DIMENSIONS (mm)	R&D PART	LIST PRICE
3/V15H	3.6 Volts / 15mAh		10.6 x 12.4 x 12.4	6050	\$6.00
2/V80H	2.4 Volts / 80mAh		13.6 x 16.0 x 16.0	6188	\$6.50
3/V80H	3.6 Volts / 80mAh		19.0 x 16.0 x 16.0	5488-NiMH	\$15.00
3/V150H	3.6 Volts / 150mAh		40.3 x 22.2 x 16.0	5457	\$10.00
5/V150H	6 Volts / 150mAh		40.3 x 22.2 x 40.0	6080	\$11.50

# LITHIUM-ION

## COIN CELLS

TYPE	VOLTAGE/CAPACITY	L x W x H (in)	R&D PART	LIST PRICE
LIR1620	3.6 Volt / 11mAh	16.0 Diameter x 2.0	LIR1620	\$6.50
LIR2016	3.6 Volt / 15mAh	20.0 Diameter x 1.6	LIR2016	\$6.50
LIR2025	3.6 Volt / 30mAh	20.0 Diameter x 2.5	LIR2025	\$6.50
LIR2032	3.6 Volt / 40mAh	20.0 Diameter x 3.2	LIR2032	\$6.50
LIR2430	3.6 Volt / 65mAh	24.5 Diameter x 3.0	LIR2430	\$6.50
LIR2450	3.6 Volt / 120mAh	24.5 Diameter x 5.0	LIR2450	\$6.50
LIR3048	3.6 Volt / 230mAh	30.0 Diameter x 4.8	LIR3048	\$6.50

Secondary  
VRLA

## MISCELLANEOUS BATTERIES

MANUFACTURER	MODEL	VOLTAGE / AH	R&D PART	LIST PRICE
<b>CAMCORDER AND DIGITAL CAMERAS</b>				
Canon	BP-4H	4.8 Volts / 150mAh	CAM-NB4H	\$22.00
Canon	BP-511	7.2 Volts / 1200mAh	CAM-BP511	\$28.00
Canon	BP-E77, BP-722	6 Volts / 2000mAh	CAM-290	\$20.00
Canon	NB-1L	3.7 Volts / 750mAh	CAM-NB1LH	\$20.00
Canon	NB-2L	7.2 Volts / 1000mAh	CAM-NB2L	\$24.00
Canon	NB-4L	4.8 Volts / 750mAh	CAM-NB4L	\$22.00
Canon	NB-5L	3.7 Volts / 900mAh	CAM-NB5L	\$20.00
Canon	NB-6L	3.7 Volts / 1000mAh	CAM-NB6L	\$19.00
Canon	NB-7L	7.4 Volt / 1050mAh	CAM-NB7L	\$25.00
Fuji	NP-40	3.6 Volts / 650mAh	CAM-NP40	\$20.00
Fuji	NP-60	3.7 Volts / 900mAh	CAM-NP60	\$20.00
Kodac	DX3600, KAA2HR	2.4 Volts / 1800mAh	CAM-KAA2	\$12.00
Multiple	3 Way Universal	6 Volts / 2000mAh	CAM-UN20NMH	\$24.50
Nikon	EN-EL1	7.4 Volts / 700mAh	CAM-775	\$23.00
Nikon	EN-EL3E	7.4 Volts / 1500mAh	CAM-ENEL3E	\$50.00
Olympus	LI-42B	3.7 Volts / 700mAh	CAM-LI42B	\$19.00
Panasonic	2012D, BP-50	12 Volts / 2000mAh	CAM-350	\$28.00
Panasonic	BP-80, BP-88	12 Volts / 2300mAh	CAM-322	\$31.00
Panasonic	CGA-S007	3.7 Volts / 1000mAh	CAM-S007	\$20.00
Panasonic	PVBP-15	6 Volts / 4000mAh	CAM-694NMH	\$35.00
Panasonic	PVBP-15, 17	6 Volts / 1200mAh	CAM-10	\$21.00
Panasonic	PVBP-15, 17	6 Volts / 2000mAh	CAM-10NMH	\$26.00
RCA / Hitachi	VHS	10 Volts / 2000mAh	CAM-567	\$28.00
Sharp	BT-77	6 Volts / 2000mAh	CAM-252NMH	\$26.00
Sony	NP-BG1	3.6 Volts / 960mAh	CAM-BG1	\$41.00
Sony	NP-66, NP-77, NP-77H	6 Volts / 4000mAh	CAM-577NMH	\$35.00
Sony	NP-F550	7.2 Volts / 1550mAh	CAM-F550	\$64.00
Sony	NP-F550, NP-F750	7.2 Volts / 3100mAh	CAM-F750	\$47.00
Sony	NP-FM30	7.2 Volts / 1100mAh	CAM-FM50	\$37.00
Many others available if you don't see your model listed, please call Customer Service or check our website.				

## CELLULAR PHONES & TABLETS

Apple	IPad	3.7 Volt / 6800mAh	LAP-IPAD	\$47.00
Apple	IPad2	3.7 Volt / 7200mAh	LAP-IPAD2	\$55.00
Apple	IPhone 3rd Generation	3.7 Volt / 2250mAh	PDA291Li	\$28.00
Apple	IPhone 4th Generation	3.7 Volt / 1420mAh	PDA298Li	\$32.00
Apple	IPhone 4S	3.7 Volt / 1450mAh	CEL-IP4S	\$29.00
Apple	IPhone 5	3.7 Volt / 1440mAh	CEL-IP5	\$32.50
AT&T	LG CU500, 500V, SBPP0015001	3.7 Volts / 700mAh	CEL-CU500	\$18.00
Audiovox	BTR7025, CDM120, 220, 7025, 7075	3.7 Volts / 750mAh	CEL-CDM7025	\$18.00
Blackberry	Curve 8900 series, Storm 9500 series	3.7 Volt / 1400mAh	CEL-9500	\$20.00
Blackberry	Bold Torch 9220, 9900, 9930, 9850, 9860	3.7 Volt / 1200mAh	CEL-9900	\$28.00
HTC	Android 6425, Rezound	3.7 Volt / 1550mAh	CEL-BTR6425	\$22.00
HTC	Desire, Nexus One	3.7 Volt / 1400mAh	CEL-A8181	\$19.00
HTC	Eternity, Titan, X310E, 35H00170-01M	3.7 Volt / 1400mAh	CEL-X310E	\$19.00
HTC	Raider 4G, Holiday, X710E	3.7 Volt / 1400mAh	CEL-X710	\$19.00
HTC	Shadow, C750	3.7 Volt / 800mAh	CEL-C750	\$19.00
HTC	Shadow 2, 35H0063-13M	3.7 Volt / 1100mAh	CEL-SHDW09	\$19.00
HTC	Touch Diamond 2, 35H00125-07M, 11M	3.7 Volt / 1100mAh	CEL-TCHDIA2	\$18.00
HTC	Touch Diamond , 35H00113-003, 03MM, 11M	3.7 Volt / 900mAh	CEL-TCHDIA	\$18.00

## MISCELLANEOUS BATTERIES

MANUFACTURER	MODEL	VOLTAGE / AH	R&D PART	LIST PRICE
<b>CELLULAR PHONES &amp; TABLETS...continued</b>				
LG	LG C2000, SBPL0076308, SBPL0080201	3.7 Volts / 900mAh	CEL-C2000	\$17.00
LG	LG VX6100, SBPL0077108, 0078401, 0081001, 0081101, 81901, 82001, 82101	3.7 Volts / 900mAh	CEL-VX6100	\$15.00
LG	My Touch Q, C800	3.7 Volt / 2400mAh	CEL-C800	\$29.00
LG	GW620, 820, 825, 880, GT540, LGIP-400N	3.7 Volt / 1000mAh	CEL-GW820	\$20.00
LG	Optimus	3.7 Volt / 1300mAh	CELL-P990	\$17.00
LG	P509 Optimus C, M, S, T, U, Thrive	3.7 Volt / 1000mAh	CEL-GW820	\$20.00
LG	P930, Optimus LTE, BL-49KH, Spectrum	3.7 Volt / 1300mAh	CELL-P930	\$20.00
LG	VN250, 530, Cosmos, Octane, SBPP0026903	3.7 Volt / 1100mAh	CEL-VN530	\$20.00
LG	BST L1400, L1400i, SBPL0072179	3.7 Volts / 750mAh	CEL-L1400	\$18.00
Motorola	Droid 2	3.7 Volt / 2700mAh	CEL-A955D	\$28.00
Motorola	Droid 3, XT860, 862, 882, 883, 8F6X	3.7 Volt / 1800mAh	CEL-XT882	\$25.00
Motorola	V325, SNN5765A, 5766, 5767, 5771, 5783	3.7 Volts / 750mAh	CEL-V325	\$15.00
Motorola	Razr V3, BR50, SSN5696, 5777, 5794, 5797	3.7 Volts / 600mAh	CEL-135LI	\$18.00
Motorola	Razr V3, BR50, BR56 High Capacity (Black)	3.7 Volts / 1100mAh	CEL-135LI-HCBK	\$22.00
Motorola	Razr V3, BR50, BR56 High Capacity (Silver)	3.7 Volts / 1100mAh	CEL-135LI-HCSV	\$22.00
Motorola	i550 Plus, NTN8971, XUL1100	4.8 Volts / 1300mAh	CEL-I550	\$18.00
Motorola	I710, I730, I733, I860, V60, V65 Series	3.7 Volts / 750mAh	CEL-I730	\$18.50
Motorola	V710, SNN5615, SNN5760A	3.7 Volts / 650mAh	CEL-V710	\$15.00
Motorola	V710, SNN5615, SNN5760A	3.7 Volts / 1300mAh	CEL-V710-HC	\$19.25
Motorola	V170, 171, 173, 176, 177, SNN5749A	3.7 Volts / 850mAh	CEL-V170	\$18.00
Motorola	A630, C975, 980, V975, 980, 1050, E1000	3.7 Volts / 750mAh	CEL-E1000	\$19.25
Motorola	V220, AANN4285, AANN4285B	3.7 Volts / 850mAh	CEL-V220	\$14.00
Motorola	IDEN 50, 60, 85, 90, 95 V60 Series	3.7 Volts / 1000mAh	CEL-94LI	\$18.00
Motorola	BC50, 60, L2, L6, L7, SSN5768, SSN5779, V8	3.7 Volts / 650mAh	CEL-L6	\$16.50
Motorola	Candid, Dorado, KX12, 13, 16, 160,	3.7 Volts / 900mAh	CEL-KX16	\$19.25
Nokia	3390, BLC-2, BMC-2	3.7 Volts / 1000mAh	CEL-105LI	\$15.25
Samsung	SGH-T209, X909, SGH-X495, X496, X497	3.7 Volts / 900mAh	CEL-X495	\$16.50
Sony Ericksson	BKB19320311, BST-37, K750, Z520 Series	3.7 Volts / 830mAh	CEL-Z520	\$14.50

Many others available, if you don't see your model listed please call Customer Service.

## CORDLESS PHONES & HEADSETS

AmericanTelecom	E30021CL, E30022CL, E30023CL, E30025CL, TL32100, TL92270, TL93270	2.4 Volt/750mAh	BATT-E30025CL	\$10.00
AT&T	2400, 5800 Series	2.4 Volts / 1500mAh	BATT-2431	\$14.00
AT&T	2414	3.6 Volts / 1500mAh	BATT-2414	\$15.00
AT&T	3300/3301	3.6 Volts / 600mAh	BATT-3300	\$9.50
AT&T	P-511, P-P511, HHR-P511	3.6 Volts / 1800mAh	BATT-511NMH	\$17.00
Cisco	PTE110	3.6 Volt/ 730mAh	BATT-3616	\$70.00
Clearone	592-158-001, 592-158-002, 592-158-003, GP180AAH6SML, GP220AAH6SML	7.2 Volts / 2100mAh	BATT-C1MAX	\$49.00
G.E.	2195140	3.6 Volts / 720mAh	BATT-27910	\$17.00
G.E.	2-5833GE3-A	3.6 Volts / 750mAh	BATT-2660	\$16.00
IBM	900FADS	3.6 Volts / 720mAh	BATT-IBM900	\$14.00
Panasonic	HHR-P505, P-P510, P-P510A	3.6 Volts / 1500mAh	BATT-14	\$16.00
Panasonic	KX-TG2300 Series	3.6 Volts / 830mAh	BATT-104	\$16.00
Panasonic	KX-TG2400 Series	2.4 Volts / 830mAh	BATT-105	\$16.00
Panasonic	KX-TG3000, 6000 Series	3.6 Volts / 700mAh	BATT-107	\$16.00
Panasonic	P-P511, 4250, GE TL26400	3.6 Volts / 850mAh	BATT-511	\$14.00
Panasonic	KX-TG2208, 2235	2.4 Volts / 1500mAh	BATT-513	\$13.00



## MISCELLANEOUS BATTERIES

MANUFACTURER	MODEL	VOLTAGE / AH	R&D PART	LIST PRICE
<b>CORDLESS PHONES &amp; HEADSETS...continued</b>				
Panasonic	KX-TC1400, KX-TC1700 Series	3.6Volt / 600mAh	BATT-ER1	\$5.95
Panasonic	E-2100 Series	3.6 Volts / 700mAh	BATT-2419	\$17.00
Plantronics	CS-50, CS-50-USB, CS-55, Cs-55H, CS- 60, CS351, CS361, 65358-01	3.7 Volts / 230mAh	BATT-CS50	\$20.00
Plantronics	CS70	3.7 Volt / 120mAh	BATT-CS70	\$19.00
Plantronics	CS540	3.7 Volt / 140mAh	BATT-CS540	\$20.00
Plantronics	PULSAR 590A	3.7 Volt / 300mAh	BATT-PUL590A	\$20.00
Sony	BP-T18 , SPP-ER1	3.6 Volts / 600mAh	BATT-ER1	\$11.00
Sony	BP-T21	2.4 Volts / 300mAh	BATT-21	\$4.95
Sony	BP-T23	3.6 Volts / 600mAh	BATT-23	\$13.00
Sony	BP-T24	3.6 Volts / 1000mAh	BATT-24	\$13.00
Sony	BP-T40	4 Volts / 500mAh	BATT-T40	\$14.00
Sony	SSP-N1000	2.4 Volt / 600mAh	BATT-50	\$5.95
Spectralink	BPX100, I640, Netlink I640, PTX110, RNP2400	3.6 Volts / 730mAh	BATT-BPX100	\$50.00
Spectralink	PTS330, PT/PTS/SPT360, PT/PTB/PTS/SKPT/SPT400, NPTB/PTB410	4.8 Volts / 730mAh	BATT-360	\$40.00
Spectralink	Link 6020, 8020, 8030,	3.7 Volt / 2500mAh	BATT-BPL300	\$65.00
S.W. Bell	GH2400	3.6 Volts / 600mAh	BATT-2400	\$14.00
Uniden	DECT1060	2.4 Volts / 800mAh	BATT-1002	\$13.00
Uniden	BBTG0645001	2.4 Volts / 700mAh	BATT-1008	\$13.00
Uniden	BBTY0545001, BT-0003, CLX Series	3.6 Volts / 800mAh	BATT-BT3	\$16.00
Uniden	BT-904	2.4 Volts / 900mAh	BATT-904	\$10.00
Uniden	TRU446 Series	3.6 Volts / 800mAh	BATT-446	\$13.00
Uniden	WXI377, BT-1001, BT-1004, BT-909	3.6 Volts / 750mAh	BATT-909	\$14.00
Vtech	6030, 6040, 6050 Series	2.4 Volts / 750mAh	BATT-6010	\$13.00
Vtech	80-5808-00-00, 89-1324-00-00	3.6 Volts / 750mAh	BATT-103	\$14.00
Vtech	910 ADL	3.6 Volts / 600mAh	BATT-23	\$13.00
Vtech	LS5105, LS5145, LS5146	3.6 Volts / 550mAh	BATT-5872	\$16.00

Many others available, if you don't see your model listed please call Customer Service.

### DOOR LOCKS

Best	Keypad	6 Volt / Alkaline	6219	\$12.00
Best	Keypad	6 Volt / Lithium	6219-Li	\$18.50
Intellikey Corp	1002255	10.8 Volt / 4.9Ah	6222	\$75.00

### GPS

Callaway	01008000134, 30200, upro, uprogd	3.7 Volt / 750mAh	PDA-289	\$23.00
Garmin	Approch G6, KF40F45DOD9X	3.7 Volt / 1250mAh	PDA-371Li	\$22.00
Garmin	Dezi 560, 361-00051-02	3.7 Volt / 1250mAh	PDA-358Li	\$22.00
Garmin	Nulink 2340, 2390, 361-00019-15	3.7 Volt / 1200mAh	PDA-359Li	\$21.00
Magellan	Maestro 1700, 335937010172	3.7 Volt / 750mAh	PDA363Li	\$20.00
Magellan	GPS750M, GPS750M Plus	12 Volt / 1800mAh	PDA-364Li	\$35.00
Magellan	Roadmate 2045	3.7 Volt / 750mAh	PDA-367Li	\$20.00
Magellan	Roadmate 3030	3.7 Volt / 750mAh	PDA-366Li	\$20.00
Magellan	Roadmate 3055, 3065	3.7 Volt / 750mAh	PDA-365Li	\$20.00
TomTom	Go 820, Go 825	3.7 Volt / 1000mAh	PDA-360Li	\$22.00
TomTom	Go 2435series, Go 2535 series	3.7 Volt / 1000mAh	PDA-361Li	\$22.00
TomTom	Eclipse	3.7 Volt / 1200mAh	PDA-362Li	\$22.00

Many others available, if you don't see your model listed please call Customer Service.

# BATTERY ANALYZERS & CHARGERS

## CHRISTIE

CASP MODEL	VOLTAGE RANGE	CHARGING		DISCHARGING		LIST PRICE
		POWER	CURRENT	POWER	CURRENT	
2500H	0 - 78 VDC	350 Watts	0 - 10 ADC	65 Watts	0 - 14 ADC	\$9,500.00

## SMBUS CHARGERS AND CONDITIONERS

SBS-4002-201

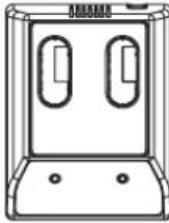

SBS-4002-202

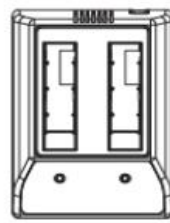

SBS-4002-204

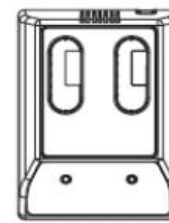

SMBus Charger and Reconditioner for 5071, 5071 B, 6291, 5981	SBS-4002-201	\$269.00
SMBus Charger and Reconditioner for 5963, 6139, 6139-A, 6181, 6191	SBS-4002-202	\$269.00
SMBus Charger and Reconditioner for 6140, 6140 A	SBS-4002-204	\$269.00

## PHYSIO-CONTROL

DESCRIPTION	R&D PART	LIST PRICE
3 Bay Charger and Conditioner for Physio-Control LifePak 12 (OEM)	99407-00002	\$2,450.00
Mobile Battery Service Station On-Vehicle Battery Charger / Conditioner for LP12	8210-0009	\$1,595.00

## ZOLL

DESCRIPTION	R&D PART	LIST PRICE
SurePower Charging Station	8050-0030-01	\$2,275.00
4 x 4 Charger & Tester for M-Series, AED Pro Series	8050-0012-01	\$1,545.00

## NI-MH & NI-CD CHARGERS

MFG	CELL SIZES	CHARGE TIME	R&D PART	LIST PRICE
GN National	AAA, AA (4 Bay Charger)	1 to 3 Hours	IC-34	\$20.00
GN National	9V, D, C, AA, AAA, N, Button cells	17 Minutes to 14 Hours	IC-6006	\$40.00
GN National	AAA, AA (10 Bay Charger)	1 to 3 Hours	IC-1029	\$60.00
GN National	9 Volt	10 Hours	WY-29V	\$7.50
Powersonic	1.2 to 14.4V / 500 to 5,000mAh	10 to 14 Hours - Indefinite Float	PSNCharger*	\$53.95

\*Please Specify Voltage, Amp Hour, and Termination when ordering the PSN Charger.

## SEALED LEAD ACID BATTERY CHARGERS

CHARGER OUTPUT VOLTAGE / CURRENT	USE WITH BATTERY VOLTAGE / CAPACITY	CHARGER TYPE	CHARGER MODEL	LIST PRICE
6.75/7.35V / 400mA	6 Volt / 1.0 - 5.0Ah	Automatic	PSC6300A-C	\$46.00
6.75/7.35V / 750mA	6 Volt / 2.0 - 10.0Ah	Automatic	PSC6500A	\$40.75
6.75/7.35V / 800mA	6 Volt / 2.0 - 10.0Ah	Automatic	PSC6800A	\$45.00
6.84/7.35V / 1000mA	6 Volt / 4.5 - 12.0Ah	Automatic	PSC61000A	\$54.25
6.75/7.35V / 4000mA	6 Volt / 20.0 - 40.0Ah	Automatic	PSC64000A	\$150.00
13.65V / 375mA	12 Volt / 1.0 - 5.0 Ah	Float	PSC12250F	\$46.00
13.68/14.70V / 300mA	12 Volt / 1.0 - 5.0 Ah	Automatic	PSC12300A	\$46.50
13.50/14.70V / 500mA	12 Volt / 2.0 - 10.0Ah	Automatic	PSC12500A	\$40.75
13.68/14.70V / 800mA	12 Volt / 4.0 - 12.0Ah	Automatic	PSC12800A	\$43.00
13.50/14.70V / 2000mA	12 Volt / 10.0 - 20.0Ah	Automatic	PSC122000A	\$110.00
13.50/14.70V / 4750mA	12 Volt / 12.0 - 40.0Ah	Automatic	PSC124000A	\$165.00
27.00/29.40V / 1000mA	24 Volt / 4.5 - 15.0Ah	Automatic	PSC241000A	\$146.00

# **BATTERY ANALYZERS & CHARGERS**

## **BATTERY TESTERS**

<b>DESCRIPTION</b>	<b>R&amp;D PART</b>	<b>LIST PRICE</b>
Quick Tester for NiCd, NiMH & Button Cells	BT-1	\$15.00
Quick tester for Alkaline and Lithium Primary Cells	BT-2	\$6.00

## **CAMCORDER STYLE SLA BATTERY CHARGERS**

<b>DESCRIPTION</b>	<b>MODEL</b>	<b>LIST PRICE</b>
Automatic 1` Bay Charger for R&D 5387, 5389 & 5771 (VA-2218)	VBC-100DP	\$65.00

MEDICAL LAMPS	MFG/MODEL	LAMP TYPE	R&D PART	PRICE
<b>WELCH ALLYN</b>				
Otoscope, Anoscope, Illuminator, Transilluminator, 20100, 21600, 26000, 26030, 38800, 40610, 41000, 41100,	WA00200	2.5 Volt - Incadescent	L016957	\$23.00
Ophthalmoscope 11600, 11605, 11610, 11710, 12400, 18000, 47300, ER Scope	WA03000	3.5 Volt - Halogen	L000342	\$34.00
Otoscope, Illuminator 20000, 21700, 20200, 20202, 25000, 25020, 25200, 26630, 27000, 27060, 28100, 41100, 43300	WA03100	3.5 Volt - Halogen	L000343	\$32.00
Otoscope, Illuminator 21110, 24000, 24011, 24020, 24031, 27200, 27250, 41110, Pocket Scope	WA03400	2.5 Volt - Halogen	L000344	\$35.00
Retinoscope 18100	WA03700	3.5 Volt - Halogen	L000345	\$66.00
Lamp	WA03800	3.5 Volt - Halogen	L000324	\$52.00
Lamp	WA03900	2.5 Volt - Halogen	L000346	\$44.00
Exam Lamp 48400, 48410	WA04100	14.5 Volt - Halogen	L000347	\$80.00
Exam Lamp 48700, Exam Light III	WA04200	35 Watt / 12 Volt - Halogen	L000348	\$66.00
Ophthalmoscope 11400, 11470, 11411 (Min of 6)	WA04400	2.5 Volt - Halogen	L000349	\$33.00
LS 135 Exam Light (Min of 6)	WA04430	35 Watt - Halogen	L031448	\$32.00
LS 150 Exam Light	WA04450	50 Watt - Halogen	L052067	\$58.00
Laryngoscope (Child) 664 size 1, 634 s 0-1, 680 s 0-1, 680 s 1-2, 692 s 1-2, 674 s 1, 684 s 0-1, 694 s 1-2	WA04700	2.5 Volt - Halogen	L000352	\$16.00
Laryngoscope (Adult) 664 size 2-4, 680 s 2-4, 634 s 2-4, 680 s 3-4, 682 s 3-4, 674 s 2-4, 694 s 3-4, 640 s 1, 640 s 2-4, 684 s 2-4, 40415 Transilluminator	WA04800	2.5 Volt - Halogen	L000353	\$16.00
Ophthalmoscope 11620, 11630, 11720, 11730, 11735	WA04900	3.5 Volt - Halogen	L000354	\$45.00
Fiberoptic, Laryngoscope 60713, 60813, 60814, 60815, 60803, 60804	WA06000	2.5 Volt - Halogen	L000355	\$33.00
Ophthalmoscope, Audioscope 3, Screening Audiometer	WA06200	3.5 Volt - Halogen	L000357	\$53.00
Surgical Lamp 44100, 44110	WA06300	12 Volt - Halogen	L000358	\$29.00
LS 200, 44200 Exam Light	WA06400	12 Volt - Halogen	L000359	\$91.00
Macroview, Digital Marcoview	WA06500	3.5 Volt - Halogen	L038826	\$32.00
Penlight	WA07600	3.5 Volt - Halogen	L000361	\$26.00
Vaginal Speculum Illuminator 78000, Simoidoscope 73210, 73200	WA07800	6 Volt - Halogen	L000362	\$35.00
Lumiview 20520(Min of 6)	WA08500	3.6 Volt Halogen	L000367	\$62.00
Vaginal Speculum Illuminator, 78810, 78800	WA08800	4.5 Volt - Halogen	L032488	\$44.00
Projector 46100, 49500, 471000, Light Source, MF1 Solarc Headlight	WA09500	24 Watt - Metal Halide	L000399	\$459.00
Video Colposcope	WA09800	21 Watt - Solarc HID	L016973	\$367.00

<b>WELCH ALLYN SUBSTITUTES</b>				
Otoscope, Anoscope, Illuminator, Transilluminator	BO00200	2.5 Volt - Incadescent	L003851	\$6.00
Ophthalmoscope	BO03000	3.5 Volt - Halogen	L002735	\$10.00
Otoscope, Illuminator	BO03100	3.5 Volt - Halogen	L002736	\$12.00
Otoscope, Illuminator(Min of 6)	BO03400	2.5 Volt - Halogen	L003861	\$14.00
Retinoscope(Min of 6)	BO03700	3.5 Volt - Halogen	L002737	\$17.00
Lamp	BO03800	3.5 Volt - Halogen	L003862	\$11.00
Lamp	BO03900	2.5 Volt - Halogen	L003863	\$9.00
Exam Lamp	CL01309, 04100	14.5 Volt - Halogen	L006644	\$10.00

MEDICAL LAMPS	MFG/MODEL	LAMP TYPE	R&D PART	PRICE
<b>WELCH ALLYN SUBSTITUTES... continued from previous page</b>				
Exam Lamp	USEPN/04200	35 Watt / 12 Volt - Halogen	L001487	\$17.00
Ophthalmoscope	BO04400	2.5 Volt - Halogen	L003866	\$11.00
Laryngoscope (Child) (Min. 6/order)	BO04700	2.5 Volt - Halogen	L001041	\$6.00
Laryngoscope (Adult), Transilluminator	BO04800/CL949	2.5 Volt - Halogen	L001068	\$6.00
Ophthalmoscope	BO04900	3.5 Volt - Halogen	L002739	\$23.00
Fiberoptic, Laryngoscope	BO06000	2.5 Volt - Halogen	L003871	\$11.00
Ophthalmoscope, Audioscope 3, Screening Audiometer	BO06200	3.5 Volt - Halogen	L051787	\$11.00
Surgical Lamp 44100, 44110.	OS64425AX/06300	12 Volt - Halogen	L000882	\$12.00
Macroview, Digital Marcoview	BO06500	3.5 Volt - Halogen	L046860	\$12.00
Vaginal Speculum Illuminator	BO07800	6 Volt - Halogen	L002740	\$15.00
Lumiview 20520	BO08500	3.6 Volt Halogen	L003874	\$11.00
Vaginal Speculum Illuminator	BO08800	4.5 Volt - Halogen	L034800	\$15.00

<b>HEINE</b>				
Mini 2000 Dermatoscope	HEX01.88.034	2.5 Volt - Halogen	L002476	\$70.00
Fiber Optic Laryngoscope Handle	HEX01.88.035	2.5 Volt - Halogen	L002473	\$51.00
Alpha, Mini Fiber Optic Oscope	HEX01.88.037	2.5 Volt - Halogen	L002477	\$43.00
Mini 2000 Cliplamp, Combilamp, Mini 1000 Fibrilux	HEX01.88.041	2.5 Volt - Halogen	L002481	\$43.00
Alpha Ophthalmoscope, Mini 2000 Ophthalmoscope (Min of 6)	HEX01.88.043	2.5 Volt - Halogen	L002482	\$45.00
Mini 2000 Oscope	HEX01.88.056	2.5 Volt - Halogen	L002483	\$43.00
Mini 3000 Cliplamp, Combilamp	HEX01.88.107	2.5 Volt - Halogen	L065870	\$50.00
Mini-C Cliplamp	HEX01.88.108	2.5 Volt - Halogen	L065869	\$50.00
Otoscope Beta 200F.O. TL, K180 F.O. TL	HEX02.88.044	3.5 Volt - Halogen	L002493	\$59.00
Diagnostic Oscope TL	HEX02.88.049	3.5 Volt - Halogen	L002496	\$59.00
Delta 10 Dermatoscope TL (Min of 6)	HEX02.88.046	3.5 Volt - Halogen	L000322	\$59.00
BETA 200 Ophthalmoscope TL	HEX02.88.070	3.5 Volt - Halogen	L002498	\$59.00
K 180 (Kappa) Ophthalmoscope TL	HEX02.88.086	3.5 Volt - Halogen	L002502	\$56.00
HSL 150 Slit Lamp	HEX02.88.099	3.5 Volt - Halogen	L010780	\$59.00
Anoscope Kit, Sigmoscope	HEX04.88.060	5 Volt - Halogen	L002504	\$59.00
OMEGA idirects, SL 350 Headlight	HEX04.88.068	6 Volt - Halogen	L002505	\$117.00
UBL 100 Loupe Light (Min of 6)	HEX04.88.080	6 Volt - Halogen	L029226	\$71.00
Fiber Optic Projection HK 4000-100W	HEY96.15.103	12 Volt - Halogen	L002510	\$69.00
BETA 200 Oscope TLK180, Oscope TL,Lambda, 100 Retinometer TL, Finoff Transilluminator TL, Fiber Optic Laryngoscope Handle	HEX02.88.078	3.5 Volt - Halogen	L002500	\$59.00

<b>HEINE SUBSTITUTES</b>				
X01.88.035 (Min of 6)	BOX0188035	2.5 Volt - Halogen	L003902	\$12.00
X01.88.037 (Min of 6)	CL953NICKEL	2.5 Volt - Halogen	L001071	\$12.00
X01.88.042	BOX0188042	2.5 Volt - Halogen	L003904	\$14.00
X02.88.044	CL889	3.5 Volt - Halogen	L001036	\$15.00
X02.88.046	BOX0288046	2.5 Volt - Halogen	L049411	\$18.00
X02.88.070	BOX0288070	3.5 Volt - Halogen	L047362	\$14.00
X02.88.078	BOX0288078	3.5 Volt - Halogen	L052236	\$11.00
X04.88.068	BOX0488068	6 Volt - Halogen	L047210	\$26.00
X04.88.104	BOX0488104	6 Volt - Halogen	L083409	\$45.00

MEDICAL LAMPS	MFG/MODEL	LAMP TYPE	R&D PART	PRICE
<b>OPHTHALMIC</b>				
Fiberoptic Laryngoscope (Min of 6)	CL954GOLD	2.5 Volt - Halogen	L000610	\$24.00
Keeler 1514-P-1144, 1729-P-1023, Fiber Optic 3.5V, Practitioner 3.5V, Vista 3.5V	CL1341	3.5 Volt - Halogen	L029395	\$9.00
Keeler (1012P5006)	BT1012P5006	18 Watt / 6 Volt - Incandescent	L003947	\$110.00
Marco 101 Lensometer	BT25S11FRE17110	25 Watt / 110 Volt - Incandescent	L002754	\$4.00
Penlon Conventional Laryngoscope Adult 55091	CL1019	2.7 Watt / 3.7 Volt - Incandescent	L006640	\$3.00
Penlon Conventional Laryngoscope Child 55092	CL894, 04700	2.5 Volt - Halogen	L001041	\$6.00
Penlon 55094	CL0967	3 Volt	L029300	\$7.00
Propper Magnalume(Old)	HEX01.88.061	2.5 Volt - Halogen	L002487	\$32.00
Propper MMI, Superlume	HEX02.88.072	3.5 Volt - Halogen	L002499	\$59.00
Propper Pocket Magnalume	HEX02.88.101	3.5 Volt - Halogen	L065851	\$59.00
Propper LM22	HEX01.88.041	2.5 Volt - Halogen	L002481	\$43.00
Raush 00-8623-100	CL894, 04700	2.5 Volt - Halogen	L001041	\$6.00
Riester Ri-Mini F.O. 10500, 10502, 10504, 10505, 10506, 10600 Nasal Speculum, 10534, 10534-301	CL1663	2.5 Volt - Halogen	L048393	\$7.00
Riester Ri-Mini 10501, 10503, 10507, 10508, 10509, 10532	CL0894	2.5 Volt - Halogen	L067695	\$8.00

<b>PROJECTORS</b>				
Am. Optical, B&L, Nikon, Riechert	GE15511102120V	15 Watt / 125 Volt - Incandescent	L002808	\$2.00
Am. Optical, B&L, Riechert, Topcon Eye Chart	USCAX130VHAL	50 Watt / 115 Volt - Halogen	L001166	\$28.00
Am. Optical Projector 1215, 1217, 11082	GECAX	50 Watt / 120 Volt - Halogen	L008687	\$17.00
Burton 5000 Projector	GECAX	50 Watt / 120 Volt - Halogen	L008687	\$17.00
B&L 71-37-01, Acuchart Projector	GECAX	50 Watt / 120 Volt - Halogen	L008687	\$17.00
Marco 6006 Projector	GECAX	50 Watt / 120 Volt - Halogen	L008687	\$17.00
Mentor Brightness Acuity Tester	ME224506	2.7 Watt / 3.7 Volt - Incandescent	L002831	\$13.00
Topcon Projector CP-5D	GECAX	50 Watt / 120 Volt - Halogen	L008687	\$17.00

<b>SLIT LAMPS</b>				
Am. Optical, Reichert Slit Lamps	BT1468X	6 Volt - Incandescent	L004094	\$13.00
Am. Optical 1800 Slit Lamp	PX1096	30 Watt / 6 Volt - Incandescent	L014946	\$13.00
Burton 800, 850, 1000, L1000 Slit Lamp	BT3050F	6 Volt - Incandescent	L002757	\$29.00
Burton 800, 850, 1000, L1000 Slit Lamp	WK41318	6 Volt - Incandescent	L017205	\$25.00
Haag-Steit 900, BM900, (0900-09300) OEM bulb	HS900930	27 Watt / 4.5 Volt - Incandescent	L036245	\$58.00
Haag-Steit 900, BM900	USSM900930	27 Watt / 4.5 Volt - Incandescent	L046485	\$24.00
Keeler SL-16, SL-16 Type, SL-40HT, SL-40 Type	OS64251HLX	20 Watt / 6 Volt - Halogen	L000862	\$23.00
Marco GII, GIV, GXX, IV,	OS64260	12 Volt / 30 Watt - Halogen	L000864	\$17.00
Marco IIB, IIBBR, IIBPhoto, III, V, VG, Vphoto, VR	BT3050F	6 Volt - Incandescent	L002757	\$29.00
Mentor G10, GH12, SH12	BT3050F	6 Volt - Incandescent	L002757	\$29.00
Nikon CS2, FS2, FS3, NS1	OS64260	12 Volt / 30 Watt - Halogen	L000864	\$17.00
Topcon SL-3D, SL-3E, SL-5D, SL-6E Main Bulb	BT3050F	6 Volt - Incandescent	L002757	\$29.00
Topcon SL-1E, SL-2D, SL-2ED, SL-3E, TCRC45AN, TRCNW2 Main Bulb(40350-420700)	BTBY4034020700	20 Watt / 6 Volt - Halogen	L002762	\$23.00
Topcon SL-1E, SL-2D, SL-2ED, SL-3E, TCRC45AN, TRCNW2 Main Bulb(40340-420700)	CL1777	20 Watt / 6 Volt - Halogen	L054493	\$19.00
Topcon Slit Lamp SL-2E, S;3E, SL5E SL7E, SL8Z Fixation Bulb(40340-42110)	TP4035042110	6 Volt - Incandescent	L016190	\$52.00
Zeiss CS-1	USJC6V30WG4	30 Watt / 6 Volt - Halogen	L002142	\$10.00

MEDICAL LAMPS	MFG/MODEL	LAMP TYPE	R&D PART	PRICE
<b>SLIT LAMPS... continued from previous page</b>				
Zeiss 30SL	OS64260	12 Volt / 30 Watt - Halogen	L000864	\$17.00
Zeiss 100/16, 125/16	BT53Z	25 Watt / 6 Volt - Incandescent	L002767	\$28.00
Welch Allyn (Cover Glass) (FRB)	OS35MR16SP10C	35 Watt / 12 Volt - Halogen	L049563	\$5.00

<b>SURGICAL</b>				
ALM, Getinge Castle, H6950 (74000)Prismatic Optical	USSM-74000	120 Watt / 24 Volt - Halogen	L002455	\$19.00
ALM, Getinge Castle (74000)	BT505454J	120 Watt / 24 Volt - Halogen	L002766	\$19.00
ALM Exam Lamp (50067)(843067)	BTALM23V100W	100 Watt / 23 Volt - Halogen	L001087	\$25.00
ALM, Getinge Castle 72415	OSENH	250 Watt / 120 Volt - Halogen	L001462	\$11.00
ALM, Getinge Castle (516767)	USJCD24V60WDC	60 Watt / 24 Volt - Halogen	L002170	\$20.00
ALM, Getinge Castle, Daystar (49455)	USESP	150 Watt / 120 Volt - Halogen	L016426	\$13.00
ALM, Getinge Castle, Model 2310 (60976)	WKESR	100 Watt / 120 Volt - Halogen	L001520	\$9.00
ALM, Getinge Castle	OSETC	150 Watt /120 Volt - Halogen	L001543	\$14.00
Berchtold Chromophere C570, CZ906-24	HBCZ906-24	150 Watt / 24 Volt - Halogen	L010768	\$36.00
Berchtold Chromopher B680, B950, C450 old, CZ905-24	OS64638HLX	100 Watt / 24 Volt - Halogen	L000934	\$11.00
Berchtold Chromopher C450, C452, CZ905-22	HBCZ905-22	110 Watt / 22.8 Volt - Halogen	L079738	\$15.00
Berchtold Chromophere C952, D650, CZ907-22	HBCZ907-22	150 Watt / 22.8 Volt - Halogen	L001184	\$30.00
Berchtold Chromophere D510, D540, D660, E650, E805, CZ909-22	BT64465U	150 Watt / 22.8 Volt - Halogen	L004685	\$20.00
Berchtold Chromophere C571, C572, CZ908-24	OS64642HLX	150 Watt / 24 Volt - Halogen	L000936	\$5.00
Berchtold Chromophere D500, D550 Plus, D650 Plus, CZ908-22	BTM01081	150 Watt / 22.8 Volt - Halogen	L049788	\$18.00
Berchtold D300, CZ-955-12-04	OS64440	50 Watt / 12 Volt - Halogen	L000314	\$6.00
Brewer Featherlight Minor Pricedure Light 163001, 163002, 163003, 163003-10, 163003-9	GEEXNC	50 Watt / 12 Volt - Halogen	L001587	\$9.00
Brewer Exam Light 16100, 18100	WKFMW	35 Watt / 12 Volt - Halogen	L001859	\$2.00
Burton AIM-50, Outpatient, Outpatient II, Outpatient Plus	OS50MR16SP10C	50 Watt / 12 Volt - Halogen	L048480	\$6.00
Burton AIM-100	WKFMW	35 Watt / 12 Volt - Halogen	L001859	\$2.00
Burton Bilirubin Blanket, Cavatron Hand Held	OSDDL	150 Watt / 20 Volt - Halogen	L001192	\$10.00
Burton BrightSpot	GEQ20MR16SP12V	20 Watt / 12 Volt - Halogen	L002361	\$6.00
Burton Cool Spot, Cool Spot II, (0001191)	PHDDL	150 Watt / 20 Volt - Halogen	L001189	\$13.00
Burton Genesis Plus, Genie II, Genie Plus	OS64440AX	50 Watt / 12 Volt - Halogen	L000886	\$8.00
Burton Ultraviolet Exam Lamp	BTF4TFD	4 Watt - Fluorescent	L005503	\$4.00
Burton (000116)	PHEPZ	50 Watt / 13.8 Volt - Halogen	L001501	\$15.00
Burton (1006926 ASSY)	BT7113816	250 Watt / 120 Volt - Halogen	L004830	\$225.00
Castle 2410M	OSETC	150 Watt / 120 Volt - Halogen	L001543	\$14.00
Castle 2410MB, MDT2000 Series Surgical Lamp (516851)	USJDC24V60WDC	60 Watt / 24 Volt - Halogen	L002170	\$20.00
Castle Daystar	USESP	150 Watt / 120 Volt - Halogen	L016426	\$13.00
Hanalux Blue 30	BT053001BLUE30	50 Watt /24 Volt - Halogen	L046981	\$34.00
Hanalux London	BT018566	50Watt /22.8 Volt - Halogen	L002742	\$11.00
Hanalux Melbourne, Oslo	BT018769	40 Watt /22.8 Volt - Halogen	L002743	\$12.00
Hillrom Prima	HGBSS1089	180 Watt /22.7 Volt - Halogen	L047762	\$26.00
Maco Prima	BT018769	40 Watt /22.8 Volt - Halogen	L002743	\$12.00
Maquet Primalix	BTALM23V100W	100 Watt / 23 Volt - Halogen	L001087	\$25.00
Medical Illumination Centura	OSDDL	150 Watt / 20 Volt - Halogen	L001192	\$10.00
Medical Illumination Centura	OSEJA	150 Watt / 21 Volt - Halogen	L001369	\$10.00

MEDICAL LAMPS	MFG/MODEL	LAMP TYPE	R&D PART	PRICE
<b>SURGICAL... continued from previous page</b>				
Medical Illumination Centuion	OS64458AX	90 Watt / 12 Volt - Halogen	L000889	\$18.00
Medical Illumination Illuminator IV	USESP	150 Watt / 120 Volt - Halogen	L016426	\$13.00
Medical Illumination Med-Exam	BUQ150CLEDT120V	150 Watt / 120 Volt - Halogen	L002352	\$12.00
Medical Illumination Medi-Spot, Mini-Spot	OSENH	250 Watt / 120 Volt - Halogen	L001462	\$11.00
Medical Illumination V.E.D. Exam Light	OS64440AX	50 Watt / 12 Volt - Halogen	L000886	\$8.00
Medical Illumination V.E.D. Spotlight	USEYP	42 Watt / 12 Volt - Halogen	L001690	\$6.00
Midmark 355 Light 002-0529-00	OS64623HLX	100 Watt / 24 Volt - Halogen	L000924	\$6.00
Midmark 354 Exam Light, 015-1212-00	GEEKE	150 Watt / 21 Volt - Halogen	L001404	\$12.00
Midmark 015-1384-00, 152 Exam Light	WKFMW	35 Watt / 12 Volt - Halogen	L001859	\$2.00
Midmark 355 Minor Surgery Light	OS64623HLX	100 Watt / 24 Volt - Halogen	L000934	\$11.00
Hanalux Blue 30	BT053001BLUE30	50 Watt / 24 Volt - Halogen	L046981	\$34.00
Luxtek (001325)	OSDNF	150 Watt / 21 Volt - Halogen	L001218	\$19.00
Luxtek, Olympus, Ziess (58102)	OS64634HLX	150 Watt / 15 Volt - Halogen	L000931	\$9.00
Ohmeda BilliBlanket, Spot Phototherapy	OSDDL	150 Watt / 20 Volt - Halogen	L001192	\$10.00
Olympus CLK-4	OS64634HLX(EFR)	150 Watt / 15 Volt - Halogen	L000931	\$9.00
Ritter, Martin	OS64638HLX	100 Watt / 24 Volt - Halogen	L000934	\$11.00
Siemens (Hanalux), Ziess (15282)	BT018566	50 Watt / 23 Volt - Halogen	L002742	\$11.00
Skytron Steller Infinity Series H24501, Hospilite	WKB101028	50 Watt / 24 Volt - Halogen	L001088	\$29.00
Skytron Steller Infinity Series H24501, Hospilite	HGDKK50	50 Watt / 24 Volt - Halogen	L079739	\$19.00
Skytron (A1-101-28-1)	BTA1010281	40 Watt / 24 Volt - Halogen	L000670	\$29.00
Skytron (B1-010-28)	WKB101028	50 Watt / 24 Volt - Halogen	L001088	\$29.00
Skytron (B1-010-28)	HGDKK50	50 Watt / 24 Volt - Halogen	L079739	\$19.00
Skytron (B4-010-29)	USSMB401029	75 Watt / 24 Volt - Halogen	L002456	\$59.00
Skytron Argos Strobe(5-010-04)	STB5-010-04	Strobe	L035138	\$68.00
Skytron HA60 H24100 AR WC Argo (B5-011-32)	BT24V100WDKK	100 Watt / 24 Volt - Halogen	L004289	\$25.00
Skytron Universe SH52 (A1-510-01)	HGSH52	60 Watt / 24 Volt - Halogen	L047763	\$24.00
Skytron Universe II SH62(A1-420-10)	WKA142010	50 Watt / 24 Volt - Halogen	L033265	\$41.00
Steris/Amsco (P041517-091)	HG150P252SB120V	150 Watt / 120 Volt - Incandescent	L057958	\$18.00
Steris/Amsco Examiner 10	OSETC	150 Watt / 120 Volt - Halogen	L0001543	\$13.00
Steris/Amsco Quantum 300(P1292362-228)	BTP129362228	220 Watt / 22 Volt - Halogen	L000650	\$21.00
Steris/Amsco Polaris 22, Challenger 22, (P129249-001)	BTQ235T43	235 Watt / 33 Volt - Halogen	L002364	\$27.00
Steris/Amsco Polaris 22, Challenger 22, (P129249-001)	OS235T4QPPF33V	235 Watt / 33 Volt - Halogen	L027791	\$17.00
Steris Gemini (P129359-934)	BTP129359934	200Watt / 22 Volt - Halogen	L002330	\$89.00
Steris Harmony 500/700, LA, SQ140, SQ240(093926-04)	BT093926047	180 Watt / 20 Volt - Halogen	L036103	\$23.00
Steris Harmony LA300	BT093926113	100 Watt / 22 Volt - Halogen	L054869	\$85.00
Stryker Visum 450	BT505454J	120 Watt / 24 Volt - Halogen	L002766	\$19.00
Stryker Visum 450	USSM-74000	120 Watt / 24 Volt - Halogen	L002455	\$19.00
Zeiss 15282	OS646502	50 Watt / 22.8 Volt - Halogen	L045161	\$16.00

<b>ENDOSCOPIC (LIGHT SOURCES)</b>				
Xenon Short Arc (Cermax)	PE175BF	175 Watt - Xenon	L002579	\$424.00
Xenon Short Arc	PE150BF	150 Watt - Xenon	L002580	\$505.00
Xenon Short Arc, Y1064, CX-2300	PE300BF	300 Watt - Xenon	L002602	\$359.00
Xenon Short Arc, Y1829	PE300C-10F	300Watt - Xenon	L029711	\$550.00
Circon ACMI ALVI, MV9086, MV9087	OSDNF	150 Watt - Halogen	L001218	\$19.00
DaVince Intuitive, 57034, 57051, Surgical System	PE300C-10F	300 Watt - Xenon	L029711	\$581.00
Pentax EPK-I (Lamp Only)	LXCL1576	300 Watt - Xenon	L056668	\$960.00
Pilling Weck 300 watt	USUXR-300C	301 Watt - Xenon	LUXR300C	\$426.00
Olympus (58107) (58110) (58111) Xenon Short Arc, (Cermax) with timer	PE908510FPS	300 Watt - Xenon	L002578	\$503.00



MEDICAL LAMPS	MFG/MODEL	LAMP TYPE	R&D PART	PRICE
<b>ENDOSCOPIC (LIGHT SOURCES)... continued from previous page</b>				
Olympus MAJ524	BTMAJ525	1.7 Watt / 2.5 Volt - Halogen	L068054	\$23.00
Linvatec, Conmed LS7700	PE300C-10F	300Watt - Xenon	L029711	\$550.00
Luxtek Fiber Optic Headpiece	USELZ	150 Watt - Halogen	L001444	\$23.00
Luxtek 001325	OSDNF	150 Watt - Halogen	L001218	\$19.00
Smith & Nephew Dyonics 500LX	PEME300BF	300Watt - Xenon	LPEME300BF	\$650.00
Stryker Quantum 3000 (220-130-300)	OSHTI250W32STRY	270 Watt / 42 Volt - Metal Halide	L013437	\$734.00
Stryker X6000 (Lamp Only)	PE300BF	300 Watt - Xenon	L002602	\$359.00
Stryker X6000 (Module)	LXCL1287	300 Watt - Xenon	L056665	\$793.00
Stryker X7000 (Lamp Assembly)	LXCL1571	300 Watt - Xenon	L056667	\$910.00
Stryker X7000 (Lamp Only)	LXCL1492	300 Watt - Xenon	L056756	\$770.00
Stryker X7000 (Lamp Only)	PE300C-10F	300 Watt - Xenon	L029711	\$550.00
Stryker X8000 (Lamp Assembly)	LXCL1567		L056666	\$868.00
Stryker X8000 (Lamp Only)	LXCL1495	300 Watt - Xenon	L056755	\$769.00
Sunoptics Cuda C150, HLS150T, MD150T	OSEJA	150 Watt - Halogen	L001369	\$10.00
Sunoptics Cuda HLS250T	OSELK	250 Watt - Halogen	L001423	\$8.00
Sunoptics Cuda SYC0020	OSHTI250W/32CUDA	270 Watt - Halogen	L013434	\$536.00
Sunoptics Cuda Titan 400 (Module)	LXCL1585	300 Watt - Xenon	L060190	\$1,190.00
Techniquip FOI-150, Mille Luce, 21AC, 21DC,	GEEKE	150 Watt / 21 Volt - Halogen	L001404	\$12.00
Techniquip FOI-250	OS64653HLX	250 Watt / 24 Volt - Halogen	L000938	\$11.00
Vitalcor Sunbeam Light Source	PE300C-10F	300 Watt - Xenon	L029711	\$550.00
Welch Allyn MS24, MS48	WAAL1824	18 Watt / 24 Volt - Metal Halide	L017014	\$457.00
Zeiss 58102	OS64634HLX (EFR)	150 Watt - Halogen	L000931	\$9.00

<b>MICROSCOPE</b>				
American Optical 583	GE778	20 Watt / 6 Volt - Halogen	L001005	\$10.00
Am. Optical 1031, 1820, 1130, H10, H110	GE788	20 Watt / 6 Volt - Halogen	L001015	\$10.00
Am. Optical, B&L, Marco, Swift (Min of 10)	BT1493	17.8 Watt / 6.5 Volt - Incandescent	L004102	\$1.00
Am. Optical, Jena, Leitz, Nikon, Olympus, Zeiss	OS64625HLX	100 Watt / 12 Volt - Halogen	L000926	\$3.00
Am. Optical 583	GE778	20 Watt / 6 Volt - Halogen	L001005	\$10.00
Am. Optical 1031, 1130, H10, H110, 1820	GE788	20 Watt / 6 Volt - Halogen	L001015	\$10.00
Am. Optical 363, 364, 369, 655, 3000, 3060, K1567A, K1730, K1886, L10, Starlight External Illuminator	BT1460	17.8 Watt / 6.5 Volt - Incandescent	L002747	\$3.00
Am. Optical, Reichert, Swift	BT1460X	17.8 Watt / 6.5 Volt - Incandescent	L004091	\$5.00
Bausch & Lomb 31-27-12, 31-27-65, 31-32-15, 31-32-16, 31-32-18, 31-32-42, 31-33-60, 31-33-28, 31-74-26,	GE778	20 Watt / 6 Volt - Halogen	L001005	\$10.00
B&L 31-33-04, 31-33-33, 31-33-34, 31-33-35,	GE787	20 Watt / 6 Volt - Halogen	L001014	\$10.00
B&L 31-74-28, Gallen II Tungston, 791667, 801624,	NI78508	30 Watt / 120 Volt - Halogen	L002834	\$28.00
B&L 31-33-07, 31-33-20, 31-33-59	BT1634	20 Volt - Incandescent	L004141	\$2.00
B&L 31-70-01	USBLK	30 Watt / 115 Volt - Incandescent	L002922	\$6.00
B&L, Sunnex, Welch Allyn, horizontal filament position	OS64425	20 Watt / 12 Volt - Halogen	L000880	\$4.00
Burton, Leitz	PHEKE	150 Watt / 21 Volt - Halogen	L001401	\$15.00
Jena, Leitz, Narva, Nikon, Olympus,	OS64610HLX	50 Watt / 12 Volt - Halogen	L000916	\$4.00
Jena, Leitz, Zeiss	OS64627HLX	100 Watt / 12 Volt - Halogen	L000928	\$9.00
Leica ATC2000	PH13528	150 Watt / 120 Volt - Incandescent	L000585	\$29.00
Leica OH, OH3, OH4	PEME300BF	300Watt - Xenon	LPEME300BF	\$740.00
Leitz Dialux20, Laborlux 12, Laborlux 12HLME,	GE778	20 Watt / 6 Volt - Halogen	L001005	\$10.00
Leitz PP600, Prado Universal, Pradovit 250, EHJ	OS64655HLX	250 Watt / 24 Volt - Halogen	L000940	\$3.00
Leitz, Nikon, Olympus, Unitron, Welch Allyn	OSEJA	150 Watt / 21 Volt - Halogen	L001369	\$10.00
Nikon Labophot, M Epi, Measurescope MM-11	OS64250HLX (ESB)	20 Watt / 6 Volt - Halogen	L000861	\$3.00

MEDICAL LAMPS	MFG/MODEL	LAMP TYPE	R&D PART	PRICE
<b>MICROSCOPE...continued</b>				
Nikon 6C2, V12, V16C, V20, V20A	OS64640HLX	150 Watt / 24 Volt - Halogen	L000935	\$3.00
Unitro Unimet MR1, Unimet MR2, Unimet MR3,	OS64640HLX	150 Watt / 24 Volt - Halogen	L000935	\$3.00
Nikon Alphaphot KT, KT2	PH7388	20 Watt / 6 Volt - Halogen	L000986	\$3.00
Olympus AHS, AHT, AHTM, AX70, AX80, BHS,	PHEVA	100 Watt / 12 Volt - Halogen	L001557	\$6.00
Olympus BH2, BH-DO	OP8G102	10 Watt / 6 Volt - Incandescent	L002837	\$14.00
Olympus BX40, BX41, CK30, CK40, CX31, CX40,	PH5761	30 Watt / 6 Volt - Halogen	L000808	\$7.00
Olympus BH2-RFL, BHMLSH2, IMT2-RFL	OSHBO100W2	100 Watt / 20 Volt - Mercury	L000256	\$167.00
Olympus AX70TRF, BH2-RFL, BH-RFL, IMT-RFL,	OSHBO103W2	100 Watt / 23 Volt - Mercury	L000257	\$185.00
Olympus SZH-LSGA	PH13528	15 Watt / 6 Volt - Halogen	L000584	\$25.00
Olympus CHT, CHZ,	USBLC	30 Watt / 115 Volt - Incandescent	L002922	\$6.00
Short Arc Mercury Fluorescence	OSHBO50WL1	50 Watt / 37 Volt - Mercury	L000268	\$187.00
Short Arc Mercury Fluorescence	OSHBO50WL2	50 Watt / 42 Volt - Mercury	L000269	\$187.00
Swift Y3 Base	WKEI737	6 Volt	L017359	\$12.00
Swift M10004D, M10005D, M3300D, M4002D,	GE778	20 Watt / 6 Volt - Halogen	L001005	\$10.00
Nikon	OS64250HLX (ESB)	20 Watt / 6 Volt - Halogen	L000861	\$3.00
Topcon	OS64261	30 Watt / 12 Volt - Halogen	L000865	\$16.00
Leica ATC2000	PH13529	9 Watt/6 Volt - Halogen	L000585	\$29.00
Zeiss OMPI FC	OS64627HLX	100 Watt / 12 Volt - Halogen	L000928	\$9.00
Zeiss OMPI PICO S/100	PH6834 (EFP)	101 Watt / 12 Volt - Halogen	L000964	\$10.00
Zeiss 3800-18-1740, EL77Z	WKEL77Z	15 Watt / 6 Volt - Incandescent	L052426	\$15.00
Zeiss	USJC6V10WH3G4	10 Watt / 6 Volt - Halogen	L002139	\$7.00
Zeiss 100/16, 125/16	BT53Z	25 Watt / 6 Volt - Incandescent	L002767	\$28.00
Zeiss UFMQR High Illuminato Series UFM	PHEVA	100 Watt / 12 Volt - Halogen	L000986	\$3.00
Zeiss	BT58Z	30 Watt / 6 Volt - Incandescent	L002768	\$18.00

### MISCELLANEOUS

B&L	WKBAB	20 Watt / 12 Volt - Halogen	L001093	\$2.00
Blacklight Blue, Woods Lamp, Leek Detection, Curing	WKF4T5CW	4 Watt - Fluorescent	L017383	\$2.00
Blacklight Blue, Woods Lamp, Leek Detection, Curing	WKF4T5BLB	4 Watt - Fluorescent	L002928	\$8.00
Billiblanck Ohmeda 0690-2100-315	CL70672	6 Watt / 120 Volt - Incandescent	LCL70672	\$6.00
Billiblanck Ohmeda 0208-0516-300	PHExZ	50 Watt / 120 Volt - Halogen	L001638	\$6.00
Spectroline Q12	WKF4T5BLB	4 Watt - Fluorescent	L002928	\$8.00
Collimator, Slide Projector	USCBX/CBS	75 Watt / 115 Volt - Incandescent	L016384	\$19.00
Datex Ohmeda Panda baby warmer	PHExN	50 Watt / 12 Volt - Halogen	L001584	\$6.00
Fisher/Transworld Projection Lamp	USBNF	75 Watt / 115 Volt - Incandescent	L065846	\$9.00
Flashlight Lamp (Min. 10/order)	WKPR2	1.38 Volt - Incandescent	L017432	\$1.00
General Lighting	BTJCD130V20WGBS	20 Watt / 130 Volt - Halogen	L005670	\$3.00
General Lighting - Circline (4 pin, 8" Deep)	GEFC8T9CW	22 Watt - Fluorescent	L009028	\$19.00
Projection	USBLX	50 Watt / 120 Volt - Incandescent	L016372	\$8.00
Projection, Microfilm	PHFLW	300 Watt / 24 Volt - Halogen	L001846	\$19.00
Projection, Microfilm	PH6834 (EFP)	100 Watt / 12 Volt - Halogen	L000964	\$10.00
Sunnex	WKFTC	20 Watt / 12 Volt - Halogen	L001930	\$2.00

Please call Customer Service if you do not see your lamp model listed.

More selections are available online at [www.rdbatteries.net](http://www.rdbatteries.net) or [www.rdbatteries.com](http://www.rdbatteries.com)



MEDICAL LAMPS	MFG/MODEL	LAMP TYPE	R&D PART	PRICE
<b>WELCH ALLYN SUBSTITUTES...continued</b>				
WA03700	CL2166	3.5 Volt	LCL2166	\$14.00
WA03800	CL1742	3.5 Volt	L066206	\$9.00
WA03900	CL1670	2.5 Volt	L048394	\$9.00
WA04100	CL1309	14.5 Volt	L006644	\$10.00
WA04400	CL1315	2.5 Volt	L029279	\$13.00
WA04700	CL894	2.5 Volt	L001041	\$6.00
WA04800	CL949	2.5 Volt	L001068	\$4.00
WA04900	CL995	3.5 Volt	L001074	\$15.00
WA06000	CL951	2.5 Volt	L001070	\$8.00
WA06100	CL1311	14.5 Volt	L029280	\$8.00
WA06200	CL1656	3.5 Volt	LCL1656	\$12.00
WA06500	CL1757	3.5 Volt	L078436	\$9.00
WA07800	CL1340	6 Volt	L029281	\$8.00
WA08200	CL1770	3.5 Volt	LCL1770	\$11.00
WA08300	CL1793	3.5 Volt	L067093	\$12.00
WA08800	CL1662	4.6 Volt	L036459	\$14.00

<b>OSRAM / SYLVANIA</b>				
20MR16FL35C	OS20MR16FL35C	20 Watt / 12 Volt - Halogen	L0048465	\$4.00
50T4QCLAX24A	OS50T4QCLAX24A	50 Watt / 24 Volt - Halogen	L000887	\$14.00
65248	OS65248	20 Watt / 12 Volt - Halogen	L000125	\$16.00
64440	OS64442	50 Watt / 12 Volt - Halogen	L000314	\$6.00
64225	OS64225	70 Watt / 24 Volt - Halogen	L000849	\$4.00
64250	OS6425	20 Watt / 6 Volt - Halogen	L000861	\$3.00
64251	OS64251	20 Watt / 6 Volt - Halogen	L000862	\$23.00
64260	OS64260	30 Watt / 12 Volt - Halogen	L000864	\$17.00
64261	OS64261	30 Watt / 12 Volt - Halogen	L000865	\$16.00
64450	OS64450	5 Watt / 12 Volt - Halogen	L000874	\$6.00
64415	OS64415	10 Watt / 12 Volt - Halogen	L000878	\$5.00
64425	OS64425	20 Watt / 12 Volt - Halogen	L000880	\$4.00
64425AX	OS64425AX	20 Watt / 24 Volt - Halogen	L000882	\$12.00
64435	OS64435	20 Watt / 24 Volt - Halogen	L000885	\$13.00
64450	OS64450	75 Watt / 12 Volt - Halogen	L000888	\$13.00
64450AX	OS64450AX	90 Watt / 12 Volt - Halogen	L000889	\$18.00
64460	OS64460	100 Watt / 24 Volt - Halogen	L000890	\$11.00
64615	OS64615	75 Watt / 12 Volt - Halogen	L000920	\$11.00
64623	OS61623	100 Watt / 12 Volt - Halogen	L000924	\$6.00
64625	OS64625(FCR)	100 Watt / 12 Volt - Halogen	L000926	\$3.00
64627	OS64627(EFP)	100 Watt / 12 Volt - Halogen	L000928	\$9.00
64634	OS64634(EFR)	150 Watt / 15 Volt - Halogen	L000931	\$9.00
64638	OS64638	100 Watt / 24 Volt - Halogen	L000934	\$11.00
64640	OS64640(FCS)	150 Watt / 24 Volt - Halogen	L000935	\$3.00
64642	OS64642	150 Watt / 24 Volt - Halogen	L000936	\$5.00
64650	OS64650	50 Watt / 23 Volt - Halogen	L000937	\$14.00
646502	OS646502	50 Watt / 23 Volt - Halogen	L045161	\$16.00
64655	OS64655HLX	250 Watt / 24 Volt - Halogen	L000940	\$3.00
BRL	OSBRL	50 Watt / 12 Volt - Halogen	L000916	\$4.00
DDL	OSDDL	150 Watt / 20 Volt - Halogen	L001192	\$10.00
DDS	OSDDS	80 Watt / 21 Volt - Halogen	L001204	\$10.00

MEDICAL LAMPS	MFG/MODEL	LAMP TYPE	R&D PART	PRICE
<b>OSRAM / SYLVANIA...continued</b>				
DNE	OSDNE	150 Watt / 120 Volt - Halogen	L001214	\$20.00
DNF	OSDNF	150 Watt / 21 Volt - Halogen	L001218	\$19.00
DZEFDS	OSDZEFDS	150 Watt / 24 Volt - Halogen	L001290	\$13.00
EJA	OSEJA	150 Watt / 21 Volt - Halogen	L001369	\$10.00
EJL	OSEJL	200 Watt / 24 Volt - Halogen	L001382	\$10.00
EJM	OSEJM	150 Watt / 21 Volt - Halogen	L001387	\$11.00
EJV	OSEJV	150 Watt / 21 Volt - Halogen	L001391	\$10.00
ENH	OSENH	250 Watt / 120 Volt - Halogen	L001462	\$11.00
ESR	OSESR	100 Watt / 120 Volt - Halogen	L001521	\$12.00
ETC	OSETC	150 Watt / 120 Volt - Halogen	L001542	\$14.00
GLF	OSGLF	235 Watt / 230 Volt - Halogen	L032735	\$26.00
EFPX	OSEFPX	100 Watt / 12 Volt - Halogen	L034451	\$14.00

Please call Customer Service if you do not see your lamp model listed.  
More selections are available online at [www.rdbatteries.net](http://www.rdbatteries.net) or [www.rdbatteries.com](http://www.rdbatteries.com)

MEDICAL LAMPS	LAMP NAME	LAMP TYPE	R&D PART	PRICE
<b>ANSI CODES</b>				
BAA	OSBAA	75 Watt / 28 Volt - Halogen	L001089	\$16.00
BAB	OS20MR16FL35C	20 Watt / 12 Volt - Halogen	L048465	\$4.00
BAB	WKBAB	20 Watt / 12 Volt - Halogen	L001093	\$2.00
BHB	USBHB	250 Watt / 120 Volt - Halogen	L001115	\$33.00
BLC	USBLC	30 Watt / 120 Volt - Incandescent	L002922	\$6.00
BLX	USBLX	50 Watt / 120 Volt - Incandescent	L016372	\$8.00
BMY	USBMY	100 Watt / 120 Volt - Incandescent	L016373	\$18.00
BRL	OS64610HLX	50 Watt / 12 Volt - Halogen	L000916	\$4.00
BZW	WKBZW	50 Watt / 120 Volt - Incandescent	L017312	\$7.00
CAX	OSCAX	50 Watt / 120 Volt - Halogen	L045201	\$11.00
CAX 130V	GECAX130V	50 Watt / 130 Volt - Incandescent	L002816	\$8.00
CDD	USCDD	100 Watt / 120 Volt - Incandescent	L016385	\$17.00
CDS/CDX	USCDS/CDX	100 Watt / 115/125 Volt - Incandescent	L016386	\$20.00
CXY	USCXY	300 Watt / 100 Volt - Incandescent	L034278	\$38.00
DDJ/DZZ	WKDDJ/DZZ	80 Watt / 10 Volt - Halogen	L001186	\$15.00
DDL	OSDDL	150 Watt / 20 Volt - Halogen	L001192	\$10.00
DDL	PHDDL	150 Watt / 20 Volt - Halogen	L001189	\$13.00
DDS	OSDDS	80 Watt / 21 Volt - Halogen	L001204	\$10.00
DED	OSDED	85 Watt / 13.8 Volt - Halogen	L001207	\$10.00
DNE	OSDNE	150 Watt / 120 Volt - Halogen	L001214	\$20.00
DNF	OSDNF	150 Watt / 21 Volt - Halogen	L001218	\$19.00
DNF	USDNF	150 Watt / 21 Volt - Halogen	L001217	\$24.00
DYR	USDYR	650 Watt / 230/240 Volt - Halogen	L001275	\$14.00
DYR220	USDYR220V	650 Watt / 220 Volt - Halogen	L001273	\$14.00
DZA	USDZA	30 Watt / 10.8 Volt - Halogen	L001286	\$18.00
DZE/FDS	OSDZE	150 Watt / 24 Volt - Halogen	L001290	\$13.00
EFM	OS64607	50 Watt / 8 Volt - Halogen	L000914	\$12.00
EFN	OS64615HLX	75 Watt / 12 Volt - Halogen	L000920	\$11.00
EFP	OS64627HLX	100 Watt / 12 Volt - Halogen	L000928	\$9.00
EFR	OS64634HLX	150 Watt / 15 Volt - Halogen	L000931	\$9.00
EHE	OS64626HLX	100 Watt / 24 Volt - Halogen	L000927	\$20.00
EHJ	OS64655HLX	250 Watt / 24 Volt - Halogen	L000940	\$3.00
EHT	OSEHT	250 Watt / 120 Volt - Halogen	L001362	\$17.00
EJA	OSEJA	150 Watt / 21 Volt - Halogen	L001369	\$10.00
EJL	OSEJL	200 Watt / 24 Volt - Halogen	L001382	\$10.00
EJM	OSEJM	150 Watt / 21 Volt - Halogen	L001387	\$11.00
EJV	OSEJV	150 Watt / 21 Volt - Halogen	L001391	\$10.00
EJY	USEJY	80 Watt / 19 Volt - Halogen	L001395	\$26.00
EKE	PHEKE	150 Watt / 21 Volt - Halogen	L001401	\$15.00
EKE	OSEKE	150 Watt / 21 Volt - Halogen	L001402	\$10.00
EKE	GEEKE	150 Watt / 21 Volt - Halogen	L001404	\$12.00
EKP/ENA	OSEKPENA	80 Watt / 30 Volt - Halogen	L001412	\$38.00
EKZ	USEKZ	30 Watt / 10.8 Volt - Halogen	L001414	\$17.00
EJY	USEJY	80 Watt / 18 Volt - Halogen	L001395	\$26.00
ELC	OS64653HLX	250 Watt / 24 Volt - Halogen	L000938	\$11.00
ELH	OSELH	300 Watt / 120 Volt - Halogen	L001434	\$9.00
ELZ	USELZ	150 Watt / 21 Volt - Halogen	L001444	\$23.00

MEDICAL LAMPS	LAMP NAME	LAMP TYPE	R&D PART	PRICE
<b>ANSI CODES</b>				
ENH	OSENH	250 Watt / 120 Volt - Halogen	L001462	\$11.00
ENL	GEENL	50 Watt / 12 Volt - Halogen	L001467	\$10.00
ENX	OSENX	360 Watt / 82 Volt - Halogen	L001481	\$8.00
ENZ	GEENZ	50 Watt / 30 Volt - Halogen	L001484	\$33.00
EPN	USEPN	35 Watt / 12 Volt - Halogen	L001487	\$17.00
EPN	WKEPN	36 Watt / 12 Volt - Halogen	L039619	\$18.00
EPV	USEPV	90 Watt / 14.5 Volt - Halogen	L028165	\$19.00
EPX	USEPX	90 Watt / 14.5 Volt - Halogen	L045915	\$31.00
EPZ	PHEPZ	50 Watt / 13.8 Volt - Halogen	L001501	\$15.00
ERB	BT1990	12 Watt / 12 Volt - Halogen	L004214	\$6.00
ESA/FHD	OS64250HLX	10 Watt / 6Volt - Halogen	L000859	\$4.00
ESA/FHD	PH7387	10 Watt / 6Volt - Halogen	L000985	\$4.00
ESB	OS64250HLX	20 Watt / 6 Volt - Halogen	L000861	\$3.00
ESB	PH7388	20 Watt / 6 Volt - Halogen	L000986	\$3.00
ESD	USESD	150 Watt / 120 Volt - Halogen	L001509	\$41.00
ESD	WKESD	151 Watt / 120 Volt - Halogen	L081591	\$25.00
ESJ	USESJ	85 Watt / 82 Volt - Halogen	L045918	\$31.00
ESP	USESP	150 Watt / 120 Volt - Halogen	L016426	\$13.00
ESR	OESER	100 Watt / 120 Volt - Halogen	L001521	\$12.00
ESS	USESS	250 Watt / 120 Volt - Halogen	L001525	\$15.00
ESX	GEQ20MR16SP12V	20 Watt / 12 Volt - Halogen	L002361	\$7.00
ESY	WKESY	150 Watt / 120 Volt - Halogen	L001537	\$12.00
ETC	OSETC	150 Watt / 120 Volt - Halogen	L001543	\$14.00
ETJ	USETJ	250 Watt / 120 Volt - Halogen	L001556	\$18.00
EVA	OS64623HLX	100 Watt / 12 Volt - Halogen	L000924	\$6.00
EVW	OSEVW	250 Watt / 82 Volt - Halogen	L001573	\$9.00
EXN	OS50MR16BFL35	50 Watt / 12 Volt - Halogen	L012629	\$10.00
EXR	OSEXR	300 Watt / 82 Volt - Halogen	L001606	\$9.00
EXT	OS50MR16SP10C	50 Watt / 12 Volt - Halogen	L048480	\$6.00
EXW	OSEXW	300 Watt / 82 Volt - Halogen	L001630	\$10.00
EXY	OSEXY	250 Watt / 82 Volt - Halogen	L001633	\$10.00
EXZ	PHEXZ	50 Watt / 12 Volt - Halogen	L001638	\$6.00
EYZ	PHEYC	75 Watt / 12 Volt - Halogen	L001664	\$5.00
EYP	USEYP	42 Watt / 12 Volt - Halogen	L001690	\$6.00
FCR	OS64625HLX	100 Watt / 12 Volt - Halogen	L000926	\$3.00
FDS/DZE	OSEDZ	150 Watt / 24 Volt - Halogen	L001290	\$13.00
FDT	OS64628HLX	100 Watt / 12 Volt - Halogen	L000929	\$12.00
FDV	OS64642HLX	150 Watt / 24 Volt - Halogen	L000936	\$5.00
FHD	OS64225	10 Watt / 6 Volt - Halogen	L000859	\$4.00
FHS	OSFHS	300 Watt / 82 Volt - Halogen	L001823	\$9.00
FJX	USFJX	30 Watt / 13.8 Volt - Halogen	L001828	\$21.00
FMT	WKFMT	35 Watt / 12 Volt - Halogen	L001852	\$2.00
FMW	WKFMW	35 Watt / 12 Volt - Halogen	L001859	\$2.00
FRAC	GEFRAC	35 Watt / 12 Volt - Halogen	L001899	\$13.00
FRA	EYFRA	35 Watt / 12 Volt - Halogen	L001898	\$4.00
FXL	OSFXL	410 Watt / 82 Volt - Halogen	L001963	\$9.00
GLF	OPSGLF	235 Watt / 230 Volt - Halogen	L032735	\$26.00

MEDICAL LAMPS	LAMP NAME	LAMP TYPE	R&D PART	PRICE
<b>ANSI CODES</b>				
BAA	OSBAA	75 Watt / 28 Volt - Halogen	L001089	\$16.00
BAB	OS20MR16FL35C	20 Watt / 12 Volt - Halogen	L048465	\$4.00
BAB	WKBAB	20 Watt / 12 Volt - Halogen	L001093	\$2.00
BHB	USBHB	250 Watt / 120 Volt - Halogen	L001115	\$33.00
BLC	USBLC	30 Watt / 120 Volt - Incandesent	L002922	\$6.00
BLX	USBLX	50 Watt / 120 Volt - Incandesent	L016372	\$8.00
BMY	USBMY	100 Watt / 120 Volt - Incandesent	L016373	\$18.00
BRL	OS64610HLX	50 Watt / 12 Volt - Halogen	L000916	\$4.00
BZW	WKBZW	50 Watt / 120 Volt - Incandesent	L017312	\$7.00
CAX	OSCAX	50 Watt / 120 Volt - Halogen	L045201	\$11.00
CAX 130V	GECAX130V	50 Watt / 130 Volt - Incandesent	L002816	\$8.00
CDD	USCDD	100 Watt / 120 Volt - Incandesent	L016385	\$17.00
CDS/CDX	USCDS/CDX	100 Watt / 115/125 Volt - Incandesent	L016386	\$20.00
CXY	USCXY	300 Watt / 100 Volt - Incandesent	L034278	\$38.00
DDJ/DZZ	WKDDJ/DZZ	80 Watt / 10 Volt - Halogen	L001186	\$15.00
DDL	OSDDL	150 Watt / 20 Volt - Halogen	L001192	\$10.00
DDL	PHDDL	150 Watt / 20 Volt - Halogen	L001189	\$13.00
DDS	OSDDS	80 Watt / 21 Volt - Halogen	L001204	\$10.00
DED	OSDED	85 Watt / 13.8 Volt - Halogen	L001207	\$10.00
DNE	OSDNE	150 Watt / 120 Volt - Halogen	L001214	\$20.00
DNF	OSDNF	150 Watt / 21 Volt - Halogen	L001218	\$19.00
DNF	USDNF	150 Watt / 21 Volt - Halogen	L001217	\$24.00
DYR	USDYR	650 Watt / 230/240 Volt - Halogen	L001275	\$14.00
DYR220	USDYR220V	650 Watt / 220 Volt - Halogen	L001273	\$14.00
DZA	USDZA	30 Watt / 10.8 Volt - Halogen	L001286	\$18.00
DZE/FDS	OSDZE	150 Watt / 24 Volt - Halogen	L001290	\$13.00
EFM	OS64607	50 Watt / 8 Volt - Halogen	L000914	\$12.00
EFN	OS64615HLX	75 Watt / 12 Volt - Halogen	L000920	\$11.00
EFP	OS64627HLX	100 Watt / 12 Volt - Halogen	L000928	\$9.00
EFR	OS64634HLX	150 Watt / 15 Volt - Halogen	L000931	\$9.00
EHE	OS64626HLX	100 Watt / 24 Volt - Halogen	L000927	\$20.00
EHJ	OS64655HLX	250 Watt / 24 Volt - Halogen	L000940	\$3.00
EHT	OSEHT	250 Watt / 120 Volt - Halogen	L001362	\$17.00
EJA	OSEJA	150 Watt / 21 Volt - Halogen	L001369	\$10.00
EJL	OSEJL	200 Watt / 24 Volt - Halogen	L001382	\$10.00
EJM	OSEJM	150 Watt / 21 Volt - Halogen	L001387	\$11.00
EJV	OSEJV	150 Watt / 21 Volt - Halogen	L001391	\$10.00
EJY	USEJY	80 Watt / 19 Volt - Halogen	L001395	\$26.00
EKE	PHEKE	150 Watt / 21 Volt - Halogen	L001401	\$15.00
EKE	OSEKE	150 Watt / 21 Volt - Halogen	L001402	\$10.00
EKE	GEEKE	150 Watt / 21 Volt - Halogen	L001404	\$12.00
EKP/ENA	OSEKPENA	80 Watt / 30 Volt - Halogen	L001412	\$38.00
EKZ	USEKZ	30 Watt / 10.8 Volt - Halogen	L001414	\$17.00
EJY	USEJY	80 Watt / 18 Volt - Halogen	L001395	\$26.00
ELC	OS64653HLX	250 Watt / 24 Volt - Halogen	L000938	\$11.00
ELH	OSELH	300 Watt / 120 Volt - Halogen	L001434	\$9.00
ELZ	USELZ	150 Watt / 21 Volt - Halogen	L001444	\$23.00



MEDICAL LAMPS	LAMP NAME	LAMP TYPE	R&D PART	PRICE
<b>ANSI CODES</b>				
ENH	OSENH	250 Watt / 120 Volt - Halogen	L001462	\$11.00
ENL	GEENL	50 Watt / 12 Volt - Halogen	L001467	\$10.00
ENX	OSENX	360 Watt / 82 Volt - Halogen	L001481	\$8.00
ENZ	GEENZ	50 Watt / 30 Volt - Halogen	L001484	\$33.00
EPN	USEPN	35 Watt / 12 Volt - Halogen	L001487	\$17.00
EPN	WKEPN	36 Watt / 12 Volt - Halogen	L039619	\$18.00
EPV	USEPV	90 Watt / 14.5 Volt - Halogen	L028165	\$19.00
EPX	USEPX	90 Watt / 14.5 Volt - Halogen	L045915	\$31.00
EPZ	PHEPZ	50 Watt / 13.8 Volt - Halogen	L001501	\$15.00
ERB	BT1990	12 Watt / 12 Volt - Halogen	L004214	\$6.00
ESA/FHD	OS64250HLX	10 Watt / 6Volt - Halogen	L000859	\$4.00
ESA/FHD	PH7387	10 Watt / 6Volt - Halogen	L000985	\$4.00
ESB	OS64250HLX	20 Watt / 6 Volt - Halogen	L000861	\$3.00
ESB	PH7388	20 Watt / 6 Volt - Halogen	L000986	\$3.00
ESD	USESD	150 Watt / 120 Volt - Halogen	L001509	\$41.00
ESD	WKESD	151 Watt / 120 Volt - Halogen	L081591	\$25.00
ESJ	USESJ	85 Watt / 82 Volt - Halogen	L045918	\$31.00
ESP	USESP	150 Watt / 120 Volt - Halogen	L016426	\$13.00
ESR	OESER	100 Watt / 120 Volt - Halogen	L001521	\$12.00
ESS	USESS	250 Watt / 120 Volt - Halogen	L001525	\$15.00
ESX	GEQ20MR16SP12V	20 Watt / 12 Volt - Halogen	L002361	\$7.00
ESY	WKESY	150 Watt / 120 Volt - Halogen	L001537	\$12.00
ETC	OSETC	150 Watt / 120 Volt - Halogen	L001543	\$14.00
ETJ	USETJ	250 Watt / 120 Volt - Halogen	L001556	\$18.00
EVA	OS64623HLX	100 Watt / 12 Volt - Halogen	L000924	\$6.00
EVW	OSEVW	250 Watt / 82 Volt - Halogen	L001573	\$9.00
EXN	OS50MR16BFL35	50 Watt / 12 Volt - Halogen	L012629	\$10.00
EXR	OSEXR	300 Watt / 82 Volt - Halogen	L001606	\$9.00
EXT	OS50MR16SP10C	50 Watt / 12 Volt - Halogen	L048480	\$6.00
EXW	OSEXW	300 Watt / 82 Volt - Halogen	L001630	\$10.00
EXY	OSEXY	250 Watt / 82 Volt - Halogen	L001633	\$10.00
EXZ	PHEXZ	50 Watt / 12 Volt - Halogen	L001638	\$6.00
EYZ	PHEYC	75 Watt / 12 Volt - Halogen	L001664	\$5.00
EYP	USEYP	42 Watt / 12 Volt - Halogen	L001690	\$6.00
FCR	OS64625HLX	100 Watt / 12 Volt - Halogen	L000926	\$3.00
FDS/DZE	OSEDZ	150 Watt / 24 Volt - Halogen	L001290	\$13.00
FDT	OS64628HLX	100 Watt / 12 Volt - Halogen	L000929	\$12.00
FDV	OS64642HLX	150 Watt / 24 Volt - Halogen	L000936	\$5.00
FHD	OS64225	10 Watt / 6 Volt - Halogen	L000859	\$4.00
FHS	OSFHS	300 Watt / 82 Volt - Halogen	L001823	\$9.00
FJX	USFJX	30 Watt / 13.8 Volt - Halogen	L001828	\$21.00
FMT	WKFMT	35 Watt / 12 Volt - Halogen	L001852	\$2.00
FMW	WKFMW	35 Watt / 12 Volt - Halogen	L001859	\$2.00
FRAC	GEFRAC	35 Watt / 12 Volt - Halogen	L001899	\$13.00
FRA	EYFRA	35 Watt / 12 Volt - Halogen	L001898	\$4.00
FXL	OSFXL	410 Watt / 82 Volt - Halogen	L001963	\$9.00
GLF	OPSGLF	235 Watt / 230 Volt - Halogen	L032735	\$26.00

**R&D BATTERIES, INC.**  
P.O. BOX 5007, BURNSVILLE, MN 55337  
TELEPHONE (952) 890-0629

PRESORTED  
BOUND PRINTED MATTER  
US POSTAGE PAID  
PERMIT NO. 185  
BURNSVILLE MN

For all your battery requirements, call . . .

**1.800.950.1945**

**rdbatteries.com**